

Buyers

PRODUCTS COMPANY



A LEADING MANUFACTURER DELIVERING QUALITY, VALUE & AVAILABILITY



ROTATIONAL MOLDING



POWDER COATING



ROBOTIC WELDING



RUBBER PROCESSING



LASER CUTTING

TOWING & CARGO | TRUCK BOXES | TRUCK & TRAILER | LIGHTING | HYDRAULICS | ACCESSORIES

Our History

1946
 Buyers Products Company founded by Sam Ruven and Bessie Kleinman as a distributor of driveline components.

Tracom

1992
 Buyers acquired Trailer Components Manufacturing (Tracom) for CNC precision machining and tooling, as well as state-of-the-art welding.

Buyers
 PRODUCTS COMPANY

2002
 Buyers moved its corporate headquarters to a brand new 235,000 sq. ft. state-of-the-art office and distribution center.

SnowDogg
 Buyers

2007
 Buyers began manufacturing the SnowDogg stainless steel snowplow at our Mentor, Ohio facility.

Buyers
 PRODUCTS COMPANY

2013
 Buyers acquired an additional 500,000 sq.ft. manufacturing facility in Mentor, Ohio allowing for expansion of our aluminum and stainless steel manufacturing.

SaltDogg
 Buyers

**ALL YOUR WORK
 TRUCK PRODUCTS
 ALL THE TIME.**

2017
 Buyers launches new website with business partner portal, to make online ordering and account maintenance easy for customers.

Buyers

Buyers continued to grow its product offerings and build valued relationships with customers and suppliers. Increased demand for products led to the pursuit of supply chain manufacturing solutions.

**PROGRESSIVE
 POWDER COATING, INC.**

1995
 Buyers acquired Progressive Powder Coating. Our Nordson automatic powder application booth is used to powder coat our Buyers toolboxes and other truck and trailer accessories.

Romotech
 Rotational Molding Technologies, Inc.

2004
 Buyers acquired Romotech in New Paris, Indiana. Our Ferry Industries Rotospeed molding machines are used to manufacture our poly salt spreaders.

**Boomerang
 RUBBER, INC.**

2009
 Buyers began our operations at Boomerang Rubber, in Botkins, Ohio manufacturing mudflaps, wheel chocks and other rubber truck and trailer accessories.

Buyers
 PRODUCTS COMPANY

2016
 Buyers establishes a 22,000 sq ft Engineering Tech Center in Mentor, Ohio. It's multi-use lab, design, training and prototyping space is dedicated to the research and development of innovative product.



Our Corporate Family of Companies



Founded in 1946, Buyers Products is a fully integrated manufacturer and a leader in the truck equipment industry. Our engineering, manufacturing and assembly operations take place in the USA, under the Buyers family of companies. **Buyers Products' mission is to improve our Customers' profitability and productivity while enhancing the quality of our products and services.**



Join thousands who have discovered the easiest way to do business with Buyers!

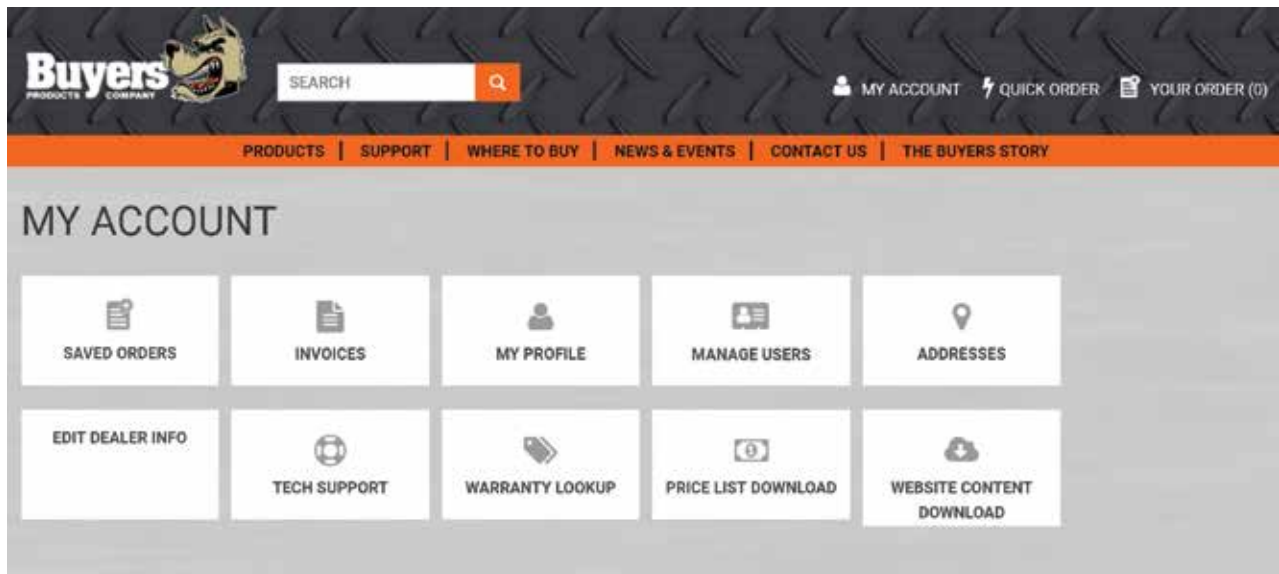

Online Business Partner Access

- Find product information for over 5,000 products.
- Get your personalized prices and product availability.
- Place your orders and check order status.
- Download manuals and access tech support.
- Download product cut sheets.

It's Easy to Join

1. From the home page, click *“Login or Register”* and select *“Create A User”*
2. Enter your account number and a recent invoice number, and proceed through the registration forms. (Both your account number and a recent invoice number are available on any recent Buyers Products invoice.)

Customer Support

Ordering:

Email: orders@BuyersProducts.com

24 Hour Toll-Free Fax: (800) 841-8003

Phone: (440) 974-8888

Customer Service:

For customer service information, call us at (440) 974-8888,

email us at CustomerCare@BuyersProducts.com,

or visit BuyersProducts.com

Hours:

- Monday – Thursday from 8:00 AM to 6:00 PM EST, Friday from 8:00 AM to 5:30 PM EST
- You are always welcome to place an order or leave a message after hours.

Payment Terms:

Open account terms are net 30 days, with approved credit. MC[®] and VISA[®] accepted.

Freight:

- Buyers' "Preferred LTL Program" incorporates preferred carrier rates, pre-paid and added to your invoice.
- Shipments are F.O.B. Mentor, Ohio.
- Drop-ship orders less than \$125.00 will incur a \$20.00 handling fee.

Returns:

Contact our Customer Service for authorization and information.

Returns may be subject to a restocking fee.

Pricing:

Pricing is consistent with current market conditions and is subject to change without notice.

Marketing Information:

Looking for images, ad templates or have something to share with us online?

Drop us an email at Marketing@buyersproducts.com.

Additional Product Information:

Manuals, instructions, videos and other product details can be found at www.BuyersProducts.com.

TABLE OF CONTENTS	PAGE
CUSTOMER SUPPORT	i
PRODUCT LOCATOR	iv-v
NEW PRODUCT SHOWCASE	vi-viii
TRUCK BOXES	A1-A24
TOWING	B1-B46
LIGHTING	C1-C66
ELECTRICAL	D1-D10
TRUCK EQUIPMENT & ACCESSORIES	E1-E34
TARP SYSTEMS	F1-F14
CARGO CONTROL	G1-G16
TRUCK & TRAILER HARDWARE	H1-H46
HYDRAULICS	I1-I56
PNEUMATICS	J1-J10
CABLES & CONTROLS	K1-K22
PTO DRIVELINE	L1-L14
INDUSTRY GLOSSARY, WARRANTY POLICY & INDEX	M1-M18

Product Locator

PRODUCT	PAGE NO.	PRODUCT	PAGE NO.	PRODUCT	PAGE NO.	PRODUCT	PAGE NO.
A							
Assemblies, Universal Joint	L2-L8	Chain Carrier	A19	DumperDogg Dump Inserts & Accessories	E2	Hitch Balls	B25, B26
Accessories, Cable & Controls	K17,K18	Chain Eyes	H44	Dump Tarps Kits	F2-F11	Hitch Pins	B27
Landscape Trailer		Chain Hardware	B28	E			
Accessories	E12-E15	Chain Holder	A19	Electric Jack	B44-B46	Hitch Receivers	B17,B18
Air Controls		Chain, Trailer Towing	B27	Electric Motors	D7-D8	Hitch Plates	B15,B16
Air Filter/Regulator/Lubricator	J7	Chests, Toolbox	A14	Electric Tarp Kits	F2-F5	Hitches, Multi-fit	B17
Air Fittings & Tube	J9, J10	Circuit Breakers	D7	Electric Winches	E6	Hitches, Service Body	B17-B18
Air Tailgate Cylinders	H39	Clamps, Cylinder	E16	Electrical	D1	Holder, Shovel	H42
Air Valves	H40	Clamps, Hose	I48-I50	Electrical Connectors	B38-B42	Hood Catches, Rubber	H17-H19
Anchor Eye Bolts	G15	Clamps, Rubber	E16	Electrical Harness Assemblies	C63	Hooks, Tarp	F14
Anchor Shackles	G9	Clevises	H31	Electrical Solenoids	D8	Hooks, Towing	B31-B32
Anti-Skid Tape	H8	Clutch Pumps	I21-I24	Electrical Switches/Relays	D5, D6	Hooks, Weld-on	B31
ATV Spreader	E5	Coal Door / Inspection Door	H41	Emergency Road Flares	D4	Hose Clamp, Hydraulic	I48-I50
B							
Backpack Truck Boxes	A20-A24	Compression Latch	H12	E-Track & Accessories	G14	Hose Reels	J7
Back-Up Alarm	D3	Conduit Carrier Kit	E11	Eye Bolts	G9	Hose, Hydraulic	I41
Backup Cameras	D2, D3	Cone Holders	E16	Eye Hooks	B37-B38	Hour Meter	D9
Backup Lights, DOT	C51-C58	Connection Kits/PTO/Pump	K12	EZ Gate	E15	Hydraulic Couplers	I38-I41
Ball Hitches / Pintle Hooks	B2, B19	Connectors, Trailer	B38-B42	F			
Ball Joints	K20	Consoles & Shifters	K9	Fender Extension, Rubber	E19	Hydraulic Filters	I43-I47
Ball Mounts	B23-B25	Conspicuity Tape	C61	Fender Mounting Kit	E19	Hydraulic Fittings	I51-56
Ball Valves, Hydraulic	I33	Continuous Hinge	H21	Fenders	E18	Hydraulic Gauges	I18
Balls, Towing	B25	Contractor Truck Boxes	A14	Fifth Wheel Lube Disks	B12	Hydraulic Motors	I25,I26
Banjo Eyes	H44	Controls, Dump	J2, K6	Filters, Hydraulic	I43-I46	Hydraulic Pumps	I21
Battery Bolt Adapter	D9	Controls, Plow	K9, I28	Fittings, Air	J9, J10	Hydraulic Reservoirs	I4-I11
Battery Disconnects	D9	Controls, Spreader	I37	Fittings, Hydraulic	I51-I55	Hydraulic Valves	I30-I37
Battery operated beacon	C41	Corner Iron	H11	Flange, Bearings	L14	Hydraulics	I1
Beacon Strobes	C39-44	Coupler Locks	B34	Flanges, Hydraulic	I14	I	
Bearings, Pillow Block	L12, L13	Couplers, Hydraulic	I38-I40	Flare, Road, LED	D4	ICC Bumper	B16
Body-Up Indicator	H45, H46	Couplers	B33-B35	Flasher, Strobe Light	C16, D3	Inspection Door/Coal Door	H41
Booster Cables	D4	Crank Arm Tarp Systems	F8	Flood Lights	C45	J	
Bottle Holders	E16	Crossover Truck Boxes	A16-A17	Flow Control Valve	I34	Jacks, Trailer	B44-B46
B-Pack Toolboxes	A20-A24	Cylinder Clamps	E16	Flow Divider Valve	I34	J-Hooks	A20, F12, G14, H33
Brackets, Toolbox	A9	D				Jumper Cables	D4
Brackets, Beacon Light	C43	Dash Mounted Strobe	C26	Junction Box	D5	K	
Brake Controllers	B37	Diamond Deck-Span Tread	H8	Kabgard	E7	Key Stock	L9
Branch Guard	C43	Directional Strobes	C26	King Pin	B12	King Pin Lock	B12
Breakaway Switch	B37	Document Holder	E17	King Pin Lock	B12	Knobs	K17, K18
Breather Caps	I15	Dome Lights	C17	L			
Bulkhead Tanks	I6	Door Cam Lock	H28	Ladder Racks	E8-E10	Landscape Trailer	E12
Bumper, ICC	B16	Door Holders	H26, H27	Lashing Winch	G11	Latches	H11-H19
Bumpers, Rubber	H47-H49	Door Locks	H12-H14, H28	Lights	C2-C62	LED Lights	C2-C62
Bumper Guides	E24	Door Springs/Gas Springs	H27	LED Road Flares	D4	LED Road Flares	D4
Buzzer Light	H46	Doors, Aluminum, Cast	E11	Levers, Dump	J2, J4, J6, K8-K9, K14	Levers, Plow	K6
C							
Cab Guard	E7, E8	Doors, Inspection/Coal	H41	Levers, Warning	C19-C43	Lift Axle Controller	J8
Cabinets	A18	DOT Air Fittings	J9, J10	LiftDogg Lift Gates	E4	Lighting	C1
Cables & Control Systems	K1	DOT Incandescent	C45-C58	Lights	C1-C66	Light Bars	C13-C15, C19-26
Cables, Control	K3	DOT LED	C44-C58	Light Boxes	C62-C66	Light Brackets	C21, C25, C26
Cables, Push-Pull	K10, K11	Drain Valve, Air	J8	Lights	C1-C66	Lights	C1-C66
Cable Steps	H8	Drawbar Eyes	B36	Lights, Beacons	C39-43	Lights, DOT	C44-C58
Cable Ties	K22	Drawbars	B36	Lights, Warning	C19-C43	Lights, Work	C2-C15
Cambuckle Straps	G13-G16	Drill-Free Lightbar Mounts	C25-C26	H			
Cameras, Backup	D2, D3	D-Rings	G2-G7	Handles	H11-H14	Hanger Bearings	L13
Cargo Control	G1	Driveline Components	L2-L8	Harness Assemblies	C63	Hat, Knit	E34
Central Hydraulic Systems	I2	Driveshaft Assemblies	L2-L8	Hasp, Lock	H14, H29	Headache Rack	E8
		Dry Mat	A11	Hat, Knit	E34	Hinges, Piano, Butt	H20-H25
		Dump Body Hardware	H39-H46	Hitch Accessories	B30	Hitch Adapters/Extensions	B10,B21
		Dump Body Vibrators	H41	Hitch Adapters/Extensions	B10,B21		
		Dump Consoles	K16				

PRODUCT	PAGE NO.	PRODUCT	PAGE NO.	PRODUCT	PAGE NO.	PRODUCT	PAGE NO.
Limit Switches	H46	Racks, Ladder	E8-E10	Stake Pocket D-ring	G3, H6	Trailer Breakaway Switch.....	B37
Linch Pins	H30	Ramp Kit	H17	Stake Pockets	H5	Trailer Connectors.....	B38-B42
Liner Slat.....	H4	Ramp Spring	H27	Step Box.....	A19	Trailer Tongue Toolboxes.....	A17
Lo-Sider Truck Boxes.....	A15	Ratchet Straps	G13-G16	Step Grip.....	H8	Tri-Ball Hitches.....	B19
Load Binders.....	G9	Ratcheting Load Binders.....	G9	Step, Folding.....	H7	Trimmer Racks.....	E12-E14
Lock Cylinders	H14	Rearview Camera Systems.....	D2,D3	Step, Pickup, Aluminum	H8	Truck & Trailer Hardware	H1
Lock Hasp.....	H14, H29	Reflective Tape.....	C61	Step, Poly.....	H9	Truck Boxes	A1
Locks	H14, H29	Receiver Tubes.....	B21, B22	Steps, Cable.....	H8	Truck Boxes, Backpack.....	A20-A22
Lube Disks	B12	Receivers	B17, B18	Steps, Retractable.....	H9, H10	Truck Boxes, Crossover.....	A16-A17
Lunette Eye.....	B13	Reels, Hose	J7	Stone Guards	E23	Truck Boxes, Lo-Siders	A15
M							
Manual Tarp Kits.....	F8-F11	Regulators.....	J7, J8	Stop/Turn/Tail Lights, DOT C49-C54		Truck Boxes, Slide Out Bed	A19
Marker/Clearance Lights, DOT...C42		Relief Valves.....	I35	Storage Tanks	E25, E26	Truck Boxes, Topsiders	A12-A14
Master Disconnect Switch	D9	Relay, Motor, Tarp,	F7	Storage Trays	A10, E13	Truck Boxes, Trailer Tongue	A23
Motorcycle Wheel Chocks.....	E33	Remote Valve Control Systems...K15		Storage, Box	A14, A17, A18	Truck Boxes, Underbody	A2-A11
Motors, 12 VDC.....	D7, D8	Reservoirs, Hydraulic	I4-I11	Strainers, Hydraulic.....	I15	Truck Box Mounting Brackets	A9
Motors, Hydraulic.....	I20	Retractable Steps.....	H9, H10	Straps, Winch, Ratchet.....	G11-G16	Truck Racks	E7-E11
Mud Flap Brackets, Mounts.....	E22	Retractable Tie-Down.....	G13-G16	Strip Lights, LED	C16	Truck/Trailer Lights.....	C44-C58
Mud Flaps	E20, E21	Return Line Manifold.....	I42	Strobe Lights.....	C19-C43	Turn Signals, Lights.....	C49-C56
Multi-Ball Hitches.....	B19, B20	Ring & Chain	H43	Super Track.....	G14	U	
N							
Non-Slip Tape	H8	Road Flares,LED.....	D4	Suspension Kits	H38	U-Bolt Kits.....	H2
O							
Object Detection Systems.....	D2, D3	Roadside Assistance Equipment..D4		Sway Control.....	B30	U-Joints	L2
Outrigger Pads	E27	Rod End Bearings.....	K20, K21	Switch Boxes	D5	Underbody Toolboxes	A2-A8
Outriggers, Trailer	G10	Rod Ends, Forged.....	H29	Switch Panels	D5	Universal Joint Assemblies	L2-L8
P							
Paddle Latches.....	H12-H14	Roll Tarps	F10	Switches, Limit	H46	Utility Light.....	C59-C60
Piano Hinge.....	H21	Rope lights, LED.....	C18	Switches, Momentary	D6	Utility Step.....	H9
Pickup Hitches	B2-B9	Rope Rings.....	G5-G8	Switches, Toggle.....	D6	UTV spreader	E5
Pickup Racks	E8-E10	Rubber Bumpers	H47-H49	Switches, Master Disconnect	D9	V	
Pillow Blocks.....	L12	Rubber Clamps.....	E16	T			
Pin, Clevis	H31	Rubber Hood Catches	H17, H18	Tail Light Converters	B50	Valve Control Systems	K14-K16
Pins, Linch	H30	RV/Travel Trailer		Tailgate Cylinders.....	H39	Valves, Air	J2, J6
Pintle Hooks	B2-B9	Hitches.....	B2-B4, B19, B20	Tailgate Hinge, Bracket	H42, H43	Valves, Hydraulic.....	I30-I37
Pintle Mounts	B5	S					
Plastic Mat.....	All	Safety & Emergency		Tailgate Lift Assist.....	E15	Van Racks, Ladder Carriers...E9-E12	
Pneumatics	J1	Lighting.....	C19-C43	Tandem Fenders	E18	Van Security.....	H14, H29
Pneumatic Valves.....	J2, J4, J6	Safety Chain Retainers.....	B28	Tank Holders	E13, E17	Vernier Cables.....	K2
Pneumatic Tailgate Cylinders.....	H39	Safety Chain, Trailer	B28	Tanks, Storage.....	E25, E26	Vibrators, Dump Body	H20
Power Units, Hydraulic	I52-I54	Safety Chain, Trailer	B28	Tanks, Hydraulic.....	I4-I11	Video Safety Systems	D2
Pressure Regulator.....	J7, J8	Sectional Valves.....	I31, I32	Tanks, Poly.....	E4	Voltage, Low, Shutdown.....	D6-D8
Programmable Switches	D5, D6	Set Screws.....	L9	Tanks, Water	E25, E26	W	
PTO Cables	K5	Shafting & Accessories	L4	Tarp Gear Motor	F7	Water Cooler Holder	E13,E17
PTO Connection Kits	K12	Shifters, Push-Pull	K6-K9	Tarp Kits.....	F2-F6	Water Tanks, Storage.....	E25, E26
PTO's	I20	Shovel Holder.....	H42	Tarp Straps	F12	Warning Lights	C19
Pull-Style Tarp kits.....	F9	Sight Gauge	I18	Tarp Winder.....	F6, F10	Weight Distributing Hitch.....	B30
Pump Cables.....	K5	Sight Rods.....	E24	Tarps	F7	Weld Flange	G10
Pump Connection Kits.....	K13	Slide Out Truck Bed Boxes	A19	T-Bolt Clamp	I50	Wetline Kits.....	I12-I13
Pumps, Hydraulic	I21	Smart Switches.....	D5, D6	Temperature Gauges.....	I6	Wheel Chocks	E28-E33
Push-Button, Recessed	D6	Snap Pins.....	H30	T-Handle Latches	H212	Winches & Tie Downs	G11-G16
Push-Pull Cables.....	K10, K11	Solenoids	D8	Throttle Cables.....	K2	Winches, Electric.....	E6
Q							
Quick Couplers.....	I38-I40	Spare Tire Carrier.....	E17, H6	Tie Bars.....	H29	Window Protector.....	E8
Quick Ties	G16	Splash Guards.....	E23	Tie Downs	G9-G16	Wire Harness, Universal	C63
R							
Racks, Blower/Trimmer.....	E12, E13	Splined Stub Insert.....	L9	Tie Rings	G5-G8	Work Apparel	E34
		Spot Lights...C2-C8, C10, C11,C13-C15		Tire Carrier, Spare	E17	Work Gloves.....	E34
		Spreader Valves	I37	Toolboxes	A1-A24	Work Lights.....	C2-C15
		Spreaders, All-Season/ATV.....	E5	Topsider Truck Boxes	A12-A14	X	
		Spring Latches.....	H15, H16	Tow Hooks	B31, B32	XD Truck Boxes	A2-A-3
		Spring Ramp, Torsion.....	E15	Towing	B1	Y	
		Springs, Tarp.....	F6	Towing Lights.....	D4	Yokes, Adjustable End.....	H32-H34
		Stake Body Hardware	H3-H6	Traffic Arrow Lights	C26		
		Stake Connectors.....	H4	Traffic Cone Holder	E16		

**SMOOTH ALUMINUM
XD UNDERBODY WITH
DIAMOND TREAD
DROP DOWN DOOR**



PAGE A3

**TEXTURED MATTE
BLACK ALUMINUM
UNDERBODY**



PAGE A4

**STEEL UNDERBODY
WITH
T-LATCH AND SHELF**



PAGE A7

**TEXTURED MATTE
BLACK STEEL
UNDERBODY**



PAGE A8

**TOPSIDER ALUMINUM
SMOOTH & TEXTURED
MATTE BLACK
DIAMOND TREAD**



PAGE A12

**FLIP UP DOOR
ALUMINUM TOPSIDER**



PAGE A13

**TEXTURED MATTE
BLACK ALUMINUM
LO-SIDER/RAIL**



PAGE A15

**TEXTURED MATTE
BLACK ALUMINUM
CROSSOVER
GULL WING**



PAGE A16

**TEXTURED MATTE
BLACK ALUMINUM
STORAGE CHEST**



PAGE A18

**6 TON AND 10 TON
PINTLE HOOKS**



PAGE B3

**PINTLE HOOK
MOUNT STYLES**



PAGE B5

**RECEIVER TUBE
ADAPTER STYLES**



PAGE B21

**2-1/2" HEAVY DUTY
FORGED BALL
MOUNTS**



PAGE B24

**BLACK POWDER
COATED CAST COUPLER
WITH NO CHANNEL**



PAGE B35

**7-WAY ROUND TO
4-WAY FLAT TRAILER
CONNECTOR ADAPTER**



PAGE B41

**ULTRA BRIGHT LED
ARTICULATING FLOOD
AND SPOT LIGHT**



PAGE C2

WIDE ANGLE 4" LED COMBINATION SPOT/FLOOD LIGHT



PAGE C6

ULTRA BRIGHT 6.5" LED FLOOD LIGHT



PAGE C8

3-LED SURFACE/ RECESS STROBES



PAGE C12

96-132" LED STRIP LIGHTS CLEAR & COOL



PAGE C16

18-48" LED TUBE LIGHTS



PAGE C16

FLEET SERIES DRILL-FREE LIGHT BAR CAB MOUNT



PAGE C25

ULTRA THIN WIDE ANGLE 5" LED STROBE



PAGE C28

ULTRA BRIGHT NARROW PROFILE 5" LED STROBE



PAGE C33

TRIPLE-ROW 4.5" LED STROBE



PAGE C35

QUAD-ROW 4.75" LED STROBE



PAGE C35

CRUSH RESISTANT LED STROBE KIT



PAGE C36

SAE J595 CLASS 1 LED BEACONS



PAGE C39

5.5" PORTABLE LED BEACON



PAGE C41

BEACON MOUNTING BRACKET STYLES



PAGE C43

17" SLIMLINE STOP/TURN/TAILED LED LIGHT



PAGE C49

4" ROUND & 6" OVAL COMBINATION STOP/TURN/TAILED & BACKUP LED LIGHT



PAGE C50-C52

5" BOX-STYLE STOP/TURN/TAIL LED LIGHT



PAGE C54

2-3/8" LICENSE/UTILITY INCANDESCENT LIGHT



PAGE C60

NEW AND IMPROVED CAMERA SYSTEMS



PAGE D2

IMPROVED STEEL & ALUMINUM RACKS



PAGE E8-E10

STAKE POCKET SPARE TIRE CARRIER



PAGE E17

DOCUMENT HOLDER WITH CLEAR COVER



PAGE E17

FULL RADIUS POLY FENDERS



PAGE E18

ILLUMINATED LED SIGHT GUIDES



PAGE E24

STEEL MOTORCYCLE WHEEL CHOCK



PAGE E33

STEEL ELECTRIC TARP SYSTEMS



PAGE F3

ALUMINUM TENSION BOW



PAGE F5

ROCKER SWITCH KIT



PAGE F7

ALUMINUM CHAIN GUARD



PAGE F8

RETENTION BOW CATCH PLATE



PAGE F9

MANUAL SYSTEMS WITH ALUMINUM DEFLECTOR & HOUSING



PAGE G14

FORGED STAKE POCKET D-RINGS



PAGE G3

TRUCK BOXES

Buyers Products' comprehensive line of truck boxes, made in the U.S.A., set an industry standard for quality, material range, and value.



XD TRUCK BOXES

A2

NEW Smooth Aluminum Underbody with Diamond Tread Drop Door

A3

UNDERBODY TRUCK BOXES

A4

NEW Textured Matte Black Diamond Tread Aluminum

A4

NEW Steel Boxes With T-Latch and Shelf

A7

NEW Textured Matte Black Steel Boxes with Drop Door

A8

TOPSIDER TRUCK BOXES

A12

NEW Textured Matte Black And Smooth Aluminum

A12

NEW Diamond Tread Aluminum Boxes With Flip-Up Doors

A13

LO-SIDER/RAIL TRUCK BOXES

A15

NEW Textured Matte Black Diamond Tread Aluminum

A15

CROSSOVER GULL WING TRUCK BOXES

A16

NEW Textured Matte Black Diamond Tread Aluminum

A16

STORAGE CHESTS

A17

NEW Textured Matte Black Diamond Tread Aluminum

A17

SLIDE OUT TRUCK BED BOXES

A19

BACKPACK TRUCK BOXES

A20

NEW Steel Straight Side Backpacks

A21

NEW Diamond Tread Aluminum L-Pack

A22

TRAILER TONGUE BOXES

A23

STEP BOXES

A24

PARTS CABINET

A24



XD Series Truck Boxes

Buyers Toughest Line of Boxes Built for Heavy Duty Commercial Use



Steel

- 12 gauge steel box and cross-broke door
- Patent pending removable door design
- Die-cast, single-point latch system with compression sealing roller
- Automotive D-bulb seal
- Greaseable bullet hinges with 1/2" stainless steel pins
- Built-in rain gutter
- Detachable 3/16" door chains



Greaseable bullet hinges



Cross-broke door for added durability



Aluminum

- .125" thick smooth aluminum with rigid extruded box frame
- Die-cast T-handle compression latch with 3-point locking system
- Stainless steel bolt-on continuous hinge with oversized 1/4" pin
- Built-in rain gutter with automotive bulb seal
- Unobstructed box opening with no center post



XD Black Steel Underbody Heavy Duty Truck Boxes



Part No.	Height	Depth	Width	# Latches	Wt. (lb)	Cat.
1742300	18	18	24	1	80	530 (Y)
1742303	18	18	30	1	91	530 (Y)
1742305	18	18	36	1	104	530 (Y)
1742310	18	18	48	1	127	530 (Y)
1742315	18	18	60	2	175	530 (Y)
1742325	18	18	72	2	202	530 (Y)
1742335	18	18	90	2	228	530 (Y)
NEW 1742336	18	18	96	2	250	530 (Y)

XD Smooth Aluminum Underbody Truck Box with Barn-Door



Part No.	Height	Depth	Width	# Latches	Wt. (lb)	Cat.
1705405	18	18	36	1	51	530 (Y)
1705410	18	18	48	1	62	530 (Y)
1705415	18	18	60	1	73	530 (Y)
1705420	18	24	36	1	58	530 (Y)
1705425	18	24	48	1	71	530 (Y)
1705430	18	24	60	1	85	530 (Y)
1705435	24	24	36	1	67	530 (Y)
1705440	24	24	48	1	83	530 (Y)
1705445	24	24	60	1	99	530 (Y)
1705450	24	24	72	1	105	530 (Y)

XD Smooth Aluminum Underbody Truck Box with Smooth Drop Door



Part No.	Height	Depth	Width	# Latches	Wt. (lb)	Cat.
1706400	18	18	24	1	43.80	530 (Y)
NEW 1706403	18	18	30	1	50.45	530 (Y)
1706405	18	18	36	1	56.70	530 (Y)
1706410	18	18	48	1	64.45	530 (Y)
1706415	18	18	60	1	77.80	530 (Y)
1706420	18	24	36	1	56.68	530 (Y)
1706425	18	24	48	1	78.87	530 (Y)
1706430	18	24	60	1	82.70	530 (Y)

XD Smooth Aluminum Underbody Truck Box with Diamond Tread Drop Door **NEW**



Part No.	Height	Depth	Width	# Latches	Wt. (lb)	Cat.
1706500	18	18	24	1	41	530 (Y)
1706503	18	18	30	1	48	530 (Y)
NEW 1706505	18	18	36	1	56	530 (Y)
1706510	18	18	48	1	69	530 (Y)
1706515	18	18	60	1	78.8	530 (Y)

Aluminum Underbody

Diamond Tread Aluminum Underbody Truck Box

- .100" thick diamond tread aluminum
- Drop-down recessed door
- Locking die-cast T-handle compression latch(es)
- Continuous hidden hinge
- Replaceable gasket sealing system
- Aircraft-grade door cables
- Reinforced door backbone on boxes 48" and wider
- Door opening: flat surface mount (90°) or underbody mount (180°)

Natural Black Textured Matte Black

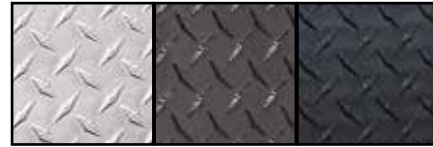

Natural



Black



Part No.	Height	Depth	Width	# Latches	Wt. (lb)	Cat.
1725150	14	12	24	1	22.5	530 (Y)
1725153	14	12	30	1	27	530 (Y)
1725160	14	16	24	1	26	530 (Y)
1725101	18	18	18	1	27	530 (Y)
1725100	18	18	24	1	30	530 (Y)
1725103	18	18	30	1	38	530 (Y)
1725105	18	18	36	1	42	530 (Y)
1725110	18	18	48	2	52	530 (Y)
1725115	18	18	60	2	70	530 (Y)
1725120	18	24	48	2	64	530 (Y)
1725130	24	24	24	1	46	530 (Y)
1725133	24	24	30	1	53	530 (Y)
1725135	24	24	36	1	59	530 (Y)
1725140	24	24	48	2	76	530 (Y)
1725145	24	24	60	2	89	530 (Y)

Part No.	Height	Depth	Width	# Latches	Wt. (lb)	Cat.
NEW 1705148	14	12	16	1	18	530 (Y)
NEW 1705149	14	12	18	1	19	530 (Y)
1705150	14	12	24	1	23	530 (Y)
1705153	14	12	30	1	26	530 (Y)
1705160	14	16	24	1	25	530 (Y)
NEW 1705102	18	18	14	1	24.6	530 (Y)
1705101	18	18	18	1	30	530 (Y)
1705100	18	18	24	1	32.5	530 (Y)
1705103	18	18	30	1	38.5	530 (Y)
1705105	18	18	36	1	43	530 (Y)
1705110	18	18	48	2	56.5	530 (Y)
1705115	18	18	60	2	66	530 (Y)
1705120	18	24	48	2	63.5	530 (Y)
1705118	20	20	36	1	46	530 (Y)
1705130	24	24	24	1	45	530 (Y)
1705133	24	24	30	1	52	530 (Y)
1705135	24	24	36	1	59.5	530 (Y)
1705140	24	24	48	2	75	530 (Y)
NEW 1705145	24	24	60	2	88.5	530 (Y)
NEW 1705147	24	24	72	2	97	530 (Y)

Textured Matte Black **NEW FINISH**



Part No.	Height	Depth	Width	# Latches	Wt. (lb)	Cat.
NEW 1715100	18	18	24	1	30	530 (Y)
NEW 1715105	18	18	36	1	42	530 (Y)
NEW 1715110	18	18	48	2	52	530 (Y)
NEW 1715115	18	18	60	2	70	530 (Y)

Diamond Tread Aluminum Underbody Truck Box with 3-point Latch

- .100" thick diamond tread aluminum
- Drop-down recessed door
- Die-cast T-handle compression latch with 3point locking system
- Continuous hidden hinge
- Replaceable gasket sealing system
- Aircraft-grade door cables
- Reinforced door backbone
- Door opening: flat surface mount (90°) or underbody mount (180°)



1735100

Part No.	Height	Depth	Width	# Latches	Wt. (lb)	Cat.
1735100	18	18	24	1	32.5	530 (Y)
1735103	18	18	30	1	38	530 (Y)
1735105	18	18	36	1	44	530 (Y)
1735130	24	24	24	1	45	530 (Y)
1735133	24	24	30	1	58	530 (Y)
1735135	24	24	36	1	63	530 (Y)

Diamond Tread Aluminum Underbody Truck Box with Drawer

- .100" thick diamond tread aluminum
- Drop-down recessed door
- Locking die-cast T-handle compression latch
- Continuous hidden hinge
- Replaceable gasket sealing system
- Door opening: flat surface mount (90°) or underbody mount (180°)
- Reinforced door backbone
- Aircraft-grade door cables
- Drawer comes with adjustable dividers and 100lb rated slides



1712205

Part No.	Height	Depth	Width	# Latches	Wt. (lb)	Cat.
1712200	20	18	24	2	50	530 (Y)
1712205	20	18	36	2	66	530 (Y)
1712210	20	18	48	2	85	530 (Y)

Diamond Tread Aluminum Underbody Truck Box with Barn-Door

- .100" thick diamond tread
- Side-hinged doors with optional right/left locking door
- Die-cast T-handle compression latch with 3-point locking system
- Aluminum continuous hinge with oversize 1/4" pin
- D-bulb door seal
- Can mount on flat surface
- Unobstructed box opening with no center post



1705201

1705205

Part No.	Height	Depth	Width	# Latches	Wt. (lb)	Cat.
1705201	18	18	18	1	27	530 (Y)
1705200	18	18	24	1	36	530 (Y)
1705203	18	18	30	1	42	530 (Y)
1705205	18	18	36	1, 2 Doors	49	530 (Y)
1705210	18	18	48	1, 2 Doors	63	530 (Y)
1705215	18	18	60	1, 2 Doors	77	530 (Y)
1702235	24	24	36	1, 2 Doors	71	530 (Y)
1702240	24	24	48	1, 2 Doors	76	530 (Y)
1702250	24	24	60	1, 2 Doors	87	530 (Y)

Smooth Aluminum Underbody Truck Box with Barn-Door

- .125" thick smooth aluminum
- Side-hinged doors with optional right/left locking door
- Die-cast T-handle compression latch with 3-point locking system
- Aluminum continuous hinge with oversize 1/4" pin
- D-bulb door seal
- Can mount on flat surface
- Unobstructed box opening with no center post



1705305

Part No.	Height	Depth	Width	# Latches	Wt. (lb)	Cat.
NEW 1705303	18	18	30	1	42	530 (Y)
1705305	18	18	36	1	49	530 (Y)
1705310	18	18	48	1	63	530 (Y)
1705315	18	18	60	1	77	530 (Y)
1705333	24	24	30	1	69	530 (Y)
1705335	24	24	36	1	75	530 (Y)
1705340	24	24	48	1	87	530 (Y)
1705345	24	24	60	1	99	530 (Y)
1705350	24	24	72	1	98	530 (Y)

Steel Underbody

Steel Underbody Truck Boxes with T-Latch

- 14 gauge steel box with 12 gauge steel door
- Drop-down recessed door
- Locking stainless steel T-handle latches
- Continuous hidden hinge
- Replaceable gasket sealing system
- Aircraft-grade door cables
- Reinforced door backbone on boxes 48" and wider
- Door opening: flat surface mount (90°) or underbody mount (180°)
- **Note:** *66" boxes are constructed of 12 gauge steel



Black



White



Part No.	Height	Depth	Width	# Latches	Wt. (lb)	Cat.
1703349	14	12	18	1	37	530 (Y)
1703350	14	12	24	1	40	530 (Y)
NEW 1703353	14	12	30	1	49	530 (Y)
1703300	14	16	24	1	56	530 (Y)
1703303	14	16	30	1	65	530 (Y)
1703305	14	16	36	1	74	530 (Y)
1703310	15	10	15	1	28	530 (Y)
1703312	15	10	24	1	39	530 (Y)
1703320	15	13	15	1	32	530 (Y)
NEW 1703322	15	13	24	1	45	530 (Y)
1703324	15	13	30	1	53	530 (Y)
1703326	15	13	36	1	61	530 (Y)
1703328	15	13	48	2	83	530 (Y)
1703330	16	14	18	1	50	530 (Y)
1702295	18	18	18	1	47	530 (Y)
1702300	18	18	24	1	67	530 (Y)
1702303	18	18	30	1	80	530 (Y)
1702305	18	18	36	1	92	530 (Y)
1702310	18	18	48	2	118	530 (Y)
1702315	18	18	60	2	143	530 (Y)
1702317*	18	18	66	2	186	530 (Y)
1702325	18	18	72	2, 2 Doors	156	530 (Y)
1708310	18	24	48	2	133	530 (Y)
1704300	24	24	24	1	87	530 (Y)
1704303	24	24	30	1	100	530 (Y)
1704305	24	24	36	1	116	530 (Y)
1704310	24	24	48	2	145	530 (Y)
1704315	24	24	60	2	175	530 (Y)

Part No.	Height	Depth	Width	# Latches	Wt. (lb)	Cat.
1703400	14	16	24	1	56	530 (Y)
1703403	14	16	30	1	65	530 (Y)
1703405	14	16	36	1	71	530 (Y)
1702400	18	18	24	1	67	530 (Y)
1702403	18	18	30	1	80	530 (Y)
1702405	18	18	36	1	92	530 (Y)
1702410	18	18	48	2	118	530 (Y)
1702415	18	18	60	2	143	530 (Y)
1702417*	18	18	66	2	186	530 (Y)
1708410	18	24	48	2	133	530 (Y)
1704400	24	24	24	1	87	530 (Y)
1704403	24	24	30	1	100	530 (Y)
1704405	24	24	36	1	116	530 (Y)
1704410	24	24	48	2	145	530 (Y)
1704415	24	24	60	2	175	530 (Y)

Primed



Part No.	Height	Depth	Width	# Latches	Wt. (lb)	Cat.
1703900	14	16	24	1	56	530 (Y)
1702900	18	18	24	1	67	530 (Y)
1702905	18	18	36	1	92	530 (Y)
1702910	18	18	48	2	118	530 (Y)

Steel Underbody Truck Boxes with Paddle Latch

- 14 gauge steel box with 12 gauge steel door
- Drop-down recessed door
- Locking stainless steel paddle latch
- Continuous hidden hinge
- Replaceable gasket sealing system
- Aircraft-grade door cables
- Reinforced door backbone on boxes 48" and wider
- Door opening: flat surface mount (90°) or underbody mount (180°)
- **Note:** 66" boxes are constructed of 12 gauge steel



Black



White



Part No.	Height	Depth	Width	# Latches	Wt. (lb)	Cat.
1703100	14	16	24	1	56	530 (Y)
1703103	14	16	30	1	65	530 (Y)
1703150	14	12	24	1	48	530 (Y)
1702100	18	18	24	1	67	530 (Y)
1702103	18	18	30	1	80	530 (Y)
1702105	18	18	36	1	92	530 (Y)
1702110	18	18	48	2	118	530 (Y)
1702115	18	18	60	2	143	530 (Y)

Part No.	Height	Depth	Width	# Latches	Wt. (lb)	Cat.
1703203	14	16	30	1	65	530 (Y)
1703205	14	16	36	1	74	530 (Y)
1702200	18	18	24	1	67	530 (Y)
1702203	18	18	30	1	80	530 (Y)
1702205	18	18	36	1	92	530 (Y)
1702210	18	18	48	2	118	530 (Y)
1702215	18	18	60	2	143	530 (Y)

Steel Underbody Truck Boxes with T-Latch and Shelf **NEW**

- 14 gauge steel box with 4 gauge steel shelf welded at mid height, 12-3/4" deep with 1" front lip and 12 gauge steel door
- Drop-down recessed door
- Locking stainless steel T-handle latches
- Continuous hidden hinge
- Replaceable gasket sealing system
- Aircraft-grade door cables
- Door opening: flat surface mount (90°) or underbody mount (180°)



Part No.	Color	Height	Depth	Width	# Latches	Wt. (lb)	Cat.
NEW 1703304	Black	14	16	30	1	72	530 (Y)
NEW 1703404	White	14	16	30	1	72	530 (Y)



Steel Underbody Drop Door Truck Box with 3-Point Latch

- 14 gauge steel box with 12 gauge steel door
- Drop-down recessed door
- Die-cast T-handle compression latch with 3-point locking system
- Continuous hidden hinge
- Replaceable gasket sealing system
- Aircraft-grade door cables
- Reinforced door backbone
- Door opening: flat surface mount (90°) or underbody mount (180°)

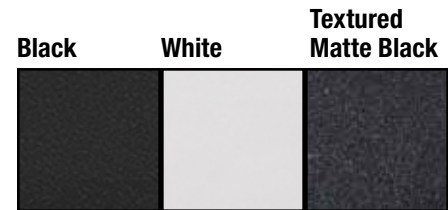

Textured Matte Black **NEW FINISH**



1732505



1732500

Part No.	Height	Depth	Width	# Latches	Wt. (lb)	Cat.
1732500	18	18	24	1	59	530 (Y)
1732503	18	18	30	1	70	530 (Y)
1732505	18	18	36	1	83	530 (Y)
NEW 1732510	18	18	48	1	118	530 (Y)
1734500	24	24	24	1	84	530 (Y)
1734503	24	24	30	1	95	530 (Y)
1734505	24	24	36	1	110	530 (Y)

Black



1732305

White



1732405

Part No.	Height	Depth	Width	# Latches	Wt. (lb)	Cat.
1732300	18	18	24	1	59	530 (Y)
1732303	18	18	30	1	70	530 (Y)
1732305	18	18	36	1	83	530 (Y)
NEW 1732310	18	18	48	1	118	530 (Y)
1734300	24	24	24	1	84	530 (Y)
1734303	24	24	30	1	95	530 (Y)
1734305	24	24	36	1	110	530 (Y)

Part No.	Height	Depth	Width	# Latches	Wt. (lb)	Cat.
1732400	18	18	24	1	59	530 (Y)
1732403	18	18	30	1	70	530 (Y)
1732405	18	18	36	1	83	530 (Y)
1734400	24	24	24	1	84	530 (Y)
1734403	24	24	30	1	95	530 (Y)
1734405	24	24	36	1	110	530 (Y)

Underbody Truck Boxes with Polished Stainless Steel Door

- 16 gauge steel or stainless box with 12 gauge steel door or polished 12 gauge stainless steel door
- Drop-down recessed door
- Locking die-cast T-handle compression latch
- Continuous hidden hinge
- Replaceable gasket sealing system
- Aircraft-grade door cables
- Bolted-on door backbone on boxes 48" and wider
- Door opening: flat surface mount (90°) or underbody mount (180°)

Black / Polished Stainless Steel



1702725

Part No.	Height	Depth	Width	# Latches	Wt. (lb)	Cat.
1703700	14	16	24	1	55	530 (Y)
1703703	14	16	30	1	64	530 (Y)
1703705	14	16	36	1	71	530 (Y)
1702700	18	18	24	1	72	530 (Y)
1702703	18	18	30	1	81	530 (Y)
1702705	18	18	36	1	101	530 (Y)
1702710	18	18	48	2	110	530 (Y)
1702715	18	18	60	2	132	530 (Y)
1702725	18	18	72	2, 2 doors	156	530 (Y)
1704705	24	24	36	1	132	530 (Y)
1704710	24	24	48	2	169	530 (Y)
1704715	24	24	60	2	227	530 (Y)

Black Stainless

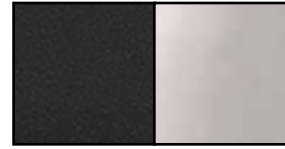

Stainless / Polished Stainless Steel



1702600

Part No.	Height	Depth	Width	# Latches	Wt. (lb)	Cat.
1702595	18	18	18	1	51.5	530 (Y)
1702600	18	18	24	1	61.5	530 (Y)
1702603	18	18	30	1	81	530 (Y)
1702605	18	18	36	1	101	530 (Y)
1702610	18	18	48	2	110	530 (Y)
NEW 1704600	24	24	24	1	86	530 (Y)
1704605	21	24	36	1	114	530 (Y)

Mirror Finish Stainless Steel Underbody Truck Box

- 16 gauge high polish steel box and door
- Drop-down door
- Locking die-cast T-handle compression latch
- Continuous hidden hinge
- Gasket sealing system
- Replaceable door cables
- Built-in rain gutter with automotive bulb seal



1702650

Part No.	Height	Depth	Width	# Latches	Wt. (lb)	Cat.
1702650	18	18	24	1	48	530 (N)
1702653	18	18	30	1	57	530 (N)
1702655	18	18	36	1	65	530 (N)
1702660	18	18	48	2	80	530 (N)

Specialty Underbody

Black Steel Underbody Truck Box with Aluminum Door

- 14 gauge steel box with 12 gauge steel door
- Drop-down recessed door
- Locking stainless steel paddle latch
- Continuous hidden hinge
- Replaceable gasket sealing system
- Aircraft-grade door cables
- Door opening: flat surface mount (90°) or underbody mount (180°)
- Reinforced door backbone on boxes 48" and wider
- **Note:** 66" boxes are constructed of 12 gauge steel



Part No.	Height	Depth	Width	# Latches	Wt. (lb)	Cat.
1702500	18	18	24	1	61	530 (Y)
1702503	18	18	30	1	72	530 (Y)
1702505	18	18	36	1	82	530 (Y)
1702510	18	18	48	2	104	530 (Y)

Black Steel Underbody Truck Box with Slanted Back

- 14 gauge steel box with 12 gauge steel door with black powder coat finish
- Drop-down recessed door
- Locking stainless steel T-handle
- Continuous hidden hinge
- Replaceable gasket sealing system
- Aircraft-grade door cables
- Angled top allows room for fuel fill hoses on single rear wheel flat beds
- Door opening: flat surface mount (90°) or underbody mount (180°)



Profile

1703351

Part No.	Height	Depth	Width	# Latches	Wt. (lb)	Cat.
1703351	14	12	18	1	40	530 (Y)
1703352	14	12	24	1	47	530 (Y)

Polymer Underbody Truck Box

- Constructed of high-density polyethylene
- Drop down door
- Stainless steel T-handle compression latch with 3-point locking system
- Stainless steel hinge pin
- Replaceable gasket sealing system
- Aircraft-grade door cables
- Molded double-wall door design



1717110

Part No.	Height	Depth	Width	# Latches	Wt. (lb)	Cat.
1717100	18	18	24	1	24	530 (Y)
1717105	18	18	36	1	31	530 (Y)
1717110	18	18	48	1	42	530 (Y)

Stainless Steel Mounting Brackets



1701031

- Stainless steel construction
- Universal hole pattern for quick and easy mounting
- Welded braces
- Sold in boxed pairs
- Hardware not included

Part No.	Description	Dim	Wt. (lb)	Cat.
1701031	Welded Brackets	18"x18"	19	531 (Y)
1701041	Welded Brackets	18"x24"	22	531 (Y)

Aluminum Mounting Brackets



1701030

- Aluminum construction
- 1/4" formed aluminum angles
- Welded braces
- Sold in boxed pairs

Part No.	Description	Dim	Wt. (lb)	Cat.
1701030	Welded Brackets	18"x18"	7.5	531 (Y)
1701040	Welded Brackets	24"x24"	10	531 (Y)

Truck Box Door Lanyard

- 3/32" PVC coated galvanized steel wire lanyard with two swagged eyelets
- Custom sizes available by quote



3003081

Part No.	Dimensions	Wt. (lb)	Cat.
3027064	8.75" C-C	0.04	591 (N)
3027065	9.63" C-C	0.04	591 (N)
3003480	12.65" C-C	0.06	591 (N)
3004556	15.56" C-C	0.06	591 (N)
3003081	17.15" C-C	0.07	591 (N)
3024237	18.50" C-C	0.07	591 (N)
3024713	25.75" C-C	0.08	591 (N)
3024238	27.10" C-C	0.08	591 (N)

Steel Mounting Brackets



1701005

- Constructed of formed 3" steel C-channel, black powder coated for corrosion resistance
- Universal hole pattern for quick and easy mounting,
- Available with welded braces or bolt-on braces
- Available in heavy-duty structural steel
- Sold in boxed pairs
- Hardware not included

Part No.	Description	Dim	Wt. (lb)	Cat.
1701006	Formed Welded Brackets	18"x18"	16	531 (Y)
1701011	Formed Welded Brackets	18"x24"	19	531 (Y)
1701006B	Formed Bolted Brackets	18"x18"	16	531 (Y)
1701011B	Formed Bolted Brackets	18"x24"	19	531 (Y)
1701016	Formed Welded Brackets	24"x24"	22	531 (Y)
1701005	Structural Welded Brackets	18"x18"	24	531 (Y)
1701010	Structural Welded Brackets	18"x24"	27	531 (Y)
1701005B	Structural Bolted Brackets	18"x18"	24	531 (Y)
1701010B	Structural Bolted Brackets	18"x24"	27	531 (Y)
1701015	Structural Welded Brackets	24"x24"	32	531 (Y)
NEW 1701012	Structural Welded Brackets	27"x18"	47	531 (Y)

Mounting Brackets for Polymer Truck Boxes



1701000

- Constructed of heavy-duty 2" C-channel A-36 steel
- Black powder coated
- Channel fits inside toolbox ribs
- Pre-drilled 7/16" mounting holes (nuts/bolts not included)
- Sold in boxed pairs

Part No.	Description	Dim	Wt. (lb)	Cat.
1701000	Brackets for 24" and 36" Poly	15"x14"	15.5	530 (Y)
1701001	Brackets, for 48" Poly	15"x14"	11	530 (Y)

Dry-Mat Tile



- 3/4" thick, tough automotive grade recycled plastic
- Relieves physical stress on the job
- Provides fast evaporation while protecting the surface below
- Maintains original shape and color
- Fast, easy installation

Part No.	Description	Dim	Wt. (lbs.)	Cat.
DM1212B	Tile	12" x 12"	1.42	880 (N)
DM0212BF	Female Edge	2" x 12"	0.33	880 (N)
DM0212BM	Male Edge	2" x 12"	0.35	880 (N)

Topsiders

Diamond Tread Aluminum Topsider Truck Box

- .100" thick diamond tread aluminum
- Locking die-cast T-handle compression latch
- Replaceable gasket sealing system
- Aircraft-grade door cables
- Includes J-hooks for no-drill mounting and protective side rail pads
- Door opening: flat surface mount (90°)



Textured Matte Black *NEW FINISH*



1722568

Natural Smooth *NEW FINISH*



Part No.	Height	Depth	Width	# Latches	Wt. (lb)	Cat.
1722551	16	13	72	1	78	530 (Y)
1722568	18	16	96	2	103	530 (Y)

Part No.	Height	Depth	Width	# Latches	Wt. (lb)	Cat.
1751651	16	13	72	1	78	530 (Y)
1751656	16	13	88	1	89	530 (Y)
1751661	16	13	96	2	92	530 (Y)
1751663	18	16	72	1	93	530 (Y)
1751664	18	16	88	1	96	530 (Y)
1751665	18	16	90	1	99	530 (Y)
1751668	18	16	96	2	103	530 (Y)

Natural



1701551



1701561

Black



1721551



1721561

Part No.	Height	Depth	Width	# Latches	Wt. (lb)	Cat.
1701551	16	13	72	1	78	530 (Y)
1701556	16	13	88	1	89	530 (Y)
1701561	16	13	96	2	92	530 (Y)
1701565	18	16	90	1	99	530 (Y)
1701568	18	16	96	2	103	530 (Y)

Part No.	Height	Depth	Width	# Latches	Wt. (lb)	Cat.
1721551	16	13	72	1	78	530 (Y)
1721556	16	13	88	1	89	530 (Y)
1721561	16	13	96	2	92	530 (Y)
1721565	18	16	90	1	99	530 (Y)
1721568	18	16	96	2	103	530 (Y)

Flip-Up Door Diamond Tread Aluminum Topsider Truck Box **NEW**

- Gas shock lifts and holds door open at 110°
- .100" thick diamond tread aluminum
- Die-cast T-handle compression latches with roller cam and key lock
- Full length continuous hidden hinge
- Recessed door design with large 13" tall opening
- Integrated above door rain gutter
- Reinforced door backbone
- 1/2" automotive d-bulb seal



Part No.	Height	Depth	Width	# Latches	Wt. (lb)	Cat.
NEW 1701768	18	16	96	2	103	530 (Y)

Steel Topsider Truck Box

- 16 gauge steel box with 14 gauge steel doors
- Drop-down recessed doors
- Locking stainless steel t-handles
- Continuous hidden hinge
- Replaceable gasket sealing system
- Aircraft-grade door cables
- Optional quick-mount trays
- Includes J-hooks for no-drill mounting and protective side rail pads
- Door opening: flat surface mount (90°)



Black



Part No.	Height	Depth	Width	# Latches	Wt. (lb)	Cat.
1702940	16	13	72	2	115	530 (Y)
1702950	16	13	88	2	120	530 (Y)
1702960	16	13	96	2	128	530 (Y)
1702940TRAY	2.25/4	10.75	35	-	11	530 (Y)
1702950TRAY	2.25/4	10.75	43	-	14	530 (Y)
1702960TRAY	2.25/4	10.75	47	-	15	530 (Y)

White



Part No.	Height	Depth	Width	# Latches	Wt. (lb)	Cat.
1702840	16	13	72	2	115	530 (Y)
1702850	16	13	88	2	120	530 (Y)
1702860	16	13	96	2	128	530 (Y)
1702840TRAY	2.25/4	10.75	35	-	11	530 (Y)
1702850TRAY	2.25/4	10.75	43	-	14	530 (Y)
1702860TRAY	2.25/4	10.75	47	-	15	530 (Y)

See page C14 for our large selection of Strip Lights!



shown installed inside a truck box

Contractor-Style Topsider

Diamond Tread Aluminum Contractor Truck Box

- .056" thick diamond tread aluminum with slanted double level box
- Comes with 2 doors*: top flip-up door (with gas shocks) and bottom drop door
- Locking stainless steel T-handle latch
- Replaceable gasket sealing system
- Aircraft-grade door cables
- Includes mounting hardware

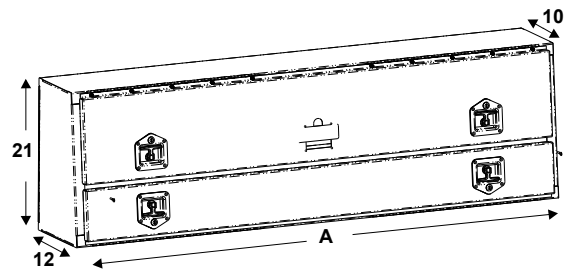
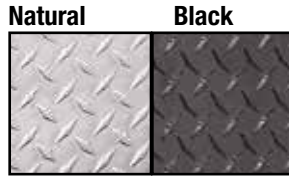

Natural



Black



Part No.	Top Doors	Bottom Doors	Height	Depth	Width (A)	Wt. (lb)	Cat.
1705640	1	1	21	12 / 10	72	68.5	530 (Y)
1705650	1	1	21	12 / 10	88	83.5	530 (Y)
1705660	1	1	21	12 / 10	96	88.5	530 (Y)

Part No.	Top Doors	Bottom Doors	Height	Depth	Width (A)	Wt. (lb)	Cat.
1725640	1	1	21	12 / 10	72	68.5	530 (Y)
1725650	1	1	21	12 / 10	88	83.5	530 (Y)
1725660	1	1	21	12 / 10	96	88.5	530 (Y)

Diamond Tread Aluminum Contractor Truck Box with Lower Drawers

- .056" thick diamond tread aluminum
- Locking stainless steel T-handle latch
- Replaceable gasket sealing system
- Aircraft-grade door cables
- Drawer comes with adjustable dividers and 100lb rated slides
- Mounting legs and hardware included
- Door opening: flat surface mount (90°)

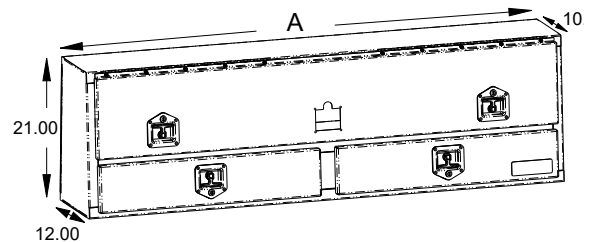
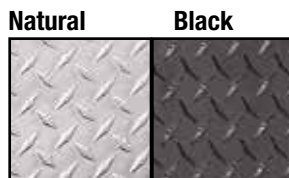

Natural



Black



Part No.	Top Doors	Bottom Drawers	Height	Depth	Width (A)	Wt. (lb)	Cat.
1705641	1	2	21	13.5/11.5	72	58	530 (Y)
1705651	1	2	21	13.5/11.5	88	91	530 (Y)

Part No.	Top Doors	Bottom Drawers	Height	Depth	Width (A)	Wt. (lb)	Cat.
1725641	1	2	21	13.5/11.5	72	58	530 (Y)
1725651	1	2	21	13.5/11.5	88	91	530 (Y)

Diamond Tread Aluminum Lo-Sider Truck Box

- .056" thick diamond tread
- Door assisting gas shocks
- Locking stainless steel paddle latch
- Includes tray and dividers
- Mounting hardware included
- Fits full size pickups with 6-1/2' and 8' beds

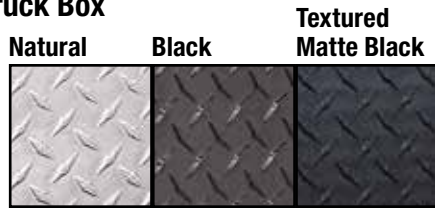

Natural

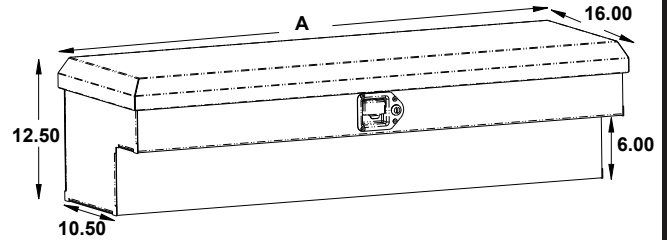

Part No.	Application	Height	Depth	Width (A)	Cubic ft.	Wt. (lb)	Cat.
1711010	Mounts along bedrail of pickups	12.5	10.5 16	47	3.4	23	530 (Y)
1711020	Mounts along bedrail of pickups	12.5	10.5 16	56	4.0	47	530 (Y)
1711025	Mounts along bedrail of pickups	12.5	10.5 16	70	5.2	52	530 (Y)
1711030	Mounts along bedrail of pickups	12.5	10.5 16	87	6.3	63	530 (Y)

Black



Part No.	Application	Height	Depth	Width (A)	Cubic ft.	Wt. (lb)	Cat.
1721010	Mounts along bedrail of pickups	12.5	10.5 16	47	3.4	23	530 (Y)
1721020	Mounts along bedrail of pickups	12.5	10.5 16	56	4.0	47	530 (Y)
1721025	Mounts along bedrail of pickups	12.5	10.5 16	70	5.2	52	530 (Y)
1721030	Mounts along bedrail of pickups	12.5	10.5 16	87	6.3	63	530 (Y)

Textured Matte Black **NEW FINISH**



Part No.	Application	Height	Depth	Width (A)	Cubic ft.	Wt. (lb)	Cat.
NEW 1731020	Mounts along bedrail of pickups	12.5	10.5 16	56	4.0	47	530 (Y)

Diamond Tread Aluminum Wheel Well Truck Box

- .100" thick aluminum diamond tread
- Lid features gas shock and one-touch stainless steel push button rotary locking mechanism
- Low profile over-the-wheel mounting offers convenient storage while maximizing pickup truck bed space
- Fits most pickups
- May also be mounted in front of wheel wells on full-size long bed pickups

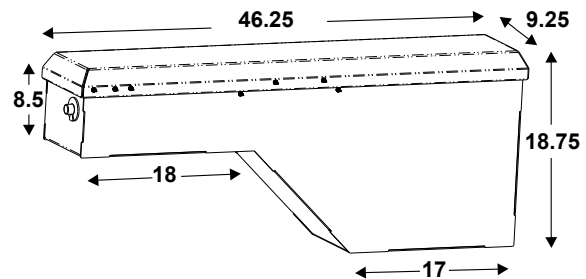

Part No.	Description	Height	Depth	Width	Wt. (lb)	Cat.
1711205	Drivers' Side Rear/Passengers' Side Front	18.75 / 8.5	9.25	46.25 / 18 / 17	26	530 (Y)
1711206	Passengers' Side Rear/Drivers' Side Front	18.75 / 8.5	9.25	46.25 / 18 / 17	26	530 (Y)

Crossover

Diamond Tread Aluminum Gull Wing Truck Box

- .100" thick diamond tread
- Double-sided lids with gas shocks
- Stainless steel one-touch push button locks
- Reinforced rib design
- Includes tray and dividers
- Suspends from pickup side rails with included J-Hooks
- Fits full size pickups with 6-1/2' and 8' beds

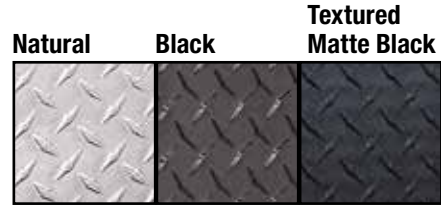

Textured Matte Black *NEW FINISH*

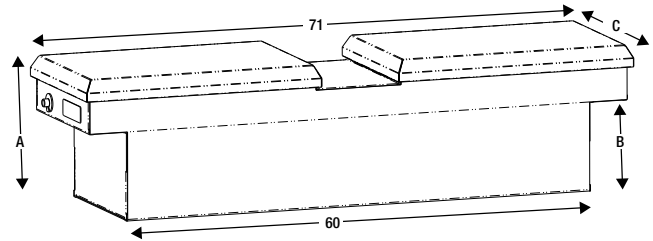

Part No.	Height (A / B)	Depth (C)	Width	Cubic ft.	Wt. (lb)	Cat.
NEW 1722305	18 / 11	20	71	11.1	67	530 (Y)

Natural



1710305

Part No.	Height (A / B)	Depth (C)	Width	Cubic ft.	Wt. (lb)	Cat.
1710305	18 / 11	20	71 / 60	11.1	67	530 (Y)
1710308	23 / 16	20	71 / 60	14.2	73	530 (Y)
1710315	18 / 11	27	71 / 60	15.1	81	530 (Y)
1710318*	23 / 16	27	71 / 60	19.1	85	530 (Y)

*Works in beds with slants

Black



1720305

Part No.	Height (A / B)	Depth (C)	Width	Cubic ft.	Wt. (lb)	Cat.
1720305	18 / 11	20	71 / 60	11.1	67	530 (Y)
1720308	23 / 16	20	71 / 60	14.2	73	530 (Y)
1720315	18 / 11	27	71 / 60	15.1	81	530 (Y)
1720318*	23 / 16	27	71 / 60	19.1	85	530 (Y)

*Works in beds with slants

Diamond Tread Aluminum Crossover Truck Box

- .100" thick diamond tread
- Wide opening lid with two gas shocks
- Stainless steel one-touch push button locks
- Reinforced rib design
- Includes tray and dividers
- Suspends from pickup side rails with included mounting hardware
- Fits full size pickups with 6-1/2' and 8' beds

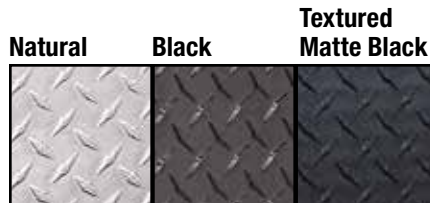

Textured Matte Black **NEW FINISH**

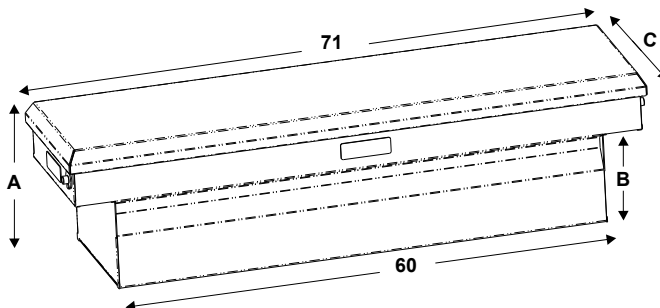

Part No.	Height (A / B)	Depth (C)	Width	Cubic ft.	Wt. (lb)	Cat.
NEW 1739305	18 / 11	20	71 / 60	11.1	75	530 (Y)

Natural



Black



Part No.	Height (A / B)	Depth (C)	Width	Cubic ft.	Wt. (lb)	Cat.
1709305	18 / 11	20	71 / 60	11.1	75	530 (Y)
1709308	23 / 16	20	71 / 60	14.2	77	530 (Y)
1709315	18 / 11	27	71 / 60	15.1	89	530 (Y)
1709318*	23 / 16	27	71 / 60	19.1	91	530 (Y)

*Works in beds with slants

Part No.	Height (A / B)	Depth (C)	Width	Cubic ft.	Wt. (lb)	Cat.
1729305	18 / 11	20	71 / 60	11.1	75	530 (Y)
1729308	23 / 16	20	71 / 60	14.2	77	530 (Y)
1729315	18 / 11	27	71 / 60	15.1	89	530 (Y)
1729318*	23 / 16	27	71 / 60	19.1	91	530 (Y)

*Works in beds with slants

Black Poly All-Purpose Chest

- Constructed of high-density polyethylene
- Stainless steel hasp and hinge
- Designed for a secure fit when mounting to your trailer frame

Part No.	# Hasps	Height	Depth	Width	Cubic ft.	Wt. (lb)	Cat.
1712230	1	13.5	15 / 9.25	32 / 29.5	2.6	16	530 (Y)
1712240	2	17.25	19 / 13.25	44 / 41.25	6.3	28	530 (Y)
1712250	1	22.5	19.5 / 18.75	51 / 47	8.4	34	530 (Y)
1712255	2	26	23 / 21	51 / 47.25	15.8	46	530 (Y)
1712260	2	23	25 / 19	77 / 73	18.8	52	530 (Y)



1712230

All-Purpose Chests

Diamond Tread Aluminum All-Purpose Chest with Angled Base

- .056" thick diamond tread
- Door assisting gas shocks
- Stainless steel one-touch push button locks
- Angled body for use with fifth wheel or gooseneck trailer application
- Includes tray and dividers
- Offset lid allows for 90° opening when placed against truck bed

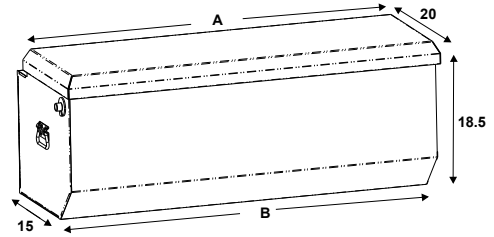

Natural



1712030

Textured Matte Black **NEW FINISH**



1722010

Part No.	Height	Depth	Width (A / B)	Cubic ft.	Wt. (lb)	Cat.
1712010	18.5	20/15	47/47	10	52.5	530 (Y)
1712020	18.5	20/15	55/54	12	55	530 (Y)
1712030	19	20/16	60/52	12.5	60	530 (Y)
1712035	19	27/27	60/52	18	74	530 (Y)

Part No.	Height	Depth	Width (A / B)	Cubic ft.	Wt. (lb)	Cat.
NEW 1722010	18.5	20/15	47/47	10	52.5	530 (Y)

Diamond Tread Aluminum All-Purpose Jumbo Chest

- .100" thick diamond tread
- Door assisting gas shocks
- Locking stainless steel paddle latch
- Aluminum hinge
- Side handles for easy lifting



1712110

Part No.	Height	Depth	Width	Cubic ft.	Wt. (lb)	Cat.
1712110	24	24/22	49	15	73.5	530 (Y)
1712120	30	30/28	49	24	92	530 (Y)

Heavy Duty Poly Storage Bins

- Durable, corrosion free construction
- Double panel, sloped lid with integral hasp
- Stainless steel hinge
- Hand holds for ease of carrying
- Fork lift slots
- Store grain, salt, etc. in a dry area
- Stackable
- **9031105** ships UPS



Part No.	Height	Depth	Width	Wt. (lb)	Cat.
9031100	30	24	36	28	903-1 (N)
9031105	20	24	36	21	903-1 (N)
9031110	Material Scoop			2.47	903-1 (N)

Slide Out Truck Bed Box

- Industry-leading weight capacity up to 500 lbs for drawers and 800 lbs for top load (evenly distributed)
- Heavy duty reinforced aluminum box and drawer construction
- Drawer automatically detents into a locked position every 8 inches for controlled motion and convenience
- Releases easily with push button (one-hand operated)
- Industry-leading customization with movable dividers to accommodate tools and hardware
- Full door gasket and rain gutter for four-sided protection against the elements
- Mounting hardware included along with predrilled mounting holes
- Comes complete with dividers, additional divider kits also available.



Natural Aluminum Part No.	Black Aluminum Part No.	White Aluminum Part No.	Height	Depth	Width	Wt. (lb)	Cat.
1718010	1718310	1718410	9	48	20	78	530 (Y)
1718015	1718315	1718415	9	48	40	130	530 (Y)
1718020	1718320	1718420	12	24	40	90	530 (Y)
1718025	1718325	1718425	12	48	20	92	530 (Y)
1718030	1718330	1718430	12	48	40	150	530 (Y)

Divider Kit for Bed Boxes

Part No.	Description	Cat.
3036255	Works with (1718015, 1718315, 1718415)	530 (Y)
3036256	Works with (1718020, 1718320, 1718420)	530 (Y)
3036257	Works with (1718030, 1718330, 1718430)	530 (Y)

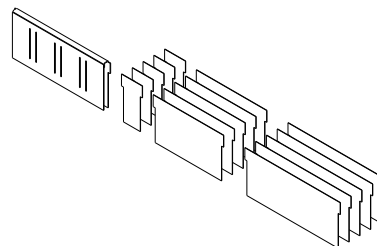

Steel Backpacks

Steel Backpack Truck Box

- 14 gauge steel box with 12 gauge steel doors
- Gas spring door holders
- Locking stainless steel T-handle latches
- Stainless steel continuous hidden hinge
- Built-in rain gutter with automotive bulb seal
- Two folding, passenger side J-hooks
- Built-in chassis mounting rail
- Two fixed shelves
- Optional steel bolt-on underbody box (see Backpack accessories or appropriate underbody category for more information)
- **Flat Floor:** Cab-over tucks
- **Offset Floor:** Conventional Cabs

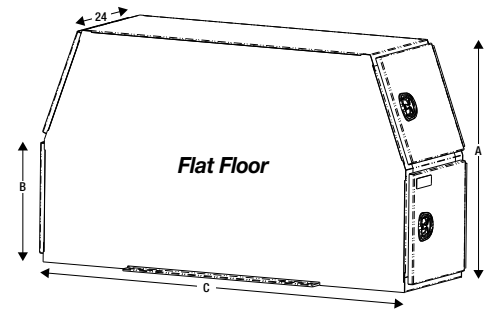
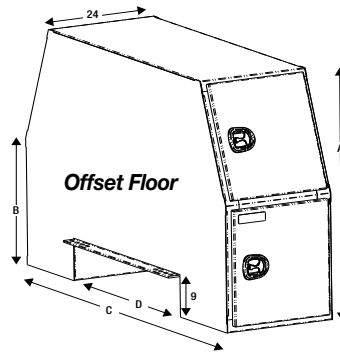

Black

Part No.	Floor (E)	Total Height (A / B)	Depth	Width (C / D)	Wt. (lb)	Cat.
BP855524B	Offset Floor (9.10")	55 / 28	24	85 / 42	536	592 (Y)
BP824624B	Flat Floor, No Offset	46 / 24	24	81	454	592 (Y)
BP855924B	Flat Floor, No Offset	59 / 30	24	85	534	592 (Y)
1703300*	Black Steel Underbody Toolbox	14	16	24	46	530 (Y)

White

Part No.	Floor (E)	Total Height (A / B)	Depth	Width (C / D)	Wt. (lb)	Cat.
BP855524W	Offset Floor (9.10")	55 / 28	24	85 / 42	536	592 (Y)
BP824624W	Flat Floor, No Offset	46 / 24	24	81	454	592 (Y)
BP855924W	Flat Floor, No Offset	59 / 30	24	85	534	592 (Y)
1703400*	White Steel Underbody Toolbox	14	16	24	46	530 (Y)

Primed

Part No.	Floor (E)	Total Height (A / B)	Depth	Width (C / D)	Wt. (lb)	Cat.
BP855524P	Offset Floor (9.10")	55 / 28	24	85 / 42	536	592 (Y)
BP855924P	Flat Floor, No Offset	59 / 30	24	85	534	592 (Y)
1703900*	Primed Steel Underbody Toolbox	14	16	24	46	530 (Y)

*See steel underbodies for more information and images

Steel Straight Side Backpack Truck Box **NEW**

- Flat base above floor, ideal for cab-over trucks
- Provides clearance for frame mounted battery boxes and tanks
- Two stationary shelves plus floor storage
- Two doors with locking T-handle latches & gas spring door holders
- Automotive style, rubber D-bulb sealed doors
- Stainless steel, 1/8" pin continuous door hinges
- Built-in frame mounting rails save time on installation and eliminate interior holes

Available Options:

- Two full length stationary shelves
- Die-cast T-handle latches

Black



White



Primed



Black

Part No.	Latch	Shelves	Total Height	Depth	Width	Wt. (lb)	Cat.
NEW BP964824B	Stainless T-handle	(2) 75" length	48	24	96	700	592 (Y)
3036510	Die-cast T-handle	(2) full length	48	24	96	700	592 (Y)

White

Part No.	Latch	Shelves	Total Height	Depth	Width	Wt. (lb)	Cat.
NEW BP964824W	Stainless T-handle	(2) 75" length	48	24	96	700	592 (Y)
3036511	Die-cast T-handle	(2) full length	48	24	96	700	592 (Y)

Primed

Part No.	Latch	Shelves	Total Height	Depth	Width	Wt. (lb)	Cat.
NEW BP964824P	Stainless T-handle	(2) 3/75" length	48	24	96	700	592 (Y)

J-Hook Hanger



- Universal J-hook hangers
- Bolt-on or weld-on
- Folding zinc plated J-hooks swing flush with compartment walls when not in use

Part No.	Description	Wt. (lb)	Cat.
3009122	Double J-Hook with Steel Mounting Angle	0.85	530-1 (N)
3009938	Triple J-Hook with Aluminum Mounting Angle	2.16	530-1 (N)

Aluminum Backpacks

Diamond Tread Aluminum Backpack Truck Box



- .100" thick aluminum diamond tread
- Gas spring door holders
- Locking die-cast T-handle compression latches
- Stainless steel continuous hinge
- Built-in rain gutter with automotive bulb seal
- Two folding J-hooks on passenger side of box
- Spring cushioned mounting kit included
- Built-in chassis mounting rail
- Two fixed shelves
- Optional aluminum bolt-on underbody box (BP141624)
- **Flat Floor:** Cab-over tucks
- **Offset Floor:** Conventional Cabs

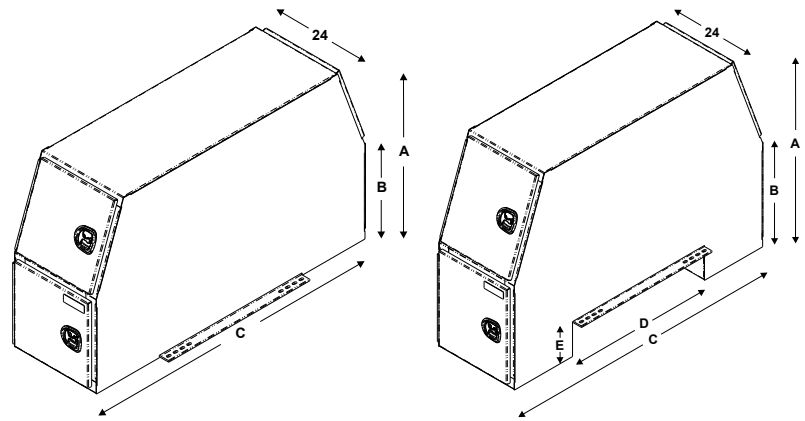
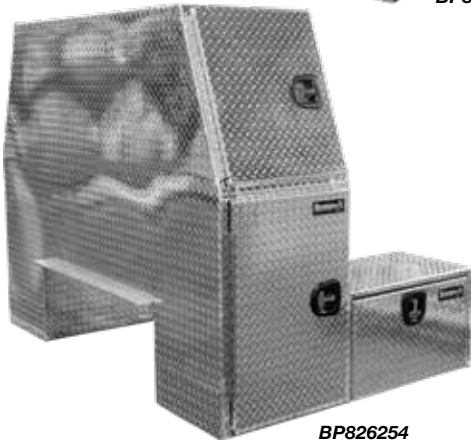

Part No.	Floor (E)	Application	Total Height (A / B)	Depth	Width (C / D)	Wt. (lb)	Cat.
BP824624	Flat Floor No Offset	Used on Cab-Over Trucks	46 / 24	24	81	216	592 (Y)
BP825524	Offset Floor (9.62")	Hangs Below Floor Level	55 / 28.62	24	81 / 42	234	592 (Y)
BP826224	Offset Floor (16.35")	Hangs Below Floor Level	55 / 18.5	24	81 / 42	254	592 (Y)
BP855924	Flat Floor No Offset	Used on Cab-Over Trucks	59 / 30	24	85	350	530 (Y)
BP925824	Offset Floor (9.62")	Hangs Below Floor Level	55 / 30.12	24	91 / 52	255	592 (Y)
NEW BP826254	Offset Floor (16.35")	Welded L-Backpack	55 / 18.5	54	81 / 42	628	592 (Y)
BP141624	Optional Bolt-On Aluminum Underbody Toolbox		14	16	24	32	530 (Y)

Universal Spring Cushion Mounting Kit for Backpack Truck Boxes

- Provides flex to reduce strain on aluminum B-pack truck boxes
- Ideal for off-road applications
- 5/8" U-bolts with forged tie bars, springs and fasteners (all zinc plated)
- Included with aluminum backpacks



Part No.	Description	Wt. (lb)	Cat.
3008086	Universal Spring Cushion Mounting Kit	17	531 (Y)

Failure to use supplied cushion mounting kit may void warranty on Aluminum Backpack Truck Boxes.
Additional sizes available as custom orders.

Backpack Mounting Adapter **NEW**

- Provides a level base with a pre-fabricated kit that ensure optimal fit and reduced installation time
- Black powder-coated bracket and zinc plated hardware add ultimate corrosion resistance



Part No.	Description	Wt. (lb)	Cat.
NEW 3037014	Backpack Mounting Adapter for Ford 2017+	47.24	531 (Y)

Diamond Tread Aluminum Trailer Tongue Truck Box

- .056 thick diamond tread aluminum
- Locking stainless steel paddle latch
- Aluminum continuous hidden hinge
- Designed to mount to the front of A-frame style trailers

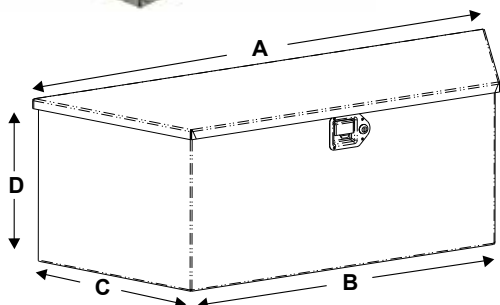

Part No.	Height (D)	Depth (C)	Width (A / B)	Wt. (lb)	Cat.
1701380	15	14.5	34 / 20.7	17.5	530 (Y)
1701385	18.5	15	49 / 37	28	530 (Y)

Black Steel Trailer Tongue Truck Box

- Built tough with a 14 Ga steel body and lid
- Locking stainless steel paddle latch
- Stainless steel continuous hidden hinge
- Designed to mount to the front of A-frame style trailers

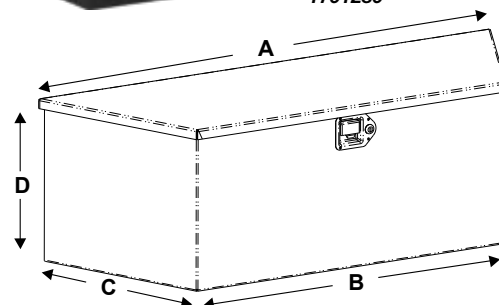

Part No.	Height (D)	Depth (C)	Width (A / B)	Wt. (lb)	Cat.
1701280	15	14.5	34 / 22.5	51	530 (Y)
1701281	12	13.25	26 / 14	33	530 (Y)
1701285	18.5	15	49 / 37	74	530 (Y)

Poly Trailer Tongue Toolbox

- Constructed of high-density polyethylene
- Stainless steel hasp and hinge
- Designed to mount to the front of A-frame style trailers

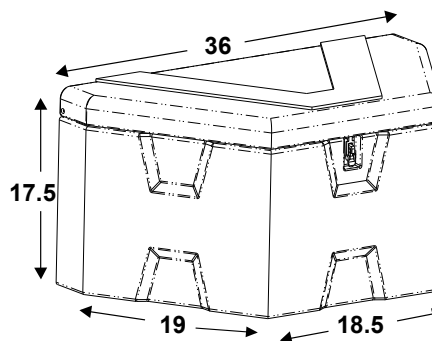

Black Poly Trailer Tongue Truck Box



Part No.	Height	Depth	Width	Wt. (lb)	Cat.
1701680	18	19	36 / 18	21	530 (Y)

White Poly Trailer Tongue Truck Box



Part No.	Height	Depth	Width	Wt. (lb)	Cat.
1701679	18	19	36 / 18	21	530 (Y)

Specialty

Heavy Duty Diamond Tread Aluminum Step Box

- Provides framed steps with built-in storage space
- Non-slip (grip punch) steps
- .125" smooth aluminum body
- .100" diamond tread aluminum door
- Single rubber D-bulb door seal protects from the elements
- Die-cast locking T-latch and continuous hinge
- Corner gussets on door opening provide extra strength
- 1/8" thick integral corner braces provide mounting support (for heavy loads and toolboxes wider than 18", #1701015 steel mounting brackets are recommended to prevent stress cracks)
- For medium and heavy-duty trucks



1705183



1705181

Part No.	Height	Depth	Width	Wt. (lb)	Cat.
1705180	24	28	12	40	530 (Y)
1705181	24	28	18	46	530 (Y)
1705182	24	28	24	56	530 (Y)
1705183	24	28	30	66	530 (Y)

Heavy Duty Diamond Tread Aluminum In-Frame Truck Box

- Body constructed of .100" smooth aluminum
- .100" Diamond tread aluminum lid is cross braced with .190" aluminum
- Full width stainless steel hinge with 1/4" diameter pin
- Overlapping lid design with full perimeter gutter and D-bulb seals
- TIG Welded
- Mounts between truck frame rails



Part No.	Height	Depth	Width	Wt. (lb)	Cat.
1705190	9	22	30	32	530 (Y)

18 Drawer Parts Cabinet

- Store and index hardware or small parts
- White powder coated steel cabinet
- Injection molded plastic drawers with stops
- Includes two dividers per drawer
- Pre-drilled mounting holes (hardware not included)



5411018



5411005

Part No.	Description	Height	Depth	Width	Wt. (lb)	Cat.
5411018	18 Drawer Cabinet	12	11-3/4	32-1/2	30.8	541 (N)
5411000	Drawer Replacement	3-1/4	12-1/4	5	0.61	541 (N)
5411005	Mounting Bracket for Cabinet	1-3/4	-	13-3/4	1.25	541 (N)

TOWING

Our towing equipment is designed and created to the highest industry standards.

PINTLE HOOKS AND PINTLE/BALL COMBINATIONS	B2
NEW 6 Ton and 10 Ton Pintle Hooks	B3
PINTLE HOOK MOUNTS	B5
NEW Style Mounts Available	B5
AIR COMPENSATED AND SWIVEL-TYPE PINTLE HOOKS	B6
GOOSENECK HITCHES AND ACCESSORIES	B10
KING PINS AND ACCESSORIES	B12
DRAWBARS	B13
HITCH PLATES AND ICC BUMPER	B15
NEW Style Hitch Plates Available	B15-B17
HITCH RECEIVERS	B17
MULTI-BALL HITCHES	B19
RECEIVER TUBES AND ADAPTERS	B21
HITCH BALL AND BALL MOUNTS	B23
NEW 2-1/2" Heavy Duty Forged Ball Mounts	B24
HITCH PINS	B27
SAFETY CHAINS AND ACCESSORIES	B28
WEIGHT DISTRIBUTION AND SWAY CONTROL	B30
TOWING HOOKS	B31
COUPLERS	B33
NEW Black Powder Coated Cast Coupler	B35
CAST EYE ASSEMBLIES	B36
BRAKE CONTROLLERS	B37
TRAILER CONNECTORS, ADAPTERS & ACCESSORIES	B38
TRAILER JACKS	B44

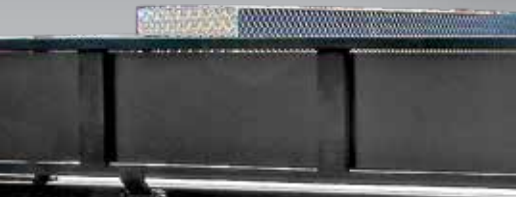

Combination Hitches

6-Ton Combination Hitch



RM62516

- Single piece drop forged lower jaw is designed with an integral shank to fit 2" receiver tubes
- Black powder coat finish
- Drawbar eye dimensions - 2-1/2" to 3" I.D. with 1-1/4" to 1-9/16" diameter section
- Individually boxed with instruction sheet & capacity decals

Part No.	Description	Ball Size	M.V.L. (lbs.)	M.G.T.W. (lbs.)	Wt. (lbs.)	Cat.
RM62000	6-Ton Receiver Mount Combination Hitch	2"	2,400	12,000	20	521 (Y)
RM62516	6-Ton Receiver Mount Combination Hitch	2-5/16"	2,400	12,000	20	521 (Y)
RM650M	6-Ton Receiver Mount Combination Hitch	50 mm	2,400	12,000	20	521 (Y)

8-Ton Combination Hitch



BH82000

- Drop forged
- Black powder coat finish
- Forged steel ball
- Interchangeable hitch balls
- Drawbar eye dimensions - 2-1/2" to 3" I.D. with 1-1/4" to 1-9/16" diameter section
- Individually boxed with drilling template & capacity decals
- M.G.T.W: 16,000 as pintle/12,000 as 1-7/8" or 2" ball mount, 16,000 as 2-5/16" ball mount

Part No.	Description	Ball Size	Mounting Pattern (Center to Center)		Fastener Size	M.V.L. (lbs.)	M.G.T.W. (lbs.)	Wt. (lbs.)	Cat.
			Vertical	Horizontal					
BH81780	8-Ton Combination Hitch	1-7/8"	1.75	3.38	1/2"	3,000	12,000	13	521 (Y)
10045	8-Ton Combination Hitch with Mounting Kit	1-7/8"	1.75	3.38	1/2"	3,000	12,000	13.8	521 (Y)
BH82000	8-Ton Combination Hitch	2"	1.75	3.38	1/2"	3,000	12,000	13	521 (Y)
10050	8-Ton Combination Hitch with Mounting Kit	2"	1.75	3.38	1/2"	3,000	12,000	13.8	521 (Y)
BH82516	8-Ton Combination Hitch	2-5/16"	1.75	3.38	1/2"	3,000	16,000	13	521 (Y)
10055	8-Ton Combination Hitch with Mounting Kit	2-5/16"	1.75	3.38	1/2"	3,000	16,000	13.8	521 (Y)
BH850MM	8-Ton Combination Hitch	50 mm	1.75	3.38	1/2"	3,000	16,000	13	521 (Y)

10-Ton Combination Hitch



BH102516

- Drop forged
- Black powder coat finish
- Forged steel ball
- Interchangeable hitch balls
- Drawbar eye dimensions - 2-3/8" to 3" up to 1-9/16" diameter section
- Individually boxed with drilling template & capacity decals
- M.G.T.W: 20,000 as pintle/20,000 as ball mount

Part No.	Description	Ball Size	Hole Spacing (Center to Center)		Hole Size	M.V.L. (lbs.)	M.G.T.W. (lbs.)	Wt. (lbs.)	Cat.
			Vertical	Horizontal					
BH102000	10-Ton Combination Hitch	2"	1.75	3.38	9/16"	4,000	20,000	19	521 (Y)
10052	10-Ton Combination Hitch with Mounting Kit	2"	1.75	3.38	9/16"	4,000	20,000	19	521 (Y)
BH102516	10-Ton Combination Hitch	2-5/16"	1.75	3.38	9/16"	4,000	20,000	20	521 (Y)
10057	10-Ton Combination Hitch with Mounting Kit	2-5/16"	1.75	3.38	9/16"	4,000	20,000	20	521 (Y)

Replacement Balls, Chains, and Mounting Hardware

Part No.	Description	Ball Size	Wt. (lbs.)	Cat.
RB1780	Replacement Ball for RM6 & BH8 Series	1-7/8"	2.25	521-1 (N)
RB2000	Replacement Ball for RM6 & BH8 Series	2"	2.5	521-1 (N)
RB2516	Replacement Ball for RM6 & BH8 Series	2-5/16"	2.75	521-1 (N)
RB50MM	Replacement Ball for RM6 & BH8 Series	50 mm	2.75	521-1 (N)
RB102000	Replacement Ball for BH10 Series	2"	3.3	521-1 (N)
RB102516	Replacement Ball for BH10 Series	2-5/16"	4	521-1 (N)
P11C	1/4" Zinc Clip with 8" Chain for RM6 & BH8 Series		0.13	521-1 (N)
3003316	3/8" Zinc Clip with 8" Chain for BH10 Series		0.13	525-1 (N)
8520	Mounting Kit: (4) 1/2" x 2" long Gr. 8 cap screws, 1/2" Gr. 8 hex nuts, 1/2" lock washers, 1/2" flat washers for BH8 Series		0.75	525-1 (N)
8525	Mounting Kit: (4) 9/16" x 2-1/2" long Gr. 8 cap screws, 9/16" Gr. 8 hex nuts, 9/16" lock washers, 9/16" flat washers for BH10 Series		3	525-1 (N)

5-Ton Receiver Tube Pintle Hook



RM5P

- Single piece drop forged lower jaw is designed with an integral shank to fit 2" receiver tubes
- Black powder coat finish
- Drawbar eye dimensions - 2" to 3" I.D. with 1-1/4" to 1-5/8" diameter section
- Individually boxed with instruction sheet and capacity decals



Part No.	Description	M.V.L. (lbs.)	M.G.T.W. (lbs.)	Wt. (lbs.)	Cat.
 RM5P	5-Ton Receiver Mount Pintle Hook	2,000	10,000	14.2	525 (N)
P11C	1/4" Zinc Clip with 8" Chain for RM Series			0.13	521-1 (N)

6-Ton Pintle Hook



PH6

- Drop forged steel
- Black powder coat finish
- Drawbar eye dimensions - 2" to 3" I.D. with 1-1/4" to 1-5/8" diameter section
- Individually boxed with instruction sheet, drilling template, and capacity decals
- PH6 compares to Holland®* PH-T-60-AL



Part No.	Description	M.V.L. (lbs.)	M.G.T.W. (lbs.)	Mounting Pattern (Center to Center)		Fastener Size	Wt. (lbs.)	Cat.
				Vertical	Horizontal			
 NEW PH6	6-Ton Pintle Hook	2,400	12,000	1.75	3.38	1/2"	11.34	525 (N)
 NEW 10036	6-Ton Pintle Hook with Mounting Kit	2,400	12,000	1.75	3.38	1/2"	12.89	525 (N)
8520	Mounting Kit: (4) 1/2" x 2" long Gr. 8 cap screws, 1/2" Gr. 8 hex nuts, 1/2" heavy lock washers, 1/2" flat washers						0.75	525-1 (N)
P11C	1/4" Zinc Clip with 8" Chain for PH6 Series						0.13	521-1 (N)

10-Ton Pintle Hook



PH10

- Drop forged steel
- Black powder coat finish
- Drawbar eye dimensions - 2" to 3" I.D. with 1-1/4" to 1-5/8" diameter section
- Individually boxed with instruction sheet, drilling template, and capacity decals

Part No.	Description	M.V.L. (lbs.)	M.G.T.W. (lbs.)	Mounting Pattern (Center to Center)		Fastener Size	Wt. (lbs.)	Cat.
				Vertical	Horizontal			
 NEW PH10	10-Ton Pintle Hook	4,000	20,000	1.75	3.38	1/2"	11.34	525 (N)
 NEW 10038	10-Ton Pintle Hook with Mounting Kit	4,000	20,000	1.75	3.38	1/2"	12.89	525 (N)
8520	Mounting Kit: (4) 1/2" x 2" long Gr. 8 cap screws, 1/2" Gr. 8 hex nuts, 1/2" heavy lock washers, 1/2" flat washers						0.75	525-1 (N)
P11C	1/4" Zinc Clip with 8" Chain for PH10 Series						0.13	521-1 (N)

* Buyers Products is not authorized by nor affiliated with the manufacturer of Holland® or Wallace® products.



Rigid-Type Pintle Hooks

15-Ton Pintle Hook



PH15

- Drop forged steel
- Black powder coat finish
- Drawbar eye dimensions - 2" to 3" I.D. with 1-1/4" to 1-5/8" diameter section
- Individually boxed with instruction sheet, drilling template, and capacity decals
- PH15 compares to Holland®* PH-T-60-AOL-8

Part No.	Description	M.V.L. (lbs.)	M.G.T.W. (lbs.)	Hole Spacing (Center to Center)		Fastener Size	Wt. (lbs.)	Cat.
				Vertical	Horizontal			
PH15	15-Ton Pintle Hook	6,000	30,000	1.75	3.38	1/2"	11	525 (N)
10040	15-Ton Pintle Hook with Mounting Kit	6,000	30,000	1.75	3.38	1/2"	11.8	525 (N)
8520	Mounting Kit: (4) 1/2" x 2" long Gr. 8 cap screws, 1/2" Gr. 8 hex nuts, 1/2" lock washers, 1/2" flat washers						0.75	525-1 (N)
P11C	1/4" Zinc Clip with 8" Chain for PH15 Series						0.13	521-1 (N)

20-Ton Pintle Hook



PH20

- Drop forged steel
- Black powder coat finish
- Drawbar eye dimensions - 2" to 3" I.D. with 1-1/4" to 1-5/8" diameter section
- Individually boxed with instruction sheet, drilling template, and capacity decals
- PH20 compares to Wallace®* 20 TON

Part No.	Description	M.V.L. (lbs.)	M.G.T.W. (lbs.)	Hole Spacing (Center to Center)		Fastener Size	Wt. (lbs.)	Cat.
				Vertical	Horizontal			
PH20	20-Ton Pintle Hook	8,000	40,000	1.75	3.38	9/16"	13.1	525 (N)
10042	20-Ton Pintle Hook with Mounting Kit	8,000	40,000	1.75	3.38	9/16"	13.4	525 (N)
8525	Mounting Kit: (4) 9/16" x 2-1/2" long Gr. 8 cap screws, 9/16" Gr. 8 hex nuts, 9/16" lock washers, 9/16" flat washers						3	525-1 (N)
P11C	1/4" Zinc Clip with 8" Chain for PH20 Series						0.13	521-1 (N)

30-Ton Pintle Hook



PH30

- Drop forged steel
- Black powder coat finish
- Drawbar eye dimensions - 2" to 3" I.D. with 1-1/4" to 1-5/8" diameter section
- Individually boxed with instruction sheet, drilling template, and capacity decals

Part No.	Description	M.V.L. (lbs.)	M.G.T.W. (lbs.)	Hole Spacing (Center to Center)		Fastener Size	Wt. (lbs.)	Cat.
				Vertical	Horizontal			
PH30	30-Ton Pintle Hook	15,000	60,000	4.50	4.50	3/4"	24	525 (N)
8530	Mounting Kit: (4) 3/4" x 3-1/2" long Gr. 8 cap screws, 3/4" Gr. 8 hex nuts, 3/4" flat washers						2.8	525-1 (N)
3003316	3/8" Zinc Clip with 8" Chain for PH30 Series						0.23	525 (N)

45-Ton Pintle Hook



PH45

- Austempered ductile iron
- Black powder coat finish
- Drawbar eye dimensions - 2-3/8" to 3" I.D. with 1-1/4" to 1-5/8" diameter section
- Individually boxed with instruction sheet, drilling template, and capacity decals
- PH45 compares to Premier®* Model 580



Part No.	Description	M.V.L. (lbs.)	M.G.T.W. (lbs.)	Hole Spacing (Center to Center)		Fastener Size	Wt. (lbs.)	Cat.
				Vertical	Horizontal			
PH45	45-Ton Pintle Hook	18,000	90,000	3.00	5.25/6.50	3/4"	23	525 (N)
8530	Mounting Kit: (4) 3/4" x 3-1/2" long Gr. 8 cap screws, 3/4" Gr. 8 hex nuts, 3/4" flat washers						2.8	525-1 (N)

* Buyers Products is not authorized by nor affiliated with the manufacturer of Holland® or Wallace® products.

2" Pintle Hook Mounts

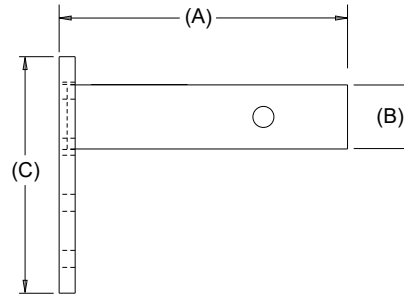
- Continuous welds
- Black powder coat finish
- High & low positioning
- Solid shank (tubular shank on PM25612)
- Welded support bracket
- Accepts PH5, PH8, PH15, PH20 (requires drilling), BH8 or similar pintle hooks





Part No.	A	B	C	Pairs of Holes	M.V.L. (lbs.)	M.G.T.W. (lbs.)	Hole Spacing (Center to Center)		Fastener Size	Wt. (lbs.)	Cat.
							Vertical	Horizontal			
PM84	9"	2"	3.75"	2	4,000	20,000	1.75	3.38	1/2"	12	544 (N)
PM87	9"	2"	7.38"	4	2,800	14,000	1.75	3.38	1/2"	15	544 (N)
 10033	9"	2"	7.38"	4	2,800	14,000	1.75	3.38	1/2"	15	544 (N)
 PM90	9"	2"	7.25"	4	2,800	17,000	1.75	3.38	1/2"	15.7	544 (N)
PM105	10.25"	2"	5.75"	3	3,000	15,000	1.75	3.38	1/2"	16	544 (N)
PM107	10.25"	2"	7.38"	4	2,600	13,000	1.75	3.38	1/2"	17	544 (N)
PM812	12.25"	2"	12.50"	7	2,000	10,000	1.75	3.38	1/2"	24	544 (N)
 10032	12.25"	2"	12.50"	7	2,000	10,000	1.75	3.38	1/2"	24	544 (N)
PM1012	14.5"	2"	12.50"	7	2,000	10,000	1.75	3.38	1/2"	26	544 (N)

2-1/2" Pintle Hook Mounts

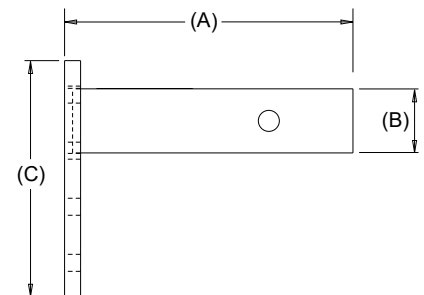

- Continuous welds
- Black powder-coated finish
- High & low positioning
- Tubular shank
- Welded support bracket
- Accepts PH5, PH8, PH15, PH20 (drilling required), BH8 or similar pintle hooks



Part No.	A	B	C	Pairs of Holes	M.V.L. (lbs.)	M.G.T.W. (lbs.)	Hole Spacing (Center to Center)		Fastener Size	Wt. (lbs.)	Cat.
							Vertical	Horizontal			
PM25612	12"	2.5"	6.13"	3	3,200	16,000	1.75	3.38	1/2"	12	544 (N)
 PM25812	11.25"	2.5"	7.14"	4	3,000	20,000	1.75	3.38	1/2"	18.21	544 (N)

Air Compensated Pintle Hooks

45-Ton Air Compensated Pintle Hook with 4 Mounting Holes



- **Must be used with a brake chamber**
- 4-Hole mount
- Double-safe locking system with a lock/clasp/ impact arm interacting design prevents release of the eye when air pressure is applied
- Drawbar eye dimensions: 2-3/8" & 3" I.D. with 1-1/4" to 1-3/4" dia. cross section

Part No.	Description	M.V.L. (lbs.)	M.G.T.W. (lbs.)	Hole Spacing (Center to Center)		Fastener Size	Wt. (lbs.)	Cat.
				Vertical	Horizontal*			
P45AC4K	45-Ton Air Compensated Pintle Hook Kit, Includes Pintle Hook, Brake Chamber & Bracket	18,000	90,000	3.00	5.25/6.50	3/4"	38.4	525 (N)
P45AC4	45-Ton Air Compensated Pintle Hook Only	18,000	90,000	3.00	5.25/6.50	3/4"	26	525 (N)

*All hole spacing listed in descending order

45-Ton Air Compensated Pintle Hook with 6 Mounting Holes



- **Must be used with a brake chamber**
- 6-Hole mount
- Double-safe locking system with a lock/clasp/ impact arm interacting design prevents release of the eye when air pressure is applied
- Drawbar eye dimensions: 2-3/8" & 2-5/8" I.D. with 1-5/8" to 1-3/4" dia. cross section

Part No.	Description	M.V.L. (lbs.)	M.G.T.W. (lbs.)	Hole Spacing (Center to Center)		Fastener Size	Wt. (lbs.)	Cat.
				Vertical*	Horizontal			
P45AC6K	45-Ton Air Compensated Pintle Hook Kit, Includes Pintle Hook, Brake Chamber & Bracket	18,000	90,000	2.38/2.13	5.00	3/4"	42	525 (N)
P45AC6	45-Ton Air Compensated Pintle Hook	18,000	90,000	2.38/2.13	5.00	3/4"	29.6	525 (N)

*All hole spacing listed in descending order

Air Chamber & Plunger Kit for 45-Ton



Part No.	Description	Wt. (lbs.)	Cat.
P45AC4MK	Brake Chamber Mount Kit for P45AC4	13.5	525 (N)
P45AC6MK	Brake Chamber Mount Kit for P45AC6	13.67	525 (N)
P45AC4BK	Brake Chamber Bracket Only, for P45AC4	3.2	525-1 (N)
3018091	Brake Chamber, Type 24, with 9-1/2" Rod Only	9.2	525-1 (N)
P45AC6BK	Brake Chamber Bracket Only, for P45AC6	3.2	525-1 (N)
3018091	Brake Chamber, Type 24, with 9-1/2" Rod Only	9.2	525-1 (N)

50-Ton Air Compensated Pintle Hook with 6 Mounting Holes



PH50AC



PH50

- Can be utilized with or without the air chamber & plunger
- Plunger provides minimum clearance with shock absorption
- Drawbar eye dimensions: 2-3/8" to 3" I.D. with 1-1/4" to 1-5/8" dia. cross section
- Black powder coat finish
- Reduce capacity by 25% for off road applications & use with swivel type trailer drawbar
- PH50 compares to: Wallace® R50-8 & Holland® PH410

Part No.	Description	M.V.L. (lbs.)	M.G.T.W. (lbs.)	Hole Spacing (Center to Center)		Fastener Size	Wt. (lbs.)	Cat.
				Vertical*	Horizontal			
PH50AC	Kit Includes 50-Ton Pintle Hook with Air Chamber & Plunger	20,000	100,000	2.38/2.13	5.00	3/4"	44.8	525 (N)
PH50	50-Ton Pintle Hook	20,000	100,000	2.38/2.13	5.00	3/4"	28.9	525 (N)
8530	Mounting Kit: (4) 3/4" x 3-1/2" long Gr. 8 cap screws, 3/4" Gr. 8 hex nuts, 3/4" flat washers						2.8	525-1 (N)

*All hole spacing listed in descending order

50-Ton Air Compensated Pintle Hook with 10 Mounting Holes



PH55AC



PH55

- Can be utilized with or without the air chamber & plunger
- Plunger provides minimum clearance with shock absorption
- Drawbar eye dimensions: 2-3/8" to 3" I.D. with 1-1/4" to 1-5/8" dia. cross section
- Black powder coat finish
- Reduce capacity by 25% for off road applications & use with swivel type trailer drawbar
- PH55 compares to: Wallace® R50-8 & Holland® PH400

Part No.	Description	M.V.L. (lbs.)	M.G.T.W. (lbs.)	Hole Spacing (Center to Center)		Fastener Size	Wt. (lbs.)	Cat.
				Vertical	Horizontal			
PH55AC	Kit Includes 50-Ton Pintle Hook with Air Chamber & Plunger	20,000	100,000	*see below	5.00	3/4"	54.5	525 (N)
PH55	50-Ton Pintle Hook	20,000	100,000	*see below	5.00	3/4"	38.6	525 (N)
8530	Mounting Kit: (4) 3/4" x 3-1/2" long Gr. 8 cap screws, 3/4" Gr. 8 hex nuts, 3/4" flat washers						2.8	525-1 (N)

*All hole spacing listed in descending order. PH55 family hole spacing 1.06/1.06/2.38/4.25

Air Chamber & Plunger Kit for 50-Ton



PH50ACMK

Part No.	Description	Wt. (lbs.)	Cat.
PH50ACMK	Chamber & Plunger Kit for PH50 & PH55	15.9	525 (N)
3018091	Brake Chamber, Type 24, with 9-1/2" Rod Only	9.2	525-1 (N)

* Buyers Products is not authorized by nor affiliated with the manufacturer of Premier®, Holland® or Wallace® products.



Products are Retail Packaged



Swivel-Type Pintle Hooks

15-Ton Swivel Type Pintle Hook



- Spring cushion
- Swivel action provides torsional relief of the coupling
- Recommended for off-road applications (capacities reduced by 25%)
- Drawbar eye dimensions - 2-3/8" to 3" I.D. with 1-1/4" to 1-5/8" diameter section
- Pintle hooks are individually boxed & include mounting information, spec. sheet, drilling template & vehicle capacity decal
- Compares to Holland®* PH-T-100A

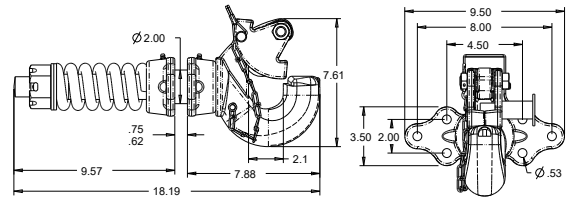

Part No.	Description	M.V.L. (lbs.)	M.G.T.W. (lbs.)	Hole Spacing (Center to Center)		Fastener Size	Wt. (lbs.)	Cat.
				Vertical	Horizontal			
BP100A	15-Ton Forged Swivel-Type	6,000	30,000	2.00	4.50/8.00	1/2"	37	525 (N)
8620	Mounting Kit: Six 1/2" x 2-1/2" long Gr. 8 cap screws; Six 1/2" Gr. 8 hex nuts; Six 1/2" heavy lock washers						1.3	525-1 (N)

15-Ton Swivel Type Pintle Hook



- Spring cushion
- Swivel action provides torsional relief of the coupling
- Recommended for off-road applications (capacities reduced by 25%)
- Drawbar eye dimensions - 2-3/8" to 3" I.D. with 1-1/4" to 1-5/8" diameter section
- Pintle hooks are individually boxed & include mounting information, spec. sheet, drilling template & vehicle capacity decal
- Compares to Holland®* PH-T-125A

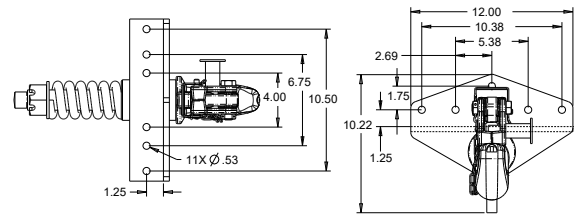

Part No.	Description	M.V.L. (lbs.)	M.G.T.W. (lbs.)	Hole Spacing (Center to Center)		Fastener Size	Wt. (lbs.)	Cat.
				Vertical	Horizontal			
BP125A	15-Ton Forged Swivel-Type	6,000	30,000	1.75	5.38/10.38	1/2"	37	525 (N)

25-Ton Swivel Type Pintle Hook



- Spring cushion
- Swivel action provides torsional relief of the coupling
- Recommended for off-road applications (capacities reduced by 25%)
- Drawbar eye dimensions - 2-3/8" to 3" I.D. with 1-1/4" to 1-5/8" diameter section
- Pintle Hooks are individually boxed & include mounting information, spec. sheet, drilling template & vehicle capacity decal
- BP200 compares to Wallace®* 25-TON

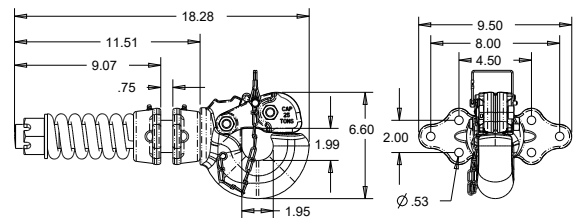

Part No.	Description	M.V.L. (lbs.)	M.G.T.W. (lbs.)	Hole Spacing (Center to Center)		Fastener Size	Wt. (lbs.)	Cat.
				Vertical	Horizontal			
BP200	25-Ton Forged Swivel-Type	6,000	50,000	2.00	4.50/8.00	1/2"	38.0	525 (N)
8620	Mounting Kit: Six 1/2" x 2-1/2" long Gr. 8 cap screws; Six 1/2" Gr. 8 hex nuts; Six 1/2" heavy lock washers						1.3	525-1 (N)

25-Ton Swivel Type Pintle Hook



- Spring cushion
- Swivel action provides torsional relief of the coupling
- Recommended for off-road applications (capacities reduced by 25%)
- Drawbar eye dimensions - 2-3/8" to 3" I.D. with 1-1/4" to 1-5/8" diameter section
- Pintle hooks are individually boxed & include mounting information, spec. sheet, drilling template & vehicle capacity decal
- BP225 compares to Wallace®* 25-TON

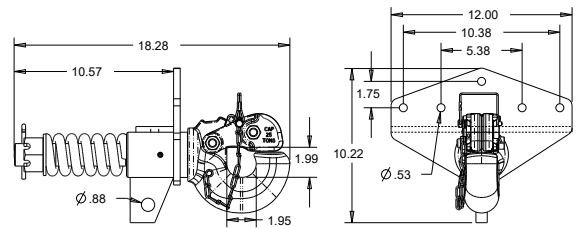

Part No.	Description	M.V.L. (lbs.)	M.G.T.W. (lbs.)	Hole Spacing (Center to Center)		Fastener Size	Wt. (lbs.)	Cat.
				Vertical	Horizontal			
BP225	25-Ton Forged Swivel-Type	6,000	50,000	1.75	5.38/10.38	1/2"	47.0	525 (N)
8620	Mounting Kit: Six 1/2" x 2-1/2" long Gr. 8 cap screws; Six 1/2" Gr. 8 hex nuts; Six 1/2" heavy lock washers						1.3	525-1 (N)

30-Ton Heavy Duty Swivel Type Pintle Hook



- Swivel action provides torsional relief of the coupling
- Drawbar eye dimensions - 3" to 3" I.D. with 1-5/8" diameter section
- Pintle hooks are individually boxed & include mounting information, spec. sheet, drilling template & vehicle capacity decal

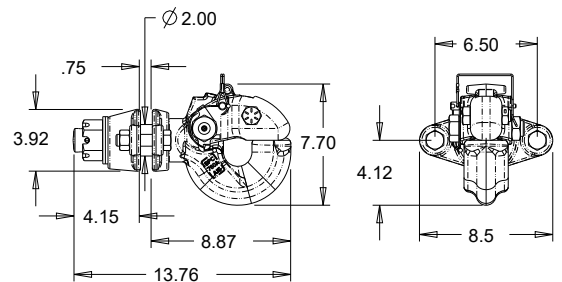

Part No.	Description	M.V.L. (lbs.)	M.G.T.W. (lbs.)	Hole Spacing (Center to Center)		Fastener Size	Wt. (lbs.)	Cat.
				Vertical	Horizontal			
BP760A	30-Ton Forged Swivel-Type	12,000	60,000	-	6.50	3/4"	38.3	525 (N)
3006875	1/4" Zinc Plated Safety Pin with Lanyard						0.15	525-1 (N)

50-Ton Heavy Duty Swivel Type Pintle Hook



- Swivel action provides torsional relief of the coupling
- Drawbar eye dimensions - 3" ID with 1-5/8" diameter cross section
- Heavy duty forged construction
- Black powder coat finish
- Easily accessible grease fitting
- Compares to Holland®* PH-775SL11 & PH-775-01552; Wallace®* B50 (2051108)

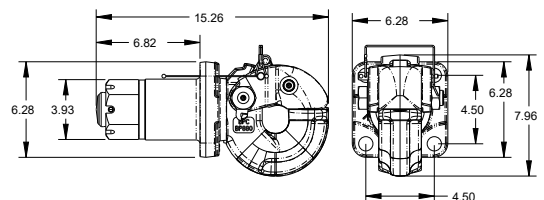

Part No.	Description	M.V.L. (lbs.)	M.G.T.W. (lbs.)	Hole Spacing (Center to Center)		Fastener Size	Wt. (lbs.)	Cat.
				Vertical	Horizontal			
BP880	50-Ton Forged Swivel-Type	20,000	100,000	4.50	4.50	7/8"	62	525 (N)

*Buyers Products is not authorized by nor affiliated with the manufacturer of Holland® or Wallace® products.

Gooseneck Hitches

Gooseneck Flip Ball Hitch



- 2-5/16" hitch ball
- 30,000 lbs. M.G.T.W.
- Includes vehicle specific mount (not shown)
- Underbed design
- Requires 4" hole in bed for flip ball

Part No.	Year/Model	Make	Truck Model	M.V.L. (lbs.)	M.G.T.W. (lbs.)	Wt. (lbs.)	Cat.
5613100	2001-2010 2007-2010	Chevy/GM	2500HD Long/Short Bed (1 Crossmember) 3500 Long/Short Bed (1 Crossmember)	7,500	30,000	110.6	561 (N)
5613101A	2011-2016+	Chevy/GM	2500HD/3500 Long/Short Bed	7,500	30,000	119.95	561 (N)
NEW 5613102	2019	Chevy/GM	2500HD/3500 Long/Short Bed	7,500	30,000	119	561 (N)
5613202	2017+	Ford	2500HD/3500 Long/Short Bed	7,500	30,000	110	561 (N)
5613200	1999-2010	Ford	F250/F350 Long/Short Bed	7,500	30,000	98	561 (N)
5613201	2011-2016	Ford	F250/F350 Long/Short Bed	7,500	30,000	92	561 (N)
5613300	2003-2009 2010-2012	RAM/Dodge	2500/3500 Long/Short Bed, Gas/Diesel 2500/3500 Long/Short Bed, Diesel ONLY	7,500	30,000	111	561 (N)
5613301	2006-2012 2010-2012	RAM/Dodge	1500/2500/3500 Megacab, Gas/Diesel 2500/3500 Long/Short Bed, Gas ONLY	7,500	30,000	122	561 (N)
5613302	2013	RAM/Dodge	2500 Long/Short Bed, Diesel ONLY	7,500	30,000	106.3	561 (N)
5613303	2013-2019	RAM/Dodge	3500 Long/Short Bed, AHU Option	7,500	30,000	49	561 (N)

Gooseneck Ball



- 2-5/16" towing ball zinc plated, yellow

Part No.	Description	M.V.L. (lbs.)	M.G.T.W. (lbs.)	Wt. (lbs.)	Cat.
3018195	2-5/16" Hitch Ball	5,000	25,000	8.4	561 (N)

Fabricators Kit for Flat-beds



- 2-5/16" towing ball zinc plated, yellow
- Flush mount, weld-on ball socket

Part No.	Description	M.V.L. (lbs.)	M.G.T.W. (lbs.)	Wt. (lbs.)	Cat.
5613500	Flat Bed Kit with 2-5/16" Hitch Ball	7,500	30,000	25	561 (N)

Gooseneck Hitch Plate



3014981

- 42"L x 13.5"T x 3/8" thick steel plate construction
- Black powder coated finish

Part No.	Description	M.V.L. (lbs.)	M.G.T.W. (lbs.)	Wt. (lbs.)	Cat.
G9542	Hitch Plate with 2-5/16" Hitch Ball without D-Rings	5,000	25,000	56.0	546 (N)
3014981	Hitch Plate with 2-5/16" Hitch Ball & D-Rings	5,000	25,000	71.2	546 (N)

Gooseneck Retractable Ball Hitch



G9003

- 360° locking collar secures the 2-5/16" towing ball when in the open position
- When in the closed position, the towing ball folds away & the locking collar secures flush

Part No.	Description	M.V.L. (lbs.)	M.G.T.W. (lbs.)	Wt. (lbs.)	Cat.
G9003	Gooseneck Retractable Ball Hitch	5,000	25,000	34	546 (N)
G9003UBK	Gooseneck Retractable Ball Hitch with U-Bolt Kit	5,000	25,000	36.4	546 (N)
 10070	Gooseneck Retractable Ball Hitch with U-Bolt Kit	5,000	25,000	36.4	546 (N)
BRB03	Safety Chain U-Bolt Kit for G9003 Series	5,000	25,000	2.3	546 (N)



King Pins, Fifth Wheel Hitches & King Pin Locks

Trailer King Pins



- Forged from AISI 8630 steel & heat treated to create & maintain a hardness of 302-363 BHN.
- Weldable
- 150,000 P.S.I. in ultimate strength
- Made in USA

Part No.	Description	Bolster Plate Thickness	Bolster Plate Hole Thickness	Wt. (lbs.)	Cat.
KP20025	2" Forged SAE King Pin	.25"	3"	13.03	535 (Y)
KP20031	2" Forged SAE King Pin	.31"	3"	12.95	535 (Y)
KP20038	2" Forged SAE King Pin	.38"	3"	13	535 (Y)
KP20050	2" Forged SAE King Pin	.50"	3"	13.2	535 (Y)
BKPT809B	2" Forged, Bolt-on with 8 Holes	.50"	3"	12.88	535 (Y)

Fifth Wheel Lube Disks with Retention Clip



- Durable poly disk with steel retention clip provides constant lubrication
- Sold in boxes of 5 only
- Eliminates the need for 5th wheel plate grease & time consuming cleaning
- Large surface area provides extra towing protection

Part No.	Description	Wt. (lbs.)	Cat.
FWD24	Fifth Wheel Disk (24" x .185" thick) with steel clip	4.25	546 (N)
FWD32	Fifth Wheel Disk (32" x .185" thick) with steel clip	5.11	546 (N)
FWD36	Fifth Wheel Disk (36" x .185" thick) with steel clip	6.51	546 (N)
FWRC	Fifth Wheel Steel Retention Clip	0.11	546 (N)

King Pin Lock



- Cast steel construction
- Quick assembly/disassembly
- Keyed alike

Part No.	Description	Wt. (lbs.)	Cat.
KPL200	2" King Pin Lock	4.17	535 (Y)

King Pin Lock With Safety Features



- Cast steel construction
- Cast hardened lock bolt
- Quick assembly/disassembly
- Theft deterrent
- Oversized housing & warning lanyard prevent inadvertent coupling
- Safety orange powder coat finish
- Keyed alike

Part No.	Description	Dia.	Height	Wt. (lbs.)	Cat.
KPL300	2" King Pin Lock, Heavy Duty	6.3"	3.33"	4.17	535 (Y)

Forged 4-Bolt Mount Drawbar



- Alloy steel forging
- Black powder coat finish
- Welded construction
- 4-1/2" Square hole pattern

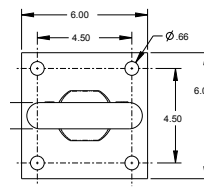

Part No.	Description	I.D. Eye	O.D. Eye	Section Drawbar	M.V.L. (lbs.)	M.G.T.W. (lbs.)	Mounting Pattern (Center to Center)		Fastener Size	Wt. (lbs.)	Cat.
							Vertical	Horizontal			
BDB125015W	Welded 4-Bolt Mount	2-1/2"	5-1/2"	1-1/2"	7,000	42,000	4.50	4.50	5/8"	14.0	527 (N)

Forged 4-Bolt Mount Drawbar



BDB1385

- One piece forged design for safety & capacity
- Alloy steel forging
- Black powder coat finish
- 4 hole square mounting plate

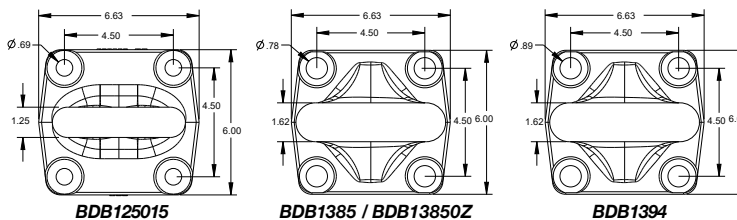

Part No.	Description	I.D. Eye	O.D. Eye	Section Drawbar	M.V.L. (lbs.)	M.G.T.W. (lbs.)	Mounting Pattern (Center to Center)		Fastener Size	Wt. (lbs.)	Cat.
							Vertical	Horizontal			
BDB125015	Forged 4-Bolt Mount	2-1/2"	5-1/2"	1-1/4" x 1-1/2"	7,000	42,000	4.50	4.50	5/8"	17.1	527 (N)
BDB1385	Heavy Duty Forged 4-Bolt Mount	3"	6.24"	1-5/8"	15,000	60,000*	4.50	4.50	3/4"	20	527 (N)
BDB13850Z	Heavy Duty Forged 4-Bolt Mount Zinc plated, clear	3"	6.24"	1-5/8"	15,000	60,000*	4.50	4.50	3/4"	20	527 (N)
BDB1394	Heavy Duty Forged 4-Bolt Mount	3"	6.24"	1-5/8"	19,000	90,000	4.50	4.50	7/8"	20	527 (N)

*90,000 lb. capacity for hinged tongue trailers where there is a negligible tongue load (500 lbs. max)

Trailer Nose Plate For Mounting Drawbar



- Accepts standard 4-1/2" square bolt pattern found on most drawbars
- 3 mounting positions
- TNP716625750 is used with BDB125015 and similar drawbars
- TNP716750100 is used with BDB1385 and similar drawbars

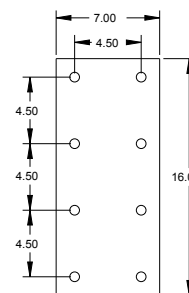

Part No.	Description	Mounting Pattern (Center to Center)		Fastener Size	Wt. (lbs.)	Cat.
		Vertical	Horizontal			
TNP716625750	Trailer Nose Plate (3/4" thick)	4.50	4.50	5/8"	24	527 (N)
TNP716750100	Trailer Nose Plate (1" thick)	4.50	4.50	3/4"	32	527 (N)

Forged Lunette Eye



- Forged steel

Part No.	Description	I.D. Eye	O.D. Eye	Section Drawbar	Wt. (lbs.)	Cat.
LW625	Forged Lunette Eye	3"	5"	1"	2.9	527 (N)
LW847	Forged Lunette Eye	3"	6-1/4"	1-5/8"	9	527 (N)

Drawbars

Weld-On Forged Steel Drawbar



- Forged C1020 steel
- Welds onto trailer tongue

Part No.	Description	I.D. Eye	O.D. Eye	Section Drawbar	M.V.L. (lbs.)	M.G.T.W. (lbs.)	Wt. (lbs.)	Cat.
LW10	Forged Steel	2-1/2"	4-1/2"	1"	1,000	10,000	4	527 (N)
LW20	Forged Steel	3"	6-1/4"	3-3/8 x 1-1/4"	4,000	20,000	12.52	527 (N)

Bolt-On Forged Steel Drawbar



- Bolt-on drawbar

Part No.	Description	I.D. Eye	O.D. Eye	Section Drawbar	M.V.L. (lbs.)	M.G.T.W. (lbs.)	Wt. (lbs.)	Cat.
BDB12281	Forged Steel	2-1/2"	5-1/2"	1-1/4" x 1-1/2"	4,000	20,000	20.25	527 (N)
BDB1238	Forged Alloy Steel	3"	6-1/4"	1-5/8"	4,500	22,000	27	527 (N)

Forged Alloy Steel Drawbar With Nut



- Alloy steel forging
- Includes nut, cotter pin, and washer

Part No.	Description	I.D. Eye	O.D. Eye	Section Drawbar	M.V.L. (lbs.)	M.G.T.W. (lbs.)	Wt. (lbs.)	Cat.
BDB12503	1.5-12 x 2.12	2-1/2"	5-1/2"	1-1/4" x 1-1/2"	3,000	15,000	9	527 (N)
BDB12492H	2-4.5 x 2.5	3"	6-1/4"	1-5/8"	9,000	45,000	16	527 (N)

Drawbar Lock



- Zinc plated
- Fits all 2-1/2" - 3" lunette eyes
- 2-1/32" hole accept most 1/2" dia. padlocks
- Shown with drawbar & lock (not included)

Part No.	Description	Wt. (lbs.)	Cat.
BDL253	Drawbar Lock	3.5	527 (N)

Drawbar Wear Gauge



Part No.	Description	Wt. (lbs.)	Cat.
3013872	Drawbar Wear Gauge	0.98	543 (N)

Hitch Plate for Pintle Mount



- Fits Ford F350, F450, F550, Chevy/GMC 3500, 4500 & 5500 Chassis Cabs & Dodge/RAM 3500
- Includes two 5/8" forged D-rings with brackets
- Multiple pintle hook mounting positions
- Pre-punched hole fits multiple trailer connectors
- Black powder coat finish
- Includes ICC bumper protection

Part No.	Description	Application	Channel Location	M.G.T.W. (lbs.)	Wt. (lbs.)	Cat.
1809030B	1/2" x 15.5" H	Ford F350, F450, F550, 1999+	Side	20,000	104	551 (Y)
NEW 1809031A	1/2" x 15.5" H	Ford F350, F450, F550, 1999+	Bottom	20,000	119	551 (Y)
1809035A	1/2" x 15.5" H	Chevy/GMC 3500	Side	20,000	90	551 (Y)
1809036	1/2" x 17" H	Chevy/GMC 3500	Bottom	20,000	107	551 (Y)
1809037A	1/2" x 15" H	Dodge/RAM 3500, 4500, 5500	Side	20,000	108	551 (Y)
1809038A	1/2" x 17.125" H	Chevy/GMC 4500/5500	Side	20,000	107	551 (Y)
1809039A	1/2" x 22" H	Chevy/GMC 4500/5500, 4x4	Side	20,000	131	551 (Y)

Fabricators Hitch Plate



- 1/2", 5/8", 3/4" or 1" hitch plate
- Multiple pintle hook mounting positions
- Pre-punched hole fits multiple trailer connectors
- Includes two 5/8" forged D-rings with brackets on the 1/2" model and two 1" forged D-rings on the 5/8", 3/4" and 1" models
- Includes two weld-on gussets

Part No.	Description	M.G.T.W. (lbs.)	Wt. (lbs.)	Cat.
1809040	1/2" x 34" W x 15.5" H, Fabricators	Not Rated	71	551 (Y)
1809042	5/8" x 34" W x 15.5" H, Fabricators	Not Rated	93	551 (Y)
1809043	5/8" x 34.5" W x 22.5" H, Fabricators	Not Rated	131	551 (Y)
1809027A	3/4" x 34.5" W x 23.5" H, Fabricators	Not Rated	168.2	551 (Y)
NEW 1809029	1 X 34-1/2 X 22-1/2 Inch, Fabricators	Not Rated	217.24	551 (Y)

Hitch Plate with 2" Receiver Tube



- Fits Ford, Chevy/GMC & Dodge/RAM
- Two 5/8" forged D-rings with brackets
- 2" receiver tube
- Pre-punched hole fits multiple trailer connectors
- Black powder coat finish
- Includes ICC bumper protection

Part No.	Description	Application	Receiver Tube	Channel Location	M.G.T.W. (lbs.)	Wt. (lbs.)	Cat.
1809060A	1/2" x 17.42" H	Ford F350, F450, F550	2"	Bottom	20,000	123	551 (Y)
1809065	1/2" x 16.91" H	Chevy/GMC 3500	2"	Bottom	20,000	111	551 (Y)
1809067	1/2" x 17.64" H	Dodge/RAM 3500, 4500, 5500	2"	Bottom	20,000	127	551 (Y)

Hitch Plate with 2-1/2" Receiver Tube



- Fits Ford, Chevy/GMC & Dodge/RAM
- Two 5/8" forged D-rings with brackets
- 2-1/2" receiver tube
- Pre-punched hole fits multiple trailer connectors
- Black powder coat finish
- Includes ICC bumper protection

Part No.	Description	Application	Receiver Tube	Channel Location	M.G.T.W. (lbs.)	Wt. (lbs.)	Cat.
1809061A	1/2" x 17.42" H	Ford F350, F450, F550	2-1/2"	Bottom	20,000	124	551 (Y)
NEW 1809075	1/2" x 16.91 H	Chevy/GMC 3500	2-1/2"	Bottom	20,000	112	551 (Y)
NEW 1809077	1/2" x 17.39 H	Dodge/RAM 3500, 4500, 5500	2-1/2"	Bottom	20,000	127	551 (Y)

Please consult vehicle/chassis owner's manual prior to installation. Take all safety precautions to protect the electrical components of the vehicle and/or chassis. All hitches listed above should be welded, and bolted to the frame with 1/2" bolts.

Flatbed/Flatbed Dump Hitch Plate Bumper for Pintle Mount



- Universal fit provides ICC bumper protection
- Two position pintle hook mounting
- Includes two 5/8" forged D-rings with brackets
- Standard mounting holes for Ford F350, F450, F550 (drilling required for GM trucks)
- Pre-punched hole fits multiple trailer connectors
- Requires minimum of two 3" welds per side

Part No.	Description	M.G.T.W. (lbs.)	Wt. (lbs.)	Cat.
1809050	Flatbed Dump Hitch Bumper 16.17" H	20,000	117	551 (Y)

Flatbed/Flatbed Dump Hitch Plate Bumper with 2" Receiver Tube



- Universal fit provides ICC bumper protection
- 2" receiver tube
- Includes two 5/8" forged D-rings with brackets
- Standard mounting holes for Ford F350, F450, F550 (drilling required for GM trucks)
- Pre-punched hole fits multiple trailer connectors
- Requires minimum of two 3" welds per side

Part No.	Description	Receiver Tube	M.G.T.W. (lbs.)	Wt. (lbs.)	Cat.
1809055	Flatbed Dump Hitch Receiver Bumper 16.17" Tall	2"	17,000	124	551 (Y)

Flatbed/Flatbed Dump Hitch Plate Bumper with 2-1/2" Receiver Tube



- Universal fit provides ICC bumper protection
- 2-1/2" receiver tube
- Includes two 5/8" forged D-rings with brackets
- Standard mounting holes for Ford F350, F450, F550 (drilling required for GM trucks)
- Pre-punched hole fits multiple trailer connectors
- Requires minimum of two 3" welds per side

Part No.	Description	Receiver Tube	M.G.T.W. (lbs.)	Wt. (lbs.)	Cat.
NEW 1809070	Flatbed Dump Hitch Receiver Bumper	2-1/2"	20,000	123.52	551 (Y)

ICC Bumper



- Heavy duty 4" structural steel construction
- Black powder coat finish

Part No.	Description	Wt. (lbs.)	Cat.
1809025	62" L x 17.5" H	42.5	519 (Y)

Please consult vehicle/chassis owner's manual prior to installation. Take all safety precautions to protect the electrical components of the vehicle and/or chassis. All hitches listed above should be welded, and bolted to the frame with 1/2" bolts.

Class 4 Service Body Hitch with 2" Receiver



- Heavy duty design for Stahl® service bodies
- 2" receiver tube
- Black powder coat finish
- 1801053 short hitch receiver fits Challenger®, recessed bumper;
- 1801055 long hitch receiver fits Challenger®, Grand Challenger®

Part No.	Description	M.V.L. (lbs.)	M.G.T.W. (lbs.)	Wt. (lbs.)	Cat.
1801053	Service Body Short Hitch, 2" Receiver	1,000	10,000	65	532 (Y)
1801055	Service Body Long Hitch, 2" Receiver	1,000	10,000	65.5	532 (Y)

Class 4 Service Body Hitch with 2-1/2" Receiver



- Heavy duty design for Stahl® service bodies
- 2-1/2" receiver tube
- Black powder coat finish
- 1801059 long hitch receiver fits Challenger®, Grand Challenger®

Part No.	Description	M.V.L. (lbs.)	M.G.T.W. (lbs.)	Wt. (lbs.)	Cat.
NEW 1801059	Service Body Long Hitch, 2-1/2" Receiver	1,000	10,000	71.83	532 (Y)

Class 5 Service Body Hitch with 2" Receiver

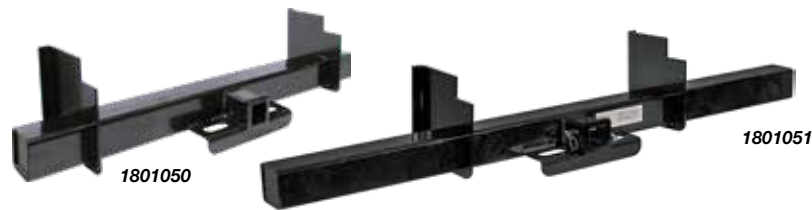

- Available with 2" tube
- Heavy duty design for service bodies
- Black powder coat finish
- Includes 5/8" hitch pin with cotter
- Includes mounting plates
- Available with no brackets
- Available unpainted

Part No.	Description	Length	Mounting Plate Height	M.V.L. (lbs.)	M.G.T.W. (lbs.)	Wt. (lbs.)	Cat.
1801050	2" Service Body Hitch	44"	9"	1,600	16,000	48.7	532 (Y)
1801050L	2" Service Body Hitch	44"	18.29"	1,600	16,000	48.7	532 (Y)
1801051	2" Platform Body Hitch	62"	9"	1,600	16,000	62.0	532 (Y)
1801051L	2" Platform Body Hitch	62"	18.29"	1,600	16,000	62.0	532 (Y)
3006909	2" Service Body Hitch	44"	—	1,600	16,000	39.0	532 (Y)

Class 5 Service Body Hitch with 2-1/2" Receiver

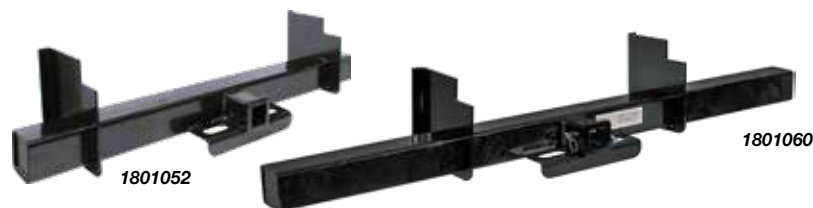

- Available with 2-1/2" tube
- Heavy duty design for platform bodies
- Black powder coat finish
- Includes 5/8" hitch pin with cotter
- Includes mounting plates
- Available with no brackets
- Available unpainted

Part No.	Description	Length	Mounting Plate Height	M.V.L. (lbs.)	M.G.T.W. (lbs.)	Wt. (lbs.)	Cat.
1801052	2-1/2" Service Body Hitch	44"	9"	2,000	20,000	49.2	532 (Y)
1801052L	2-1/2" Service Body Hitch	44"	18.29"	2,000	20,000	48.7	532 (Y)
NEW 1801060	2-1/2" Platform Body Hitch	62"	9"	2,000	20,000	62.23	532 (Y)
1801060L	2-1/2" Platform Body Hitch	62"	18.29"	2,000	20,000	89.0	532 (Y)
3018538	2-1/2" Service Body Hitch	44"	—	1,600	16,000	40.0	532 (Y)

Buyers Products is not authorized by nor affiliated with the manufacturer of Stahl® products.



Products are Retail Packaged



Hitch Receivers

Class 5 Hitch with 2" Receiver



- Accepts all 2" hitch accessories
- Heavy duty design for Dodge/RAM, Ford & GM
- Black powder coat finish
- Available with 2" tube
- Includes 5/8" hitch pin with cotter
- Includes all hardware required for installation
- Available for use on cut-away service bodies

Part No.	Description	M.V.L. (lbs.)	M.G.T.W. (lbs.)	Wt. (lbs.)	Cat.
1801100	2" Hitch Receiver for GM Express/Savanna, 1996-2015	1,200	12,000	57	532 (Y)
1801102	2" Hitch Receiver for GM Express/Savanna, for use with cutaway chassis 1996-2015	1,200	12,000	57	532 (Y)
1801111	2" Hitch Receiver for GM Cab & Chassis, 2011+	1,600	16,000	57	532 (Y)
1801119	2" Hitch Receiver for GM 2500/3500 Pickup, No Short Bed, 2011+	1,600	16,000	75	532 (Y)
1801208A	2" Hitch Receiver for Ford Cab & Chassis F350, 2009-2016	1,600	16,000	62	532 (Y)
1801214	2" Hitch Receiver for Ford F450/F550 Pickup, 2011-2016	1,700	17,000	62	532 (Y)
NEW 1801215	2" Hitch Receiver for Ford F450/F550 Extended 2011+	2,000	20,000	82	532 (Y)
NEW 1801220	2" Hitch Receiver for Ford F350 Extended 2011+	2,000	20,000	82	532 (Y)
1801301	2" Multi-Fit Hitch Receiver for Dodge/RAM, Ford & GM	1,600*	16,000*	64	532 (Y)
NEW 1801302	2" Hitch Receiver For Ram 3500 Bed Deletes 2013+	1,700	17,000	75	532 (Y)
NEW 1801310	2" Hitch Receiver For Ram 2500 Bed Deletes 2014+	1,700	17,000	81	532 (Y)
1801401	2" Multi-Fit Hitch Receiver for Ford & GM for use with cutaway service bodies (Mounting Hardware Not Included)	1,600*	16,000*	72.9	532 (Y)

*Weight Distribution rating. Standard rating: 1,500 lbs. M.V.L., 15,000 lbs. M.G.T.W.

Class 5 Hitch Receiver With 2-1/2" Receiver



- Accepts all 2-1/2" hitch accessories
- Black powder coat finish
- Includes 5/8" hitch pin with cotter
- Does not include mounting hardware

Part No.	Description	M.V.L. (lbs.)	M.G.T.W. (lbs.)	Wt. (lbs.)	Cat.
1801400	2-1/2" Multi-Fit Hitch Receiver for Ford & GM for use with cutaway service bodies	1,600*	16,000*	74	532 (Y)
NEW 1801500	2-1/2" Hitch Receiver For GM and Dodge/RAM Cab & Chassis 1999+	3,000	22,000	71	532 (Y)
1801510	2-1/2" Hitch Receiver For Ford F350-650 Cab & Chassis 1999+	3,000	22,000	75	532 (Y)

*Weight Distribution rating. Standard rating: 1,500 lbs. M.V.L., 15,000 lbs. M.G.T.W.

Accessory/Light Towing Hitch Receiver



- Accepts 2" receiver-mounted accessories
- Ideal for light towing, bike & cargo racks
- Universal fit; 6-1/2' (78") wide
- Black powder coat finish
- Mounting kit included (drilling required)
- Ships in two pieces: receiver (bulk) & mounting kit (boxed)

Part No.	Description	M.V.L. (lbs.)	M.G.T.W. (lbs.)	Wt. (lbs.)	Cat.
1801125	Trailer Accessory Receiver	300	3,000	55	532 (Y)

Accessory Hitch Receiver



- Accepts 2" receiver-mounted accessories **(not for towing)**
- Universal fit; 6-1/2' (78") wide
- Black powder coat finish
- Mounting kit included (drilling required)
- Ships in two pieces: receiver (bulk) & mounting kit (boxed)

Part No.	Description	Wt. (lbs.)	Cat.
1801120	Trailer Accessory Receiver	70	532 (Y)

Tri-Ball Hitch



1802202



1802205

- Solid or tubular shank for 2" receiver tubes
- Black or chrome welded steel balls
- Black powder coat finish
- 5/8" hitch pin hole
- Patent #8,684,389

Part No.	Description	Shank Type	Towing Ball Finish	M.G.T.W. (lbs.) 1-7/8" Ball Size	M.G.T.W. (lbs.) 2" Ball Size	M.G.T.W. (lbs.) 2-5/16" Ball Size	Wt. (lbs.)	Cat.
1802200	Ball Sizes: 1-7/8", 2", 2-5/16"	Solid	Black	6,000	7,500	10,000	19.5	539 (Y)
1802202	Ball Sizes: 1-7/8", 2", 2-5/16"	Tubular	Black	6,000	7,500	10,000	11.9	539 (Y)
1802205	Ball Sizes: 1-7/8", 2", 2-5/16"	Solid	Chrome	6,000	7,500	10,000	19.5	539 (Y)
1802207	Ball Sizes: 1-7/8", 2", 2-5/16"	Tubular	Chrome	6,000	7,500	10,000	11.9	539 (Y)

Tri-Ball Hitch with Recovery Hook



- Tubular shank for 2" receiver tubes
- Black welded steel towing balls
- Black powder coat finish
- 5/8" hitch pin hole
- Patent #8,684,389

Part No.	Description	Shank Type	M.G.T.W. (lbs.) 1-7/8" Ball Size	M.G.T.W. (lbs.) 2" Ball Size	M.G.T.W. (lbs.) 2-5/16" Ball Size	Wt. (lbs.)	Cat.
1802208	Ball Sizes: 1-7/8", 2", 2-5/16"	Tubular	6,000	7,500	10,000	13.4	539 (Y)

Adjustable Tri-Ball Hitch with Chrome Balls



1802225

- Solid shank for 2" receiver tubes
- Chrome welded steel towing balls
- Black powder coat finish
- 5/8" hitch pin hole
- 12" of vertical adjustment

Part No.	Description	Shank Type	M.G.T.W. (lbs.) 1-7/8" Ball Size	M.G.T.W. (lbs.) 2" Ball Size	M.G.T.W. (lbs.) 2-5/16" Ball Size	Wt. (lbs.)	Cat.
1802225	Ball Sizes: 1-7/8", 2", 2-5/16"	Solid	6,000	7,500	10,000	44	539 (Y)
3020620	Replacement Tri-Ball Chrome Towing Balls		—			8.75	521 (Y)

Tri-Ball Hitch with Pintle Hook



- Solid shank for 2" receiver tubes
- Chrome welded steel towing balls
- Black powder coat finish
- 5/8" hitch pin hole
- 7,500 lbs. cast steel pintle jaw
- Upper jaw locks in closed position (down) for lunette eye towing

Part No.	Description	Shank Type	M.G.T.W. (lbs.) 1-7/8" Ball Size	M.G.T.W. (lbs.) 2" Ball Size	M.G.T.W. (lbs.) 2-5/16" Ball Size	M.G.T.W. (lbs.) Pintle Hook	Wt. (lbs.)	Cat.
1802279	Ball Sizes: 1-7/8", 2", 2-5/16"	Solid	6,000	7,500	10,000	7,500	23	539 (Y)



Multi-Ball Hitches

Dual Ball Hitch



- Solid shank for 2" receiver tubes
- Black welded steel towing balls
- Black powder coat finish
- 5/8" hitch pin hole

Part No.	PKG. Part No.	Description	Shank Type	M.G.T.W. (lbs.) 2" Ball Size	M.G.T.W. (lbs.) 2-5/16" Ball Size	Wt. (lbs.)	Cat.
1802215	861215	Ball Sizes: 2", 2-5/16"	Solid	7,500	10,000	17	539 (Y)

Dual Ball Hitch with Drop



- Fits 2" receiver tubes
- Welded steel construction
- Black powder coat finish
- Larger diameter ball on bottom

Part No.	Description	Shank Type	Length	Max Drop	M.V.L. (lbs.)	M.G.T.W. (lbs.)	Wt. (lbs.)	Cat.
1803210	Double Ball Mount, (1-7/8" & 2" balls)	Tubular	8"	2"	600	6,000	7.75	536 (Y)
1803215	Double Ball Mount, (2" & 2-5/16" balls)	Tubular	8"	2"	600	6,000	11	536 (Y)

TUBULAR VS. SOLID TRI-BALL DESIGNS

In load testing per SAE J684, the Buyers Products patented tubular design (Patent # 8,684,389 B2) is equivalent or superior to the traditional solid design. This is possible because the 2-5/16" ball design allows it to pass through the complete shaft (see figure).

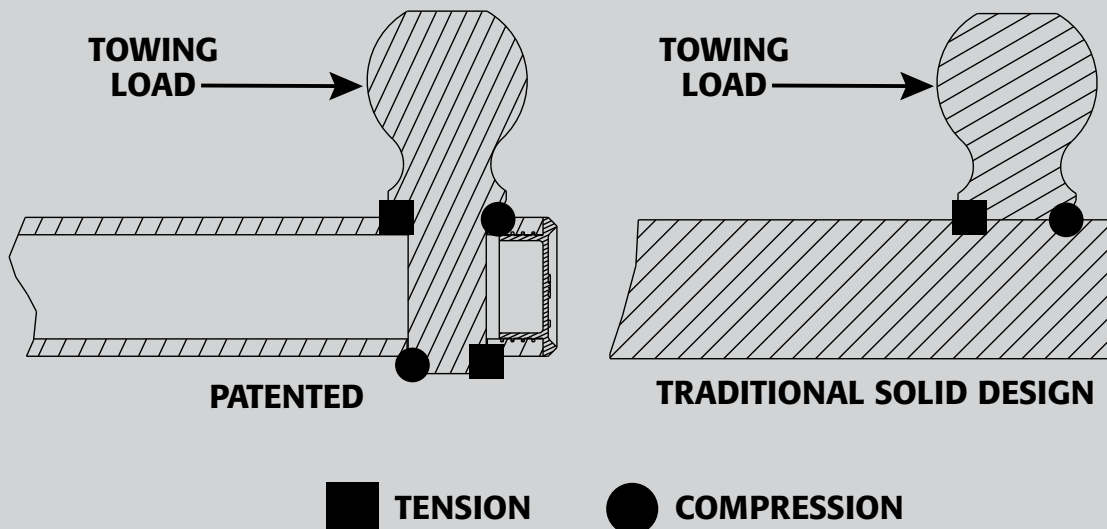

Receiver Tubes



RT1251206



RT25806



RT255808

- 1-1/4", 2", or 2-1/2" receiver tubes
- Cast steel collar on 2" models
- Finish options available
- Solid stress collar opening
- 5/8" Hitch pin hole (2" & 2-1/2" tubes); 1/2" Hitch pin hole (1-1/4" tubes)

1-1/4" RECEIVER TUBES

Part No.	Dimensions	Finish	Wt. (lbs.)	Cat.
RT1251206	1-1/4" I.D. x 6"	Black	1.8	532 (Y)
RT1251206UP	1-1/4" I.D. x 6"	Plain	1.8	532 (Y)

2" RECEIVER TUBES

Part No.	Dimensions	Finish	Wt. (lbs.)	Cat.
RT25806B	2" I.D. x 6"	Black	4	532 (Y)
RT25808	2" I.D. x 8"	Plain	5	532 (Y)
RT25808B	2" I.D. x 8"	Black	5	532 (Y)
RT25810	2" I.D. x 10"	Plain	6	532 (Y)
RT25810B	2" I.D. x 10"	Black	6	532 (Y)
RT25812	2" I.D. x 12"	Plain	7	532 (Y)
RT25812B	2" I.D. x 12"	Black	7	532 (Y)
RT25814	2" I.D. x 14"	Plain	8.3	532 (Y)
RT25814B	2" I.D. x 14"	Black	8.3	532 (Y)
RT25818	2" I.D. x 18"	Plain	10	532 (Y)

2" RECEIVER TUBES, continued

Part No.	Dimensions	Finish	Wt. (lbs.)	Cat.
RT25818B	2" I.D. x 18"	Black	10	532 (Y)
RT25824	2" I.D. x 24"	Plain	14	532 (Y)
RT25824B	2" I.D. x 24"	Black	14	532 (Y)
RT25836	2" I.D. x 36"	Plain	20	532 (Y)
RT25836B	2" I.D. x 36"	Black	20	532 (Y)
RT25848	2" I.D. x 48"	Plain	27	532 (Y)
RT25848B	2" I.D. x 48"	Black	27	532 (Y)

2-1/2" RECEIVER TUBES

Part No.	Dimensions	Finish	Wt. (lbs.)	Cat.
NEW RT255806	2-1/2" I.D. x 6"	Plain	4.89	532 (Y)
RT255808	2-1/2" I.D. x 8"	Plain	7.55	532 (Y)
RT255812	2-1/2" I.D. x 12"	Plain	11.33	532 (Y)
RT255818	2-1/2" I.D. x 18"	Plain	17	532 (Y)

Bolt-On Receiver Tube



- Bolts across two standard pintle hook hole patterns
- Cast steel collar with solid stress opening
- Black powder coat finish
- 5/8" Hitch pin hole
- Uses hardware kit 8520

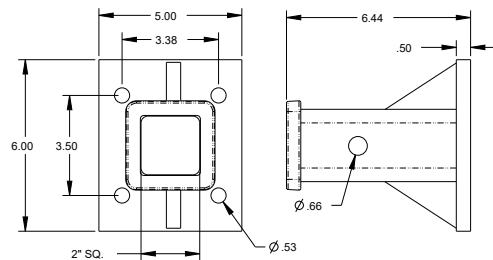

Part No.	Description	M.V.L. (lbs.)	M.G.T.W. (lbs.)	Mounting Pattern (center to center)		Fastener Size	Wt. (lbs.)	Cat.
				Vertical	Horizontal			
1804055	2" I.D. x 6", welded to 1/2" steel mounting plate	2,000	20,000	3.50	3.38	1/2"	7.9	532 (Y)
8520	Mounting Kit: (4) 1/2" x 2" long Gr. 8 cap screws, 1/2" Gr. 8 hex nuts, 1/2" lock washers, 1/2" flat washers						0.75	525-1 (N)

Receiver Tube Hitch Adapters



1804030



1804035



RTA252



RTA302

- Rounded corners
- 5/8" Hitch pin hole

Part No.	Description	Finish	M.V.L. (lbs.)	M.G.T.W. (lbs.)	Wt. (lbs.)	Cat.
1804030	1-1/4" to 2" Hitch Adapter	Black Powder Coat	300	Not rated for towing	7	532 (Y)
1804035	2" to 1-1/4" Reducer Sleeve	Black Powder Coat	300	3,000	3.5	532 (Y)
RTA252	2-1/2" to 2" Reducer Sleeve	Zinc Plated	Does not change capacity		3.25	532 (Y)
NEW RTA302	3" to 2" Reducer Sleeve	Black Powder Coat	Does not change capacity		5.14	532 (Y)



Receiver Tubes & Adapters

Hitch Receiver Extensions



1804005

- Extend your receiver by 7", 12", or 18"
- Cast steel collar
- Accepts all 2" hitch accessories
- Black powder coat finish
- 5/8" hitch pin hole

Part No.	Extension/ Length	M.G.T.W. (lbs.)	Wt. (lbs.)	Cat.
1804003	7"	Reduces Hitch Capacity by 1/3	17.7	542 (N)
1804005	12"	Reduces Hitch Capacity by 1/3	17.7	542 (N)
1804007	18"	Reduces Hitch Capacity by 1/3	23.6	542 (N)

RV Bumper Trailer Hitch



- 2" Receiver opening
- Mounts to 4" square tube bumper of RV
- Zinc plated hardware included
- Class 2
- Easy to install
- Assembly required

Part No.	Description	M.V.L. (lbs.)	M.G.T.W. (lbs.)	Wt. (lbs.)	Cat.
1804060	Universal Receiver Hitch	350	3,500	9.5	532 (Y)

Hitch Receiver Extensions with Step



1804015

- Extend your receiver by 12" or 18"
- 17" x 6" step plate with diamond tread finish
- Cast steel collar
- Accepts all 2" hitch accessories
- Black powder coat finish
- 5/8" hitch pin hole

Part No.	Extension/ Length	M.G.T.W. (lbs.)	Wt. (lbs.)	Cat.
1804015	12"	Reduces Hitch Capacity by 1/3	21	542 (N)
1804017	18"	Reduces Hitch Capacity by 1/3	27	542 (N)

RV Bumper Receiver Adapter



- Fits standard 4" & 4-1/2" square RV bumpers
- Zinc plated hardware included
- Ideal for bike carriers & other accessories
- Accepts 2" tubes
- Assembly required

Part No.	Description	Wt. (lbs.)	Cat.
RVA24	RV Bumper Receiver Hitch (Not For Towing or Decorative Aluminum Bumper Covers)	7.0	532 (Y)

Step Bumper Hitch



- Fits most full sized trucks with step bumpers
- Accepts many 2" square ball mounts or accessories
- Black powder coat finish

Part No.	Description	M.V.L. (lbs.)	M.G.T.W. (lbs.)	Wt. (lbs.)	Cat.
SBH2	Step Bumper Hitch	350	3,500	6.25	532 (Y)

3-Point Tractor Hitch Receiver



- 2" Receiver opening
- Fits common 3-point tractor hitches
- (2) 7/8" pins & (1) 5/8" hitch pin included
- Easy to install

Part No.	Description	Wt. (lbs.)	Cat.
3005345	3-Point Receiver Hitch Assembly	45.0	532 (Y)

1-1/4" Ball Mounts



1803100CR



1803105



1803110

- Fits 1-1/4" receiver tubes
- Solid shank
- Black powder coat finish
- Tongue accepts 3/4" diameter shank towing balls

Part No.	Description	Shank Size	Length	Max Drop	Rise	M.V.L. (lbs.)	M.G.T.W. (lbs.)	Wt. (lbs.)	Cat.
1803100CR	Basic, Fixed Ball Mount	1-1/4"	9"	1-1/4"	1-1/4"	300	3,500	5.85	536 (Y)
1803105	Ball Mount	1-1/4"	7"	2-1/2"	2"	300	3,500	4.15	536 (Y)
1803110	Ball Mount	1-1/4"	7"	4"	3-1/2"	300	3,500	5.50	536 (Y)

2" Ball Mounts



1803005



1803006



1803007



1803010



1803013



1803015



1803016



1803017



1803017

- Straight & high-low tube style mounts
- Fits 2" receiver tubes
- Two-piece welded steel construction
- Black powder coat or chrome plated finish
- Tongue accepts 1" diameter shank towing balls

Part No.	Description	Shank Size	Finish	Length	Max Drop	Rise	M.V.L. (lbs.)	M.G.T.W. (lbs.)	Wt. (lbs.)	Cat.
1803005	Ball Mount	2"	Black	8"	2"	3/4"	750	7,500	6.85	536 (Y)
1803006	Ball Mount	2"	Chrome	8"	2"	3/4"	750	7,500	6.85	536 (Y)
1803007	Ball Mount	2"	Black	10"	2"	3/4"	750	7,500	5.75	536 (Y)
1803010	Ball Mount	2"	Black	8"	4"	2-3/4"	750	7,500	7.50	536 (Y)
1803013	Ball Mount	2"	Black	10"	4"	2-3/4"	750	7,500	7.0	536 (Y)
1803015	Ball Mount	2"	Black	10"	6"	4-3/4"	750	7,500	10.0	536 (Y)
1803016	Ball Mount	2"	Chrome	10"	6"	4-3/4"	750	7,500	10.0	536 (Y)
1803017	Ball Mount	2"	Black	10"	8"	6-3/4"	750	7,500	9.0	536 (Y)
1803019	Ball Mount, Solid Shank	2"	Black	10.28"	10-1/4"	9"	600	6,000	16.0	536 (Y)



Ball Mounts

Heavy Duty 2" Forged Ball Mounts



1803050



1803055

- Fits 2" receiver tubes
- Single piece, solid, forged steel
- Black powder coat finish
- Tongue accepts 1" & 1-1/4" diameter shank towing balls

Part No.	Description	Shank Size	Hole	Length	Max Drop	Rise	M.V.L. (lbs.)	M.G.T.W. (lbs.)	Wt. (lbs.)	Cat.
1803050	Heavy Duty Ball Mount	2"	1"	7.63"	2"	3/4"	2,000	20,000	12.0	536 (Y)
1803051	Heavy Duty Ball Mount	2"	1-1/4"	7.63"	2"	3/4"	2,000	20,000	12.0	536 (Y)
1803055	Heavy Duty Ball Mount	2"	1"	7.88"	4"	2-3/4"	2,000	20,000	12.8	536 (Y)
1803056	Heavy Duty Ball Mount	2"	1-1/4"	7.88"	4"	2-3/4"	2,000	20,000	12.8	536 (Y)
1803058	Heavy Duty Ball Mount	2"	1"	9.37"	6"	4-3/4"	1,700	17,000	16.0	536 (Y)
1803059	Heavy Duty Ball Mount	2"	1-1/4"	9.37"	6"	4-3/4"	1,700	17,000	16.0	536 (Y)

Heavy Duty 2-1/2" Ball Mounts



1803405



1803410

- Fits 2-1/2" receiver tubes
- Two-piece welded steel construction
- Black powder coat finish
- Tongue accepts 1-1/4" diameter shank towing balls

Part No.	Description	Shank Size	Length	Max Drop	Rise	M.V.L. (lbs.)	M.G.T.W. (lbs.)	Wt. (lbs.)	Cat.
1803405	Ball Mount	2-1/2"	10"	3"	1-1/2"	1,200	12,000	11.85	536 (Y)
1803410	Ball Mount	2-1/2"	10"	5"	3-1/2"	1,200	12,000	14.50	536 (Y)
1803415	Ball Mount	2-1/2"	10"	7-3/4"	6-1/4"	1,500	15,000	15.78	536 (Y)

Heavy Duty 2-1/2" Forged Ball Mounts



1803075



1803076

- Fits 2-1/2" receiver tubes
- Single piece, solid, forged steel
- Black powder coat finish
- Tongue accepts 1-1/4" diameter shank towing balls

Part No.	Description	Shank Size	Hole	Length	Max Drop	Rise	M.V.L. (lbs.)	M.G.T.W. (lbs.)	Wt. (lbs.)	Cat.
NEW 1803075	Heavy Duty Ball Mount	2-1/2"	1-1/4"	8.5"	2"	1/2"	2,700	20,000	16.16	536 (Y)
1803076	Heavy Duty Ball Mount	2-1/2"	1-1/4"	8.5"	4"	2.5"	2,700	20,000	16.95	536 (Y)

Clevis Ball Mount



1803060

- Use as clevis ball mount or ball mount
- Fits 2" receiver tubes
- Black powder coat finish
- Accepts 1" diameter shank towing balls
- 1803065 has solid shank

Part No.	Description	Shank Size	Length	M.V.L. (lbs.)	M.G.T.W. (lbs.)	Wt. (lbs.)	Cat.
1803060	Tubular Shank	2"	9-1/4"	600	6,000	11.9	536 (Y)
1803065	Solid Shank	2"	9-1/4"	800	8,000	17.4	536 (Y)

Adjustable Ball Mounts



- Fits 2" receiver tubes
- Welded steel construction
- Black powder coat finish
- Accepts 1" diameter shank towing balls

Part No.	Description	Shank Size	Max Drop	Max Lift	M.V.L. (lbs.)	M.G.T.W. (lbs.)	Wt. (lbs.)	Cat.
1803090	4-Position, Tubular Shank	2"	11"	9-3/4"	600	6,000	20	536 (Y)
861090	4-Position, Tubular Shank	2"	11"	9-3/4"	600	6,000	20	536 (Y)
1803095	4-Position, Solid Shank	2"	11"	9-3/4"	1,000	10,000	32	536 (Y)
1803093	3-Position, Tubular Shank	2"	8"	6-3/4"	600	6,000	14.89	536 (Y)

Ball Mount Kits



- **Ball mount kits sold in 3-packs only**
- Kit includes ball mount assembled with ball & hitch pin
- Ball mounts fits 2" receiver tubes
- Black powder coat or chrome plated ball mounts
- Two-piece welded steel construction

Part No.	Description	Hitch Pin Type	Shank Size	Ball Size	Max Drop	M.V.L. (lbs.)	M.G.T.W. (lbs.)	Wt. (lbs.)	Cat.
1803306	Chrome Ball Mount Kit	Cotter	2"	2"	2"	500	5,000	10	536 (Y)
1803306LP	Chrome Ball Mount Kit	Locking	2"	2"	2"	500	5,000	11.7	536 (Y)
1803307	Black Ball Mount Kit	Cotter	2"	2"	2"	500	5,000	10	536 (Y)
1803308	Black Ball Mount Kit	Cotter	2"	2-5/16"	2"	600	6,000	10	536 (Y)
1803312	Black Ball Mount Kit	Cotter	2"	1-7/8"	4"	600	6,000	12	536 (Y)
1803313	Black Ball Mount Kit	Cotter	2"	2"	4"	500	5,000	12	536 (Y)
1803314	Black Ball Mount Kit	Cotter	2"	2-5/16"	4"	600	6,000	12	536 (Y)

Chrome Hitch Balls



- Corrosion-resistant chrome plating
- Individually packaged

Part No.	Ball Size	Shank Size	Shank Length	M.G.T.W. (lbs.)	Wt. (lbs.)	Cat.
1802015	1-7/8"	3/4"	2-1/8"	3,500	1.80	545 (Y)
1802020	1-7/8"	1"	2-1/8"	5,000	2.25	545 (Y)
1802005	2"	1"	2-1/8"	5,000	2.50	545 (Y)
1802007	2"	1"	2-3/4"	10,000	2.50	545 (Y)
1802010	2"	3/4"	2-1/8"	3,500	2.10	545 (Y)
1802025	2-5/16"	1-1/4"	2-3/4"	10,000	4.20	545 (Y)
1802026	2-5/16"	1"	2-1/8"	7,500	3.20	545 (Y)
1802027	2-5/16"	1"	2-3/4"	10,000	3.20	545 (Y)

Hitch Ball

Bulk Hitch Balls with Black Finish



1802050

- Individually bagged
- Heat-treated black oxide finish for extra corrosion resistance
- 1" & 2" risers available

Part No.	Finish	Riser	Ball DIA.	Shank DIA.	Shank Length	M.G.T.W. (lbs.)	Wt. (lbs.)	Cat.
1802050	Plain	–	2-5/16"	1-1/4"	2-3/4"	30,000	4.10	545 (Y)
1802055	Plain	1"	2-5/16"	1-1/4"	2-3/4" (+1" riser)	30,000	4.81	545 (Y)
1802056	Plain	1"	2-5/16"	1-1/2"	2-3/4" (+1" riser)	30,000	4.85	545 (Y)
1802061	Plain	2"	2-5/16"	1-1/2"	2-3/4" (+2" riser)	30,000	5.60	545 (Y)

Bulk Hitch Balls with Chrome or Zinc Finish



1802103



1802175

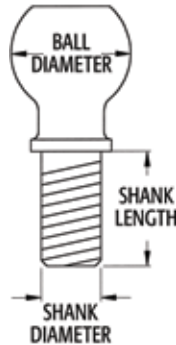

- Sold in multiples of 10 (10 balls per master carton)
- Individually labeled with part no., description & UPC barcode
- Available with chrome or zinc finish

Part No.	Finish / Description	Ball DIA.	Shank DIA.	Shank Length	M.G.T.W. (lbs.)	Wt. (lbs.)	Cat.
1802103	Chrome	1-7/8"	5/8"	1-3/4"	2,000	1.75	545 (Y)
1802105	Chrome	1-7/8"	3/4"	1-3/4"	2,000	1.80	545 (Y)
1802106	Zinc	1-7/8"	3/4"	1-3/4"	2,000	1.80	545 (Y)
1802108	Chrome	1-7/8"	3/4"	2-1/8"	3,500	1.80	545 (Y)
1802110	Chrome	1-7/8"	1"	2-1/8"	2,000	2.25	545 (Y)
1802111	Zinc	1-7/8"	1"	2-1/8"	2,000	2.25	545 (Y)
1802130	Chrome	2"	3/4"	1-3/4"	3,500	2.10	545 (Y)
1802131	Zinc	2"	3/4"	1-3/4"	3,500	2.10	545 (Y)
1802134	Chrome	2"	1"	2-1/8"	5,000	2.50	545 (Y)
1802135	Zinc	2"	1"	2-1/8"	5,000	2.50	545 (Y)
1802136	Chrome	2"	1"	2-3/4"	10,000	5.50	545 (Y)
1802148	Chrome	2"	1-1/4"	2-1/4"	7,500	3.75	545 (Y)
1802161	Chrome	2-5/16"	1"	2-1/8"	6,000	3.20	545 (Y)
1802162	Zinc	2-5/16"	1"	2-1/8"	6,000	3.20	545 (Y)
1802167	Chrome	2-5/16"	1-1/4"	2-1/2"	10,000	4.25	545 (Y)
1802168	Zinc	2-5/16"	1-1/4"	2-1/2"	10,000	4.25	545 (Y)
1802175	Chrome, with 2" riser	2-5/16"	1-1/4"	2-1/2" (+2" riser)	5,000	5.60	545 (Y)

Hitch Pin Assembly with Spring Clip





- 5/8" Zinc hitch pin with integral spring clip
- Fits 2" receivers
- Spring clip rotates to lock into place
- Retail packaging (50 per master carton)

Part No.	Description	Wt. (lbs.)	Cat.
 HP625SC	5/8" x 4.0" Clear Zinc Hitch Pin with Spring Clip	0.50	529 (Y)

Hitch Pin Assembly with Cotter



- Zinc plated with hairpin cotter
- Available in three sizes
- Replacement cotter pins also available
- Sold individually (bagged) or in a quick pack box (must order in quantities of 25)

Part No.	Description	Wt. (lbs.)	Cat.
HP545WC	1/2" x 3.2" Clear Zinc Hitch Pin Assembly: Fits 1-1/4" Receivers	0.30	529 (Y)
 HP545WCP	1/2" x 3.2" Clear Zinc Hitch Pin Assembly: Fits 1-1/4" Receivers	0.30	529 (Y)
HP6253WC	5/8" x 4.0" Clear Zinc Hitch Pin Assembly: Fits 2" Receivers	0.60	529 (Y)
 HP6253WCP	5/8" x 4.0" Clear Zinc Hitch Pin Assembly: Fits 2" Receivers	0.60	529 (Y)
HP6256WC	5/8" x 4.5" Yellow Zinc Heavy Duty Hitch Pin Assembly: Fits 1-1/2" Receivers	0.60	529 (Y)

Replacement Cotter Pin





- Zinc plated cotter pin
- Available in five sizes
- Replacement cotter pins

Part No.	Description	Wt. (lbs.)	Cat.
HP9	3/32" dia. Zinc Cotter Pin Replacement	0.01	520 (N)
HP10	1/8" dia. Zinc Cotter Pin Replacement	0.04	520 (N)
HP11	5/8" dia. Zinc Cotter Pin Replacement	0.05	520 (N)
HP12	5/32" dia. Zinc Cotter Pin Replacement	0.07	520 (N)
HP13	3/16" dia. Zinc Cotter Pin Replacement	0.07	520 (N)

Locking Hitch Pin





- Black powder coat finish with chrome plated pin
- Available in two sizes

Part No.	Description	Wt. (lbs.)	Cat.
 BLHP125	1/2" Locking Hitch Pin Assembly: Fits 1-1/4" Receivers	0.80	529 (Y)
 BLHP200	5/8" Locking Hitch Pin Assembly: Fits 2" or 2-1/2" Receivers	1.90	529 (Y)

Bone Style Locking Hitch Pin



- "Bone" style locking hitch pin assembly
- Chrome & black nickel finish available
- 5/8" dia. fits 2" receivers

Part No.	Description	Wt. (lbs.)	Cat.
 BLHP300	5/8" Bone Style Locking Hitch Pin Assembly with Chrome Finish	0.85	529 (Y)
 BLHP400	1/2"-5/8" Bone Style Locking Hitch Pin with Black Nickel Finish (Sleeved For 5/8")	0.75	529 (Y)

Safety Chains & Accessories

Class 2 & 3 Trailer Safety Chains



B93272SC

- Zinc plated
- Includes quick link connectors
- NOT FOR LIFTING

Part No.	Description	Chain DIA.	Chain Length	M.G.T.W. (lbs.)	Wt. (lbs.)	Cat.
B31648SC	2 - Quick Link Connectors	3/16"	48"	5,000	2.00	547 (N)
B93234SC	1 - Quick Link Connectors	9/32"	34"	5,000	2.08	544 (N)
B93248SC	2 - Quick Link Connectors	9/32"	48"	5,000	3.31	547 (N)
11215*	2 - Quick Link Connectors	9/32"	48"	5,000	3.31	547 (N)
B93272SC	2 - Quick Link Connectors	9/32"	72"	5,000	4.68	547 (N)
11220*	2 - Quick Link Connectors	9/32"	72"	5,000	4.68	547 (N)

*Packaged chains ship 5 per carton

Class 4 Trailer Safety Chain with Slip Hook



- Heavy duty zinc plated
- Includes 1 forged slip hook
- NOT FOR LIFTING

Part No.	Description	Chain DIA.	Chain Length	Coil	M.G.T.W. (lbs.)	Wt. (lbs.)	Cat.
B03822SC	1 - Forged Slip Hook	3/8"	22"	30 Proof	10,000	2.62	547 (N)

Class 4 Trailer Safety Chains with Slip Hook



B3835SC

- Heavy duty zinc plated
- Includes 1 clevis style slip hook
- NOT FOR LIFTING

Part No.	Description	Chain DIA.	Chain Length	Coil	M.G.T.W. (lbs.)	Wt. (lbs.)	Cat.
B03835SC	1 - Clevis Style Slip Hook	3/8"	35"	30 Proof	10,000	5.00	547 (N)
BSC3835	1 - Clevis Style Slip Hook	3/8"	35"	43 Proof	15,000	5.75	547 (N)
11275*	1 - Clevis Style Slip Hook	3/8"	35"	43 Proof	15,000	5.75	547 (N)
BSC3842	1 - Clevis Style Slip Hook	3/8"	42"	43 Proof	15,000	5.50	547 (N)

*Packaged chains ship 5 per carton

PROPER SAFETY CHAIN USE

Safety Chains act as the final connection between the towing vehicle and the trailer, in the event there is a failure in the towing hitch and/or the coupler.

Use one or two safety chains set to a length that will allow for the turning radius of the vehicle but will not drag on the ground when in operation. The safety chains must have a "holding" capacity of at least the total weight of the trailer and contents.

When applying the safety chain hook up, cross the chain(s) under the trailer tongue to ensure that the tongue will not drop to the ground in the event of a failure.

For full SAE safety chain specifications, refer to SAE J684 specifications and standards.

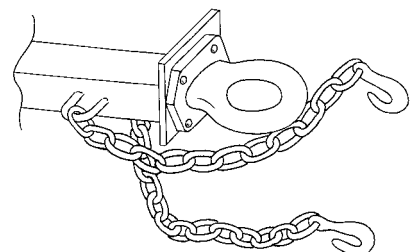

Weld-On Safety Chain Retainer



- Forged steel
- Removable pin
- Easier chain replacement
- No masking chains when painting

Part No.	Description	Wt. (lbs.)	Cat.
5471000	Safety Chain Retainer, For 5/16" Chain, 10K lbs MAX	0.73	518 (N)
5471001	Safety Chain Retainer, For 3/8" Chain, 25K lbs MAX	1.06	518 (N)

Cruciform Chain Bracket



- Bracket welds to bumper or hitch plate
- Insert safety chain through bracket & twist 1/4" turn for extra security

Part No.	Description	Wt. (lbs.)	Cat.
SC450C	4" x 5-1/2" x 1/2" Thick Steel Tubing	9.02	547 (N)

Safety Chain Clip



- Steel rod chain clip
- Secure chains to trailer frames

Part No.	Description	Wt. (lbs.)	Cat.
SC38B	3/8" dia. Safety Chain Clip	0.15	547 (N)
SC44B	7/16" dia. Safety Chain Clip	0.19	547 (N)
SC50B	1/2" dia. Safety Chain Clip	0.36	547 (N)
SC58B	5/8" dia. Safety Chain Clip	0.90	547 (N)

Double Clevis Link



- Drop forged
- Heat treated
- Clear Zinc plated

Part No.	Chain Size	Pin Diameter	W.L.L. (lbs.)	Wt. (lbs.)	Cat.
B2409C	3/8"	1/2"	5,400	0.75	710 (N)

Quick Link Connector



- 3/8" diameter
- Zinc plated
- Ideal for connecting chain, cable, wire or rope
- Not for lifting

Part No.	Description	W.L.L. (lbs.)	Wt. (lbs.)	Cat.
7350038	3/8" dia. Quick Link Connector	2,650	0.25	700 (N)



Weight Distributing Hitch

- Increased ride stability
- Improved control
- Improved braking & steering
- Raised hitch platform for additional trailer coupler clearance
- Dual sway control capability
- Black powder coat finish



Part No.	Description	G.V.W.R.	Vertical Rating (lbs.)	Wt. (lbs.)	Cat.
5421012	Weight Distributing Hitch, Trunnion Bar	12,000	1,200	89.00	542 (N)

Sway Control Kit

- Reduces sway from windy conditions or passing vehicles
- Comes complete with slide bar, crank handle, chrome ball, spring clips, friction plate & mount reinforcement plate
- Detaches quickly for storage
- Installation hardware included
- Black powder coat finish



Part No.	Description	Wt. (lbs.)	Cat.
5431000	Friction Sway Control	15.10	543 (N)

Receiver Mounted Tow Hook

- Straight pattern
- Fits 2" receiver tube
- Black powder coat finish



Part No.	Description	Capacity	Wt. (lbs.)	Cat.
RM10H	Receiver Mount Tow Hook	10,000	4.3	528 (N)

Forged Receiver Mounted Tow Hook

- Straight pattern
- Fits 2" receiver tube
- Black powder coat finish



Part No.	Description	Capacity	Wt. (lbs.)	Cat.
RM12H	Forged Receiver Mount Tow Hook	12,000	9.0	528 (N)

Forged Receiver Mount Tow Eye

- Straight pattern
- Fits 2" receiver tube
- Black powder coat finish



Part No.	Description	Capacity	Wt. (lbs.)	Cat.
RM1225E	Forged Receiver Mount Tow Eye	12,000	9.2	528 (N)

Forged Light Duty Towing Hooks



- Universal pattern
- Drop forged steel
- Black powder coat finish
- Shipped in pairs

Part No.	Description	W.L.L. (Per Hook, lbs.)	Wt. /Pr. (lbs.)	Cat.
B2799B	Black Powder Coated Towing Hooks	10,000	3.5	528 (N)
B2799BKT	Black Powder Coated Towing Hooks with Safety Clip & Bolt Kit	10,000	3.7	528 (N)

Weld-On Heavy Duty Hooks



- Forged steel, weld-on
- Grade 43

Part No.	Description	W.L.L. (Per Hook, lbs.)	Wt./Pr. (lbs.)	Cat.
B2408W	5/16" Weld-On Hook	3,900	0.44	700 (N)
B2408W375	3/8" Weld-On Hook	5,400	0.87	700 (N)
B2408W50	1/2" Weld-On Hook	9,200	1.72	700 (N)

Weld-On Heavy Duty Hooks



- Forged steel, weld-on
- Grade 70

Part No.	Description	W.L.L. (Per Hook, lbs.)	Wt./Pr. (lbs.)	Cat.
B2409W375	3/8" Weld-On Hook	6,600	1.0	700 (N)

Heavy Duty Towing Shackle



- Straight pattern
- Shipped individually
- Drop forged
- Black powder coat finish

Part No.	Description	W.L.L. (Per Hook, lbs.)	Wt. (lbs.)	Cat.
B0681	Black Finish Towing Shackle	18,000	9.7	524 (N)



Towing Hooks

Forged Towing Hook Pairs



Left Hand

Right Hand

- Shipped in pairs of right and left hand patterns
- Available in black powder coat, chrome plated or plain finish

Part No.	Description	W.L.L. (Power Hook, lbs.)	Hole Spacing (center to center)		Hole Size	Wt./Pr. (lbs.)	Cat.
			Vertical	Horizontal			
B2800A	Plain Finish Towing Hooks	13,500	4.25	-	0.78	9.4	528 (N)
B2800AB	Black Powder Coated Towing Hooks	13,500	4.25	-	0.79	9.4	528 (N)
B2800AC	Chrome Plated Towing Hooks	13,500	4.25	-	0.80/0.66	9.4	528 (N)

Forged Heavy Duty Towing Hook Pairs



Left Hand

Right Hand

- Shipped in pairs of right and left hand patterns
- Plain finish

Part No.	Description	W.L.L. (Per Hook, lbs.)	Hole Spacing (center to center)		Hole Size	Wt./Pr. (lbs.)	Cat.
			Vertical	Horizontal			
B2801A	2-Hole Plain Finish Towing Hooks	44,600	4.19	-	0.67/0.79	15.5	528 (N)

3 Hole Heavy Duty Towing Hook Pair



Left Hand

Right Hand

- Shipped in pairs of right and left hand patterns
- Drop forged
- Plain finish

Part No.	Description	W.L.L. (Per Hook, lbs.)	Hole Spacing (center to center)		Hole Size	Wt./Pr. (lbs.)	Cat.
			Vertical	Horizontal			
B2801C	3-Hole Plain Finish Towing Hooks	44,500	4.50	2.75	0.68	10.0	528 (N)

Bolt-On Heavy Duty Towing Hook



- Straight pattern
- Shipped individually
- Drop forged
- Black powder coat finish

Part No.	Description	W.L.L. (Per Hook, lbs.)	Hole Spacing (center to center)		Hole Size	Wt./Pr. (lbs.)	Cat.
			Vertical	Horizontal			
B076A	3-Hole Black Finish Towing Hook	20,000	2.50	2.81	1.25	4.0	528 (N)

Straight Tongue Couplers

- 2", 2-1/2" or 3" channel
- Can be bolted or welded to trailer frame
- Primed options do not have mounting holes



0091050Z



0091061

Part No.	Ball Diameter	Finish	Channel Width	M.G.T.W. (lbs.)	Class	Wt. (lbs.)	Cat.
0091050	1-7/8"	Primer	2"	2,000	1	2.56	534 (N)
0091050Z	1-7/8"	Zinc Plated, Yellow	2"	2,000	1	2.56	534 (N)
0091052	1-7/8"	Zinc Plated, Clear	2-1/2"	2,000	1	2.90	534 (N)
0091055	1-7/8"	Primer	3"	2,000	1	2.66	534 (N)
0091058	2"	Primer	2"	3,500	2	4.0	534 (N)
0091060	2"	Primer	2-1/2"	3,500	2	4.38	534 (N)
0091060Z	2"	Zinc Plated, Clear	2-1/2"	3,500	2	4.38	534 (N)
0091061	2"	Primer	2-1/2"	3,500	2	4.38	534 (N)
0091065	2"	Primer	3"	3,500	2	4.50	534 (N)

Heavy Duty Straight Tongue Couplers



0091562

- Auto engage latch
- Easy one hand operation
- 3" channel welded to coupler
- Cast steel coupler

Part No.	Ball Diameter	Finish	Channel Width	M.G.T.W. (lbs.)	Class	Wt. (lbs.)	Cat.
0091560	2"	Zinc Plated, Clear	3"	10,000	4	15.0	543 (N)
0091562	2-5/16"	Zinc Plated, Clear	3"	15,000	4	15.0	543 (N)

Comparison Chart for Couplers

BUYERS	ATWOOD®	DUTTON-LAINSON®	FULTON®	SHELBY®
0091050	—	940P-1	11200	5128
0091055	—	970P-1	11300	5131
0091058	—	982P-2	22250	5111
0091060	80051	985P-2	22300	5135

Buyers Products is not authorized by nor affiliated with the manufacturer Atwood®, Dutton-Lainson®, Fulton®, or Shelby® products. This information is made available for the convenience of our customers and is not meant to indicate that the product is shipped to/from above companies.



A-Frame / Gooseneck Couplers

A-Frame Trailer Couplers



0091091

- 50° A-Frame design
- Predrilled for round jack mounting

Part No.	Description	M.G.T.W. (lbs.)	Class	Wt. (lbs.)	Cat.
0091091	A-Frame Coupler, 2" Ball	5,000	3	6.70	534 (N)
0091097	A-Frame Coupler, 2-5/16" Ball	10,000	4	8.38	534 (N)

Heavy Duty A-Frame Trailer Coupler



- Auto engage latch
- Easy one hand operation
- 50° A-Frame design
- Predrilled for round jack mounting
- Cast steel with black powder coat finish

Part No.	Description	M.G.T.W. (lbs.)	Class	Wt. (lbs.)	Cat.
0091595	2-5/16" Black Cast Coupler	15,000	4	25.0	543 (N)

Coupler Latch Lock



- 1/4" Diameter steel pin x 3/4" adjustable travel
- Zinc plated solid cast metal
- Includes 2 keys
- Secures trailer on & off truck

Part No.	Description	Wt. (lbs.)	Cat.
BCL500	1/4" Pin x 3/4" Span	0.40	529 (Y)

Gooseneck Coupler



- Cast steel design
- Fits 2-5/16" towing ball
- Used with 4" or 4-1/2" round or square pipe
- Grade 8 hardware included
- Tested to SAE J2638

Part No.	Description	M.V.L. (lbs.)	M.G.T.W. (lbs.)	Wt. (lbs.)	Cat.
1808010	Gooseneck Coupler	N/A	30,000	12.5	546 (N)

Cast Couplers

- Heavy duty cast steel construction
- Auto-engage latch
- Easy one-hand operation
- Can be pinned open for ease of coupling

Cast Coupler with No Channel



0091540



0091600

Part No.	Ball Diameter	Finish	M.G.T.W. (lbs.)	Wt. (lbs.)	Cat.
0091540	2"	Plain	10,000	13.9	543 (N)
0091550	2-5/16"	Plain	15,000	13.0	543 (N)
NEW 0091600	2-5/16"	Black Powder Coat	25,000	16.22	543 (N)

Cast Coupler Assembly with 3-Position Channel



0091553

- Plain finish
- Fasteners included

Part No.	Description	M.G.T.W. (lbs.)	Wt. (lbs.)	Cat.
0091543	2" Assembly with 3 Position Channel	10,000	22.4	543 (N)
0091553	2-5/16" Assembly with 3 Position Channel	15,000	22.0	543 (N)

Cast Coupler Assembly with 5-Position Channel



0091555

- Plain finish
- Fasteners included

Part No.	Description	M.G.T.W. (lbs.)	Wt. (lbs.)	Cat.
0091545	2" Assembly with 5 Position Channel	10,000	27.2	543 (N)
0091555	2-5/16" Assembly with 5 Position Channel	15,000	28.0	543 (N)

- Multiple mounting configurations available: heavy duty 3-position or 5-position channel, bolt-on, one-piece channel
- Order complete assembly or individual components
- 3" coupler channels, 2" on center mounting holes

One Piece Cast Coupler



- 4-1/2" Sq. hole pattern, to suit 5/8" bolt
- Plain finish

Part No.	Ball Diameter	M.G.T.W. (lbs.)	Wt. (lbs.)	Cat.
0091558	2-5/16"	18,000	12.0	543 (N)

3-Position Channel & 5-Position Channel

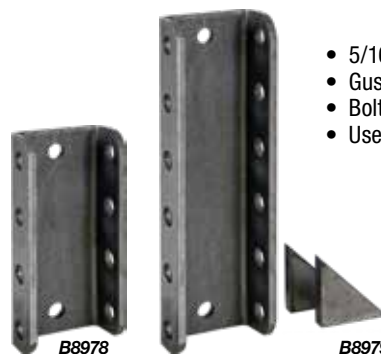

- 5/16" formed steel
- Gussets included with B8979
- Bolt and nut kit sold separately
- Used with 0091540, 0091550

Part No.	Description	Wt. (lbs.)	Cat.
B8978	3-Position Channel Only	9.06	527 (N)
B8979	5-Position Channel with Weld Gussets	15.0	543 (N)
B9020	Bolt & Nut Kit (2 each) 5/8-11 x 4-1/2 GR 8	1.0	543 (N)

Heavy Duty 3-Position Channel & 5-Position Channel



- 1/2" Formed steel
- Gussets included with B8979
- Bolt and Nut Kit sold separately
- Used with 0091550, 0091600

Part No.	Description	Wt. (lbs.)	Cat.
B9909	HD 3-Position Channel with Weld Gussets	9.06	527 (N)
B9912	HD 5-Position Channel with Weld Gussets	15.0	543 (N)
B99121	HD 5-Position Channel Only	15.0	543 (N)
B9021	Bolt & Nut Kit (2 each) 5/8-11 x 5 GR 8	1.0	543 (N)



Cast Eye Assemblies

6-Ton Adjustable Eye Assembly



B18128

- Ductile cast iron eye
- Formed 3" steel channel
- 3" I.D. eye
- 1-9/16" eye section
- 2,000 lb M.V.L.
- Fasteners included
- Gussets included with B18135

Part No.	Description	Material	M.G.T.W. (lbs.)	Wt. (lbs.)	Cat.
B18128	3 Position	Ductile Iron	12,000	13.9	543 (N)
10066	3 Position	Ductile Iron	12,000	13.0	543 (N)
B18135	5 Position	Ductile Iron	12,000	16.22	543 (N)

7-Ton Heavy Duty Adjustable Eye Assembly



- Ductile cast iron eye
- Formed 3" steel channel
- 3" I.D. eye
- 1-9/16" eye section
- 2,000 lb M.V.L.
- Fasteners and gussets included

Part No.	Description	Material	M.G.T.W. (lbs.)	Wt. (lbs.)	Cat.
B20135	5 Position	Cast Iron	14,000	24.5	543 (N)

10-Ton Heavy Duty Adjustable Eye Assembly

- Forged steel eye
- Heavy duty Formed 3" steel channel
- 3" I.D. eye
- 1-9/16" eye section
- 2,000 lb M.V.L.
- Fasteners and gussets included



B20143



B20145

Part No.	Description	Material	M.G.T.W. (lbs.)	Wt. (lbs.)	Cat.
B20143	3 Position	Forged Steel	20,000	21.5	543 (N)
B20145	5 Position	Forged Steel	20,000	25.5	543 (N)

Cast Tow Eye



B16137

- Ductile cast iron eye
- 3" I.D. eye
- 1-9/16" eye section
- 2,000 lb M.V.L.

Part No.	Finish	M.G.T.W. (lbs.)	Wt. (lbs.)	Cat.
B16137	Plain	14,000	11.0	543 (N)
B16137BK	Black Powder Coat	14,000	11.0	543 (N)
B16137Z	Zinc Plated	14,000	11.0	543 (N)

Forged Cast Tow Eye



B16140

- Forged steel eye
- 3" I.D. eye
- 1-9/16" eye section

Part No.	Finish	M.V.L. (lbs.)	M.G.T.W. (lbs.)	Wt. (lbs.)	Cat.
B16140	Plain	2,000	20,000	12.0	543 (N)
B16140Z	Zinc	2,000	20,000	12.0	543 (N)
B16145	Plain	3,000	25,000	12.81	543 (N)

3-Position Channel & 5-Position Channel

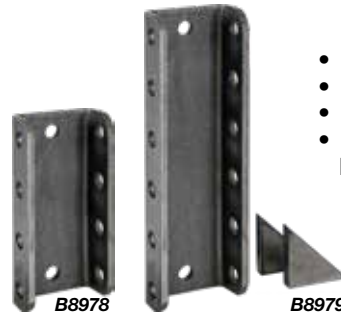

- 5/16" Formed steel
- Gussets included with B8979
- Bolt and Nut Kit sold separately
- Used with B18128, B18135, B16137

Part No.	Description	Wt. (lbs.)	Cat.
B8978	3-Position Channel Only	9.06	527 (N)
B8979	5-Position Channel with Weld Gussets	15.0	543 (N)
B9020	Bolt & Nut Kit (2 each) 5/8-11 x 4-1/2 GR 8	1.0	543 (N)

Heavy Duty 3-Position Channel & 5-Position Channel

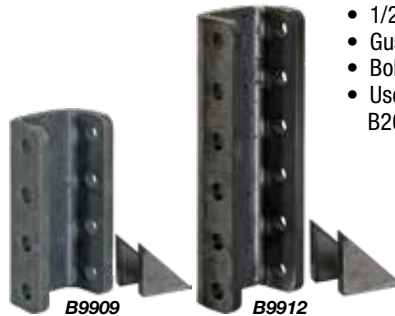

- 1/2" Formed steel
- Gussets included with B8979
- Bolt and Nut Kit sold separately
- Used with B20135, B20143, B20145, B1640

Part No.	Description	Wt. (lbs.)	Cat.
B9909	HD 3-Position Channel with Weld Gussets	9.06	527 (N)
B9912	HD 5-Position Channel with Weld Gussets	15.0	543 (N)
B99121	HD 5-Position Channel Only	15.0	543 (N)
B9021	Bolt & Nut Kit (2 each) 5/8-11 x 5 GR 8	1.0	543 (N)

2 Axle Proportional Brake Controller



- Recommended for light-duty trailers with 2 or 4 electronic brakes
- Time-based electronic trailer brake controller
- Quick connect wire plug
- Safest time-based controller available
- Includes mounting bracket and hardware
- 3-Year warranty

3 Axle Proportional Brake Controller



- Recommended for medium/heavy duty trailers with 2, 4 or 6 electronic trailer brakes
- Proportional electronic trailer brake controller
- Faster/smoothier stopping performance
- Quick connect wire plug
- Automatic and manual trailer braking
- Includes mounting bracket and hardware
- 5-Year warranty

Part No.	Description	Wt. (lbs.)	Cat.
 BC2A	2 Axle Brake Controller	0.6	542 (N)

Part No.	Description	Wt. (lbs.)	Cat.
 BC3AP	3 Axle Proportional Brake Controller	0.6	542 (N)

4 Axle Digital Proportional Brake Controller



- Recommended for medium/heavy duty trailers with 2, 4, 6 or 8 electronic brakes
- Faster/smoothier, proportional braking
- Digital controller
- Adjustable turn-on power
- Built-in diagnostics display
- Quick connect wire plug
- Automatic and manual trailer braking
- Includes mounting bracket and hardware
- Lifetime warranty

Part No.	Description	Wt. (lbs.)	Cat.
 BC4APD	4 Axle Proportional Brake Controller, Digital	0.7	542 (N)

Brake Control Wiring Harness







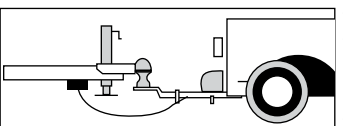





- Electric brake controller wiring connector for vehicles with factory tow package wiring
- Simple plug-in installation, eliminates errors
- No cutting, splicing or taping
- Simple quick connect 3' leads, saves on installation time
- Fits Dodge, Ford, Chevy/GMC*

Breakaway Switch Kit



- 48" Plastic coated high-strength cable
- Zinc plated mounting bracket: bolt-on or weld-on
- 6-24 Volt
- Switch activates electric brakes if emergency cable pulls out
- Easy to use spring clip
- Not a substitute for safety chains
- Retail clamshell
- Compares to Redneck™* 2010 (420000), & Tekonsha™* Model 2010

Part No.	Description	Wt. (lbs.)	Cat.
 5422010	Breakaway Switch, 12V with 48" Prewired Loop	0.41	542 (N)
5422012	Pin & Cable Replacement for 5422010 Breakaway Switch	0.10	542 (N)

Part No.	Year	Application*	Wt. (lbs.)	Cat.
 BCHD	'95-'11	Dodge/RAM Various Models	0.25	542 (N)
 BCHD1	'11-'16	Dodge/RAM Various Models	0.25	542 (N)
 BCHD2	'13-'14	Dodge/RAM 1500, 2500, 3500	0.25	542 (N)
 BCHF	'92-'15	Ford Various Models	0.25	542 (N)
 BCHF1	'05-'07	Ford Super Duty, E-350, E-450, F-250, F-350, F-450, F-550	0.35	542 (N)
 BCHF2	'08-'16	Ford Various Models	0.25	542 (N)
 BCHF3	2017+ 2018+	Ford Super Duty Ford F-150 Super Crew	0.25	542 (N)
 BCHGM03	'02-'07	Chevy/GMC Various Models	0.25	542 (N)
 BCHGM04	'14-'16	Chevy/GMC Various Models	0.25	542 (N)

*See buyersproducts.com for complete application guide

Trailer Connectors

2-Way Die-cast Zinc Trailer Connector



- **TC2002 / TC1012** (trailer end) **TC1002 / TC2012** (truck end)
- Die-cast zinc construction
- Round pins, split brass formed for positive contact
- Floating male pins for easy hook-up

Truck End Part No.	Trailer End Part No.	Description	Pin Style	Wt. (lbs.)	Cat.
TC1002	TC2002	2-Way Trailer Connector, Horizontal Pin Arrangement, Die-cast	Round	0.74 / 0.68	542 (N)
TC1012	TC2012	2-Way Trailer Connector, Vertical Pin Arrangement, Die-cast	Round	0.68 / 0.79	542 (N)

4-Way Die-Case Zinc Trailer Connector



- **TC1004** (truck end) **TC2004** (trailer end)
- Die-cast zinc construction
- Round pins, split brass formed for positive contact
- Floating male pins for easy hook-up

Truck End Part No.	Trailer End Part No.	Description	Pin Style	Wt. (lbs.)	Cat.
TC1004	TC2004	4-Way Trailer Connector, Metal	Round	0.33 / 0.16	542 (N)

6-Way Die-cast Zinc Trailer Connector



- **TC1006** (truck end) **TC2006** (trailer end)
- **TC2061** (trailer end)
- Die-cast zinc construction
- Round pins, split brass formed for positive contact
- Floating male pins for easy hook-up
- Cable cover spring (TC2061)

Truck End Part No.	Trailer End Part No.	Description	Pin Style	Wt. (lbs.)	Cat.
TC1006	TC2006	6-Way Trailer Connector, Metal	Round	0.34 / 0.16	542 (N)
	TC2061	6-Way Trailer Connector, Metal, with Cover Spring	Round	0.34 / 0.35	542 (N)

7-Way Die-cast Zinc Trailer Connector



- **TC1007** (truck end) **TC2007** (trailer end)
- Die-cast zinc construction, round pins
- Self-cleaning pressure contacts
- Plated contacts for ultimate weather and corrosion protection
- Built-in safety latch prevents damage from accidental drive-away
- Stainless steel weather cover spring
- Color-coded terminals to RV1 standards for proper hook-up

Truck End Part No.	Trailer End Part No.	Description	Pin Style	Wt. (lbs.)	Cat.
TC1007	TC2007	7-Way Trailer Connector	Round	0.63 / 0.75	542 (N)

7-Way Plastic Trailer Connector



- **TC1007P** (truck end) **TC2007P** (trailer end)
- Plastic 7 flat pins (RV-type)
- Plastic inserts keep out dirt and moisture
- Built-in safety latch prevents damage from accidental drive-away

Truck End Part No.	Trailer End Part No.	Description	Pin Style	Wt. (lbs.)	Cat.
TC1007P	TC2007P	7-Way Trailer Connector, Plastic	Flat	0.33 / 0.16	542 (N)

7-Way Stamped Metal Trailer Connector



- **TC1007Z** (truck end) **TC2007Z** (trailer end)
- Die-cast zinc construction
- Flat pins
- Spring-loaded door protects terminals when not in use

Truck End Part No.	Trailer End Part No.	Description	Pin Style	Wt. (lbs.)	Cat.
TC1007Z	TC2007Z	7-Way Trailer Connector, Zinc	Flat	0.49 / 0.27	542 (N)

7-Way Flat with 96" Prewired Cable



- **TC1967P** (truck end) **TC2967P** (trailer end)
- 7-Way Wire:
 - (2) 10 gauge wires: black & white
 - (1) 12 gauge wire: blue
 - (4) 14 gauge wires: brown, green, red, yellow
- 96" pre-wired cable

Truck End Part No.	Trailer End Part No.	Description	Pin Style	Wt. (lbs.)	Cat.
TC1967P	TC2967P	7-Way Flat with 96" Prewired Cable	Flat	2.35	542 (N)

NEW

Trailer Connector Adapters

6-Way Round Pin to 7-Way Flat Pin Adapter



- Prewired, 8"
- Compares to: Brophy™ #CRR67F & Pollak™ #12-725EP

Part No.	Description	Wt. (lbs.)	Cat.
TC1067P	6-Way Round to 7-Pin Flat RV Adapter	0.80	542 (N)

7-Way Flat Pin Trailer Connector



TC1770P



TC1771P

- Flat pins
- Plastic housing
- OEM style rear connector
- Built-in connection latch

Part No.	Description	Wt. (lbs.)	Cat.
TC1770P	7-Way Truck Receptacle	0.31	542 (N)
TC1770B	Bulk TC1770P without retail box	0.31	542 (N)
TC1771P	7-Way Truck Receptacle with Twist Lock	0.33	542 (N)

7-Way Flat Pin Dual-Plug Trailer Connector



- 7-way flat and 4 flat connections
- Prewired 10", 4 flat & pigtail ends
- Plastic housing
- Built-in connection latch
- RVI color-coded wiring terminals
- Mounting bracket and hardware included

Part No.	Description	Wt. (lbs.)	Cat.
TC1474P	7-Way Dual-Plug Trailer Connector, 10" prewire - 4 flat	1.15	542 (N)

7-Way and OEM Dual-Plug Trailer Connector



- 7-way flat and 4 flat connections
- Prewired 8" OEM style rear connector
- Plastic housing
- Built-in connection latch
- Mounting bracket and hardware included

Part No.	Description	Wt. (lbs.)	Cat.
TC1774P	7-Way Dual-Plug Trailer Connector, 8" prewire - OEM	1.15	542 (N)

6-Way Round Pin to 4-Flat Trailer Connector Adapter



Part No.	Description	Wt. (lbs.)	Cat.
TC2064P	6-Way Round to 4-Flat Adapter, Plastic	0.22	542 (N)

7-Way Round Pin to 4-Flat Trailer Connector Adapter



Part No.	Description	Wt. (lbs.)	Cat.
TC2074P	7-Way Round to 4-Flat Adapter, Plastic	0.18	542 (N)

7-Way Round Pin to 4-Flat Trailer Connector Adapter



Part No.	Description	Wt. (lbs.)	Cat.
NEW TC2274P	7-Way Round to 4-Flat Adapter, Plastic	0.18	542 (N)

7-Way Flat Pin to 4-Flat Trailer Connector Adapter



Part No.	Description	Wt. (lbs.)	Cat.
TC2074T	7-Way Round to 4-Flat Adapter with Dust Cap, Plastic, LED Tester	0.55	542 (N)

Trailer Connector Adapters

7-Way Flat Pin to 5-Way Trailer Connector Adapter



Front

Rear

Part No.	Description	Wt. (lbs.)	Cat.
TC2075P	7-Way Round to 5-Flat Round Adapter, Plastic	0.22	542 (N)

7-Way Flat Pin to 6-Way Round Pin Trailer Connector Adapter



Front

Rear

Part No.	Description	Wt. (lbs.)	Cat.
TC2076P	7-Way Flat to 6-Way Round Adapter, Plastic (center pin auxiliary power)	0.22	542 (N)

7-Way Round Pin to 7-Way Flat Pin Trailer Connector Adapter



Open

Part No.	Description	Wt. (lbs.)	Cat.
TC1077P	7-Way Round to 7-Way Flat, Plastic, Prewired 3' connection, Built-in Connection Latch	0.80	542 (N)

7-Way Trailer Connector Bracket



Part No.	Description	Wt. (lbs.)	Cat.
TC107	7-Way (Flat) Trailer Connector Bracket, Zinc	0.15	542 (N)

4-5-6-Way Trailer Connector Bracket



Part No.	Description	Wt. (lbs.)	Cat.
TC1456	4-5-6 Way Trailer Connector Bracket, Zinc	0.20	542 (N)

Rubber Boot for 4-5-6-Way Trailer Connector



Part No.	Description	Wt. (lbs.)	Cat.
TC1046B	Rubber Boot, fits 4-5-6 Way Connectors	0.10	542 (N)

Rubber Boot For 7-Way Trailer Connector



Part No.	Description	Wt. (lbs.)	Cat.
TC1007B	Rubber Boot, fits 7-Way Connectors	0.10	542 (N)

Vehicle Side Replacement Cable



Part No.	Description	Wt. (lbs.)	Cat.
TC1242	4-Flat Vehicle Side Replacement Cable with Dust Cap, Prewired 48" Cable,	0.19	542 (N)

Prewired Loop with 4-Way Flat Connector



Part No.	Description	Wt. (lbs.)	Cat.
TC1244	4-Way Flat with Cap, 48" Prewired Loop	0.25	542 (N)

Breakaway Switch



Part No.	Description	Wt. (lbs.)	Cat.
5422010	Break-Away Switch, Bolt or Weld-On, 48" Plastic Coated High-Strength Cable	0.41	542 (N)
5422011	5422010 in Bulk	0.41	542 (N)

Heavy Duty Tail Light Converter



Part No.	Description	Wt. (lbs.)	Cat.
5423203	Heavy Duty (6 Amp) 3-2 Solid State Tail Light Converter	0.41	542 (N)

Pin & Cable Replacement for Breakaway



Part No.	Description	Wt. (lbs.)	Cat.
5422012	Pin & Cable Replacement, used with 5422010	0.10	542 (N)

Jacks

12-Volt Electric Jack



- 48" long prewired (7-Pin RV Type) trailer connector power supply for quick, plug-in operation
- 5,000 lbs. breakaway capacity (assists hitch ball release)
- Hardened steel gears
- Full 24" stroke: (18" power + 6" manual drop leg extension)
- Oversized foot pad prevents divots
- Zinc plated foot is adjustable on 1-1/2" centers (detachable)
- Built-in leveling gauge
- LED night light
- Weather sealed switches
- Black powder coat finish
- 33" overall height
- 25A continuous, 28A max.
- 20A circuit breaker

Part No.	Description	Capacity (lbs.)	Travel	Wind	Wt. (lbs.)	Cat.
0093500	12 Volt DC powered with manual crank over-ride	3,500	24"/18"	Top	22.00	533 (N)

Swing-Away Marine Jack



- 14-3/4" retracted, 24-3/4" extended
- 14-3/4" mount height
- 6" wheel
- Bolt-on mounting bracket fits up to 3" x 5" trailer frame
- All mounting hardware included
- Zinc finish

Part No.	Description	Capacity (lbs.)	Travel	Wind	Wt. (lbs.)	Cat.
0091610	Swing-Away Marine Jack	1,000	10"	Side	14.00	533 (N)

Swivel Jack



0091205



0091220



3005528

Part No.	Description	Capacity (lbs.)	Travel	Wind	Wt. (lbs.)	Cat.
0091205	Top Wind Swivel Jack	2,000	10"	Top	11.14	533 (N)
0091215	Top Wind Swivel Jack	2,000	15"	Top	14.22	533 (N)
0091220	Side Wind Swivel Jack	5,000	10"	Side	13.26	533 (N)
3005528	Tube Trailer Jack Mounting Assembly				2.44	533 (N)

Top-Wind Jack with Swivel Mount



0091210

Part No.	Description	Capacity (lbs.)	Travel	Wind	Wt. (lbs.)	Cat.
0091210	Top Wind Swivel Jack	2,000	10"	Top	11.82	533 (N)
0091225	Top Wind Swivel Jack	2,000	15"	Top	14.88	533 (N)

Square Drop-Foot Jack



0091310



0091340

Part No.	Description	Capacity (lbs.)	Travel	Wind	Wt. (lbs.)	Cat.
0091310	2-1/2" Square Tube Jack, Top Wind	7,000	15"	Top	12.50	533 (N)
0091340	2-1/2" Square Tube Jack, Side Wind	7,000	15"	Side	12.50	533 (N)

A-Frame Jack



0091260 /
0091265



0091261 /
0091266



0091269

Part No.	Description	Capacity (lbs.)	Travel	Wind	Wt. (lbs.)	Cat.
0091260	A-Frame, Includes Support Foot	2,000	15"	Top	12.78	533 (N)
0091265	A-Frame, Includes Support Foot	5,000	15"	Top	12.84	533 (N)
0091261	A-Frame, Jack Only	2,000	15"	Top	11.44	533 (N)
0091266	A-Frame, Jack Only	5,000	15"	Top	11.44	533 (N)
0091269	A-Frame, Foot Only	-	-	-	1.78	533 (N)



Side-Pin Heavy Duty Square Jack



- 4" square jack
- Spring return with side pin
- Black powder coat finish

Part No.	Description	Capacity (lbs.)	Travel	Wind	Wt. (lbs.)	Cat.
0091410H	Side Pin Jack with Handle	10,000 Dynamic*	12" screw travel with 14" adj.	Side	64.40	533 (N)
0091410	Side Pin Jack, less Handle	10,000 Dynamic*	12" screw travel with 14" adj.	Side	61.00	533 (N)
0091405H	Handle for 0091410 & 0091415	—	—	—	3.40	533 (N)

Replacement handles come with mounting hardware.
*12,000 lbs. Static

Front-Pin Heavy Duty Square Jack



- 4" square jack
- Spring return with side pin
- Black powder coat finish

Part No.	Description	Capacity (lbs.)	Travel	Wind	Wt. (lbs.)	Cat.
0091415H	Front Pin Jack with Handle	10,000 Dynamic*	12" screw travel with 14" adj.	Side	64.40	533 (N)
0091415	Front Pin Jack, less Handle	10,000 Dynamic*	12" screw travel with 14" adj.	Side	61.00	533 (N)
0091405H	Handle for 0091410 & 0091415	—	—	—	3.40	533 (N)

Replacement handles come with mounting hardware.
*12,000 lbs. Static

LIGHTING

We've brought affordable LED lighting to the truck and trailer market. With more lighting choices than anyone else, we make it easy to light up your work vehicles.

ICON KEY

LIMITED W	Limited Lifetime Warranty
1-YEAR W	1 Year Warranty
5-YEAR W	5 Year Warranty
12 VOLTS	12 Volts
12-24 VOLTS	12-24 Volts
PC RATED	PC Rated
IP 65	IP65 Rated
IP 66	IP66 Rated
IP 67	IP67 Rated
IP 68	IP68 Rated
IP X6	IPX6 Rated
IP X8	IPX8 Rated
SAE J595 CLASS 1	SAE J595 Class 1
SAE J595 CLASS 2	SAE J595 Class 2
SAE J845 CLASS 1	SAE J845 Class 1
SAE J845 CLASS 2	SAE J845 Class 2
CA 13	CA13

Refer to page M1-M3 for more details

WORK LIGHTS

NEW Ultra Bright Articulating LED Flood & Spot Lights	C2
NEW Wide Angle 4" LED Combination Spot-Flood Light	C6
NEW Ultra Bright 6" LED Flood Light	C7
NEW Ultra Bright 6.5" LED Flood Light	C8

LED COMBINATION SPOT-FLOOD LIGHT BARS

C13

INTERIOR AND SPECIALTY WORK LIGHTS

C16

NEW 96"-132" Clear & Cool LED Light Strips	C16
NEW 18-48" LED Tube Lights	C16
NEW Strobe Controller	C16
Snow Plow Lights	C18

WARNING LIGHTS

C19

LIGHT BARS

C19

NEW 49" Fleet Series Light Bar	C22
NEW Fleet Series Drill-Free Light Bar Cab Mount	C25
NEW Ultra Thin Wide Angle 5" Strobe	C28
NEW Ultra Bright Narrow Profile 5" LED Strobe	C33
NEW Triple-Row 5.5" LED Strobe	C35
NEW Quad-Row 5" LED Strobe	C35
NEW Crush Resistant LED Strobe Kit	C36
NEW 6" Recessed LED Strobe	C38

BEACON STROBES

C39

NEW SAE J595 Class 1 Beacon	C39
NEW 5.5" Portable LED Beacon	C41
NEW Beacon Mounting Bracket Assortment	C43

DOT LIGHTS

C44

NEW 17" Slimline Stop/Turn/Tail LED Light	C49
NEW 4" Round Combination Stop/Turn/Tail & back Up LED Light	C51
NEW 6" Oval Combination Stop/Turn/Tail & Back Up LED Light	C52
NEW Box-Style LED Stop/Turn/Tail LED Light	C54
NEW 2-3/8" License/Utility Incandescent Light	C60

REFLECTORS AND CONSPICUITY TAPE

C61

LIGHT BOXES AND SPREADER LIGHT BAR KITS

C62



Round Lens

Ultra Bright 5" LED Articulating Flood Light

5-YEAR
W
12-24
VOLTS
IP 67

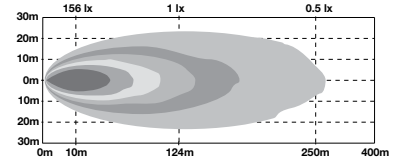
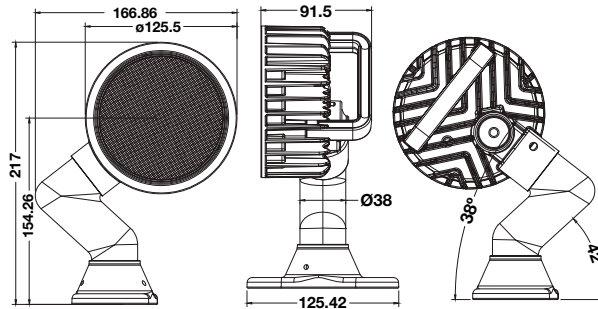

Part No.	Size	LED's	Amps	Lumens	Color	Base / Mount	Lead Length	Connection	Wt. (lbs.)	Cat.
NEW 1492145	5"	18	3	4500	Clear	8mm stud SST	36"	Blunt Cut	1.63	562 (N)

Ultra Bright 5" LED Articulating Spot Light

5-YEAR
W
12-24
VOLTS
IP 67

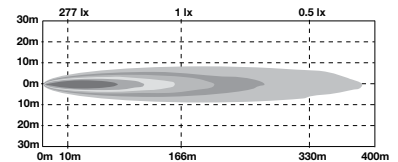
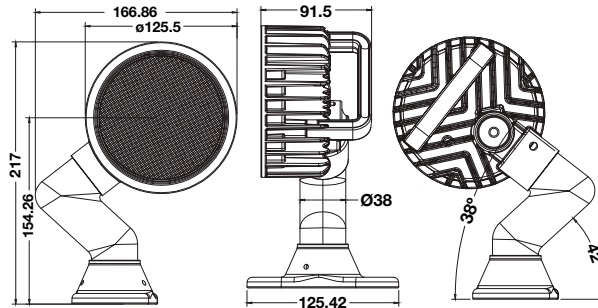

Part No.	Size	LED's	Amps	Lumens	Color	Base / Mount	Lead Length	Connection	Wt. (lbs.)	Cat.
NEW 1492146	5"	18	3	4500	Clear	8mm stud SST	36"	Blunt Cut	1.63	562 (N)

5" LED Articulating Flood Light

5-YEAR
W
12-24
VOLTS
IP 67

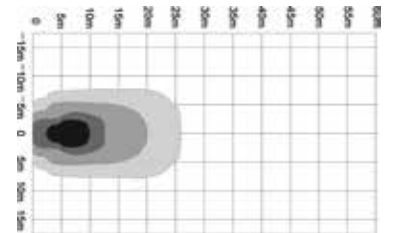
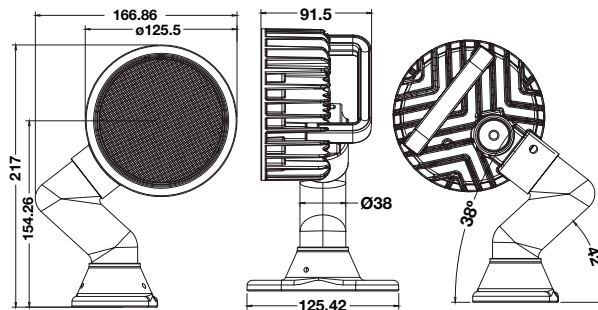

Part No.	Size	LED's	Amps	Lumens	Color	Base / Mount	Lead Length	Connection	Wt. (lbs.)	Cat.
NEW 1492125	5"	6	1.5	1350	Clear	8mm stud SST	36"	Blunt Cut		562 (N)

5" LED Articulating Spot Light

5-YEAR
W
12-24
VOLTS
IP 67

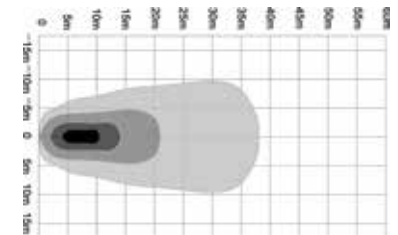
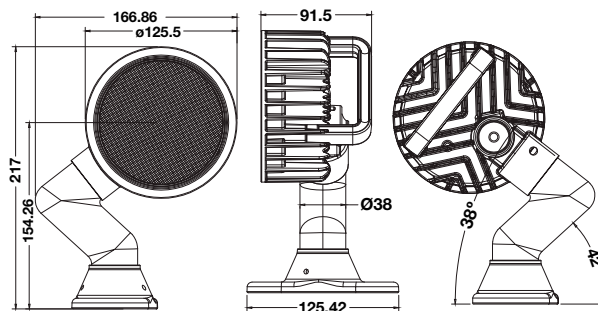

Part No.	Size	LED's	Amps	Lumens	Color	Base / Mount	Lead Length	Connection	Wt. (lbs.)	Cat.
NEW 1492126	5"	6	1.5	1350	Clear	8mm stud SST	36"	Blunt Cut		562 (N)

Ultra Bright 5" LED Flood Light

5-YEAR
W
12-24
VOLTS
IP
67

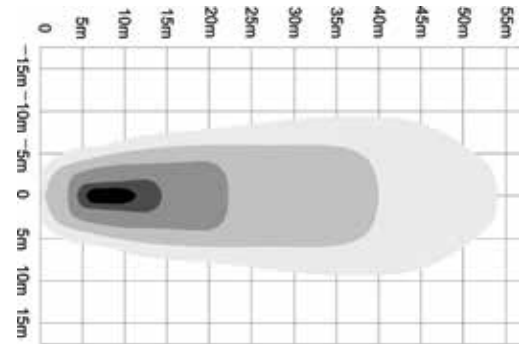
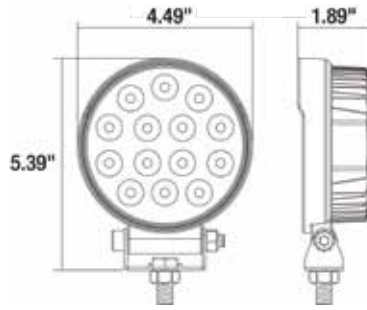

Part No.	Size	LED's	Amps	Lumens	Color	Base / Mount	Lead Length	Connection	Wt. (lbs.)	Cat.
1492127	5"	14	1.83	3780	Clear	10mm stud SST	18"	Blunt Cut	1.49	562 (N)

4" LED Flood Light

5-YEAR
W
12-24
VOLTS
IP
67

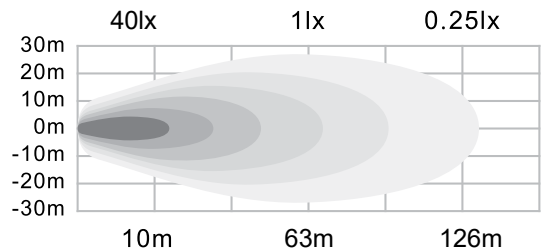
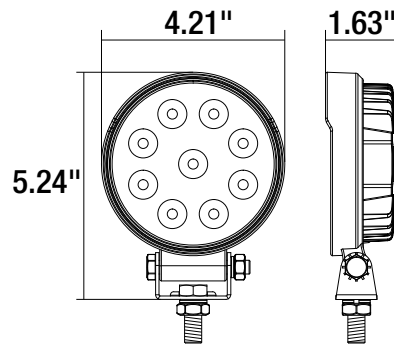

Part No.	Size	LED's	Amps	Lumens	Color	Base / Mount	Lead Length	Connection	Wt. (lbs.)	Cat.
1492114	4.21"	9	1.25	1710	Clear	8mm stud SST	18"	Blunt Cut	1.58	562 (N)

4" LED Magnetic Base Flood Light

5-YEAR
W
12-24
VOLTS
IP
67

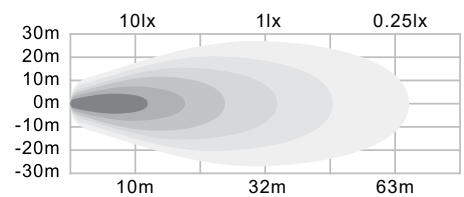
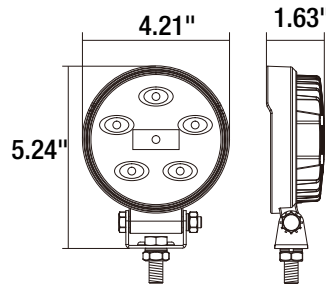

Part No.	Size	LED's	Amps	Lumens	Color	Base / Mount	Lead Length	Connection	Wt. (lbs.)	Cat.
1492130	4.6"	6	1.5	1140	Clear	Magnetic	30'	12V DC Adapter	2.53	562 (N)

Round Lens

4.5" LED Flood Light

5-YEAR
W
12-24
VOLTS
IP
67

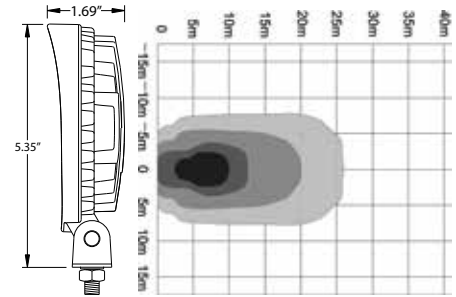
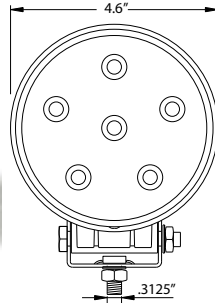

Part No.	Size	LED's	Amps	Lumens	Housing Color	Lens Color	Base / Mount	Lead Length	Connection	Wt. (lbs.)	Cat.
1492115	4.6"	6	1.5	1350	Black	Clear	8mm stud SST	36"	Blunt Cut	1.20	562 (N)
1492116	4.6"	6	1.5	1350	Black	Amber	8mm stud SST	36"	Blunt Cut	1.20	562 (N)
1493215	4.6"	6	1.5	1350	White	Clear	8mm stud SST	36"	Blunt Cut	1.20	562 (N)

4.5" LED Spot Light

5-YEAR
W
12-24
VOLTS
IP
67

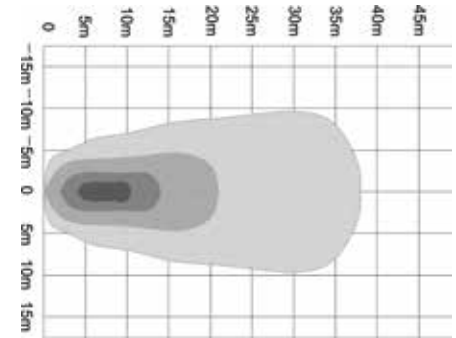
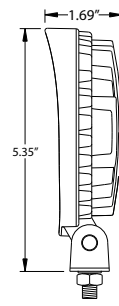
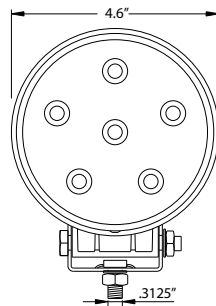

Part No.	Size	LED's	Amps	Lumens	Color	Base / Mount	Lead Length	Connection	Wt. (lbs.)	Cat.
1492215	4.6"	6	1.5	1350	Clear	8mm stud SST	36"	Blunt Cut	1.20	562 (N)

5" LED Sealed Rubber Flood Light

5-YEAR
W
12-24
VOLTS
IP
67

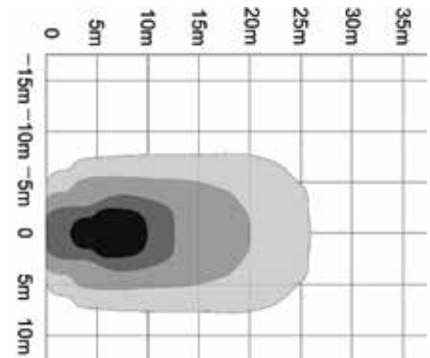
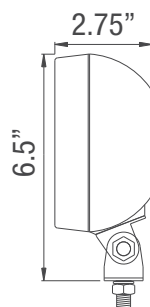
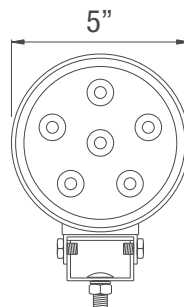

Part No.	Size	LED's	Amps	Lumens	Color	Base / Mount	Lead Length	Connection	Wt. (lbs.)	Cat.
1492112	5"	6	1.5	1350	Clear	8mm stud SST	36"	Blunt Cut	1.80	562 (N)

5" LED Sealed Rubber Flood Light

5-YEAR
W
12-24
VOLTS
IP
67



1492110



1492111

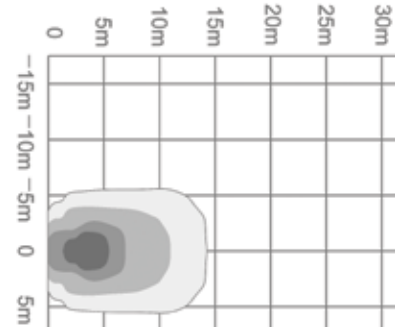
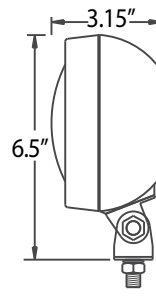
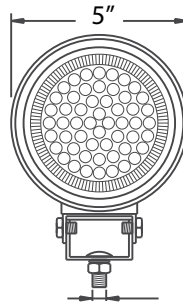

Part No.	Size	LED's	Amps	Lumens	Color	Base / Mount	Lead Length	Connection	Wt. (lbs.)	Cat.
1492110	5"	54	3	375	Clear	8mm stud SST	36"	Blunt Cut	1.63	562 (N)
1492111	5"	54	3	375	Amber	8mm stud SST	36"	Blunt Cut	1.63	562 (N)

5" Incandescent Sealed Rubber Flood Light

5-YEAR
W
12
VOLTS
IP
67

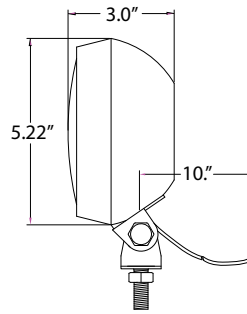
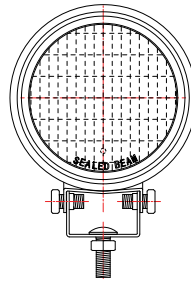

Part No.	Size	Amps	Watts	Color	Base / Mount	Lead Length	Connection	Std. Qty.	Wt. (lbs.)	Cat.
1492100	5"	2.92	35	Clear	Zinc	10"	Blunt Cut	1	2.64	562 (N)

5.5" LED Spot/Flood Light

5-YEAR
W
12-24
VOLTS
IP
67

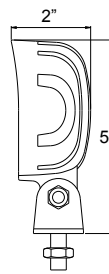
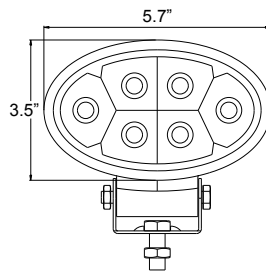

• Hybrid Beam Patterns: Spot Light for Distance and Flood Light For Close Up

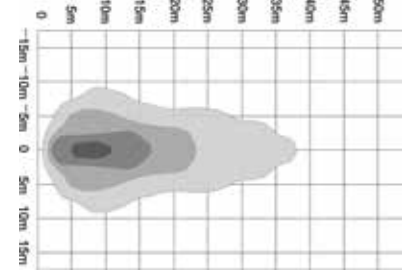

Part No.	Size	LED's	Amps	Lumens	Color	Base / Mount	Lead Length	Connection	Wt. (lbs.)	Cat.
1492113	5.70"	6	1.5	1350	Clear	8mm stud SST	36"	Blunt Cut	1.20	562 (N)

Work Light with Built-In Backup Camera



- Produces 1100 lumens of light
- Durable camera features a 976 (H) x 592 (V) pixel resolution
- Night vision capabilities and a wide 140° viewing angle to help capture everything going on even in low visibility situations

Part No.	Description	Cat.
NEW 8883110	Round Work Lamp Camera	888 (N)

Stainless Steel Mounts

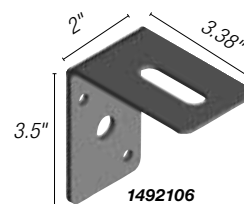

1492106

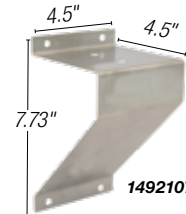

1492107

Part No.	Description	Wt. (lbs.)	Cat.
1492106	Stainless Steel Bracket	0.47	562 (N)
1492107	Stainless Steel Bracket	0.90	562 (N)

Square Lens

Ultra Bright 4" LED Flood Light

• Features TCS (temperature control system), automatically adjusts light for maximum power depending on temperature

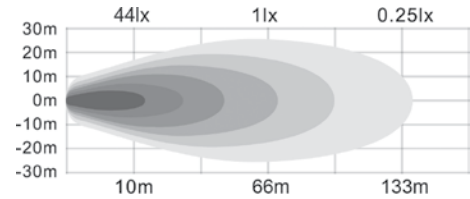
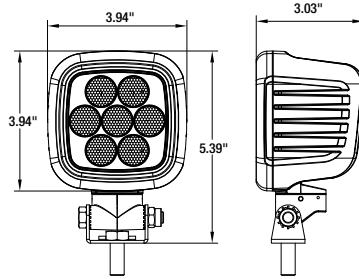

Part No.	Size	LED's	Amps	Lumens	Color	Base / Mount	Lead Length	Connection	Wt. (lbs.)	Cat.
NEW 1492223*	3.75"	21	7.75	2105-7017	Clear	10mm stud SST	28"	Deutsch	2.34	562 (N)

*Available June 2019

Ultra Bright Wide Angle 4" LED Spot/Flood Light

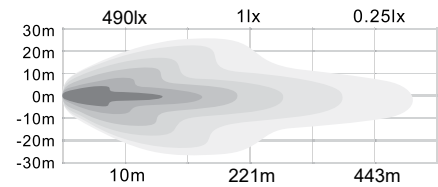
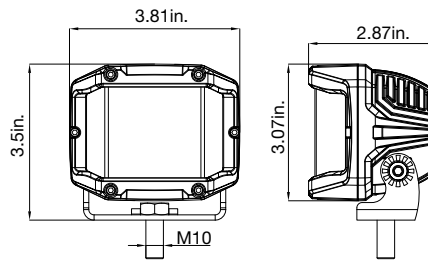

Part No.	Size	LED's	Amps	Lumens	Color	Base / Mount	Lead Length	Connection	Wt. (lbs.)	Cat.
NEW 1492197	3.8"	10	2.18	3,540	Clear	SST	18"	Blunt Cut	1.73	562 (N)

Ultra Bright 4.5" LED Flood Light

• Features TCS (temperature control system), automatically adjusts light for maximum power depending on temperature

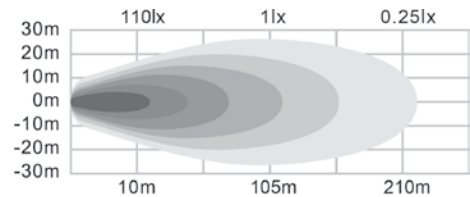
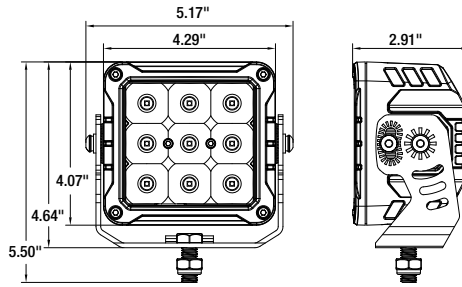

Part No.	Size	LED's	Amps	Lumens	Color	Base / Mount	Lead Length	Connection	Wt. (lbs.)	Cat.
NEW 1492225*	4.375"	36	10	2943-9831	Clear	10mm stud SST	28"	Deutsch	2.9	562 (N)

*Available June 2019

Ultra Bright 4.5" LED Flood Light

• Features TCS (temperature control system), automatically adjusts light for maximum power depending on temperature

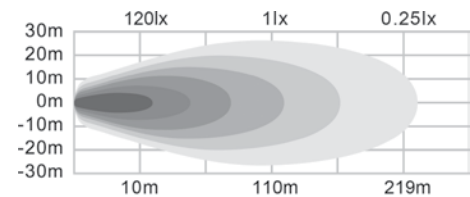
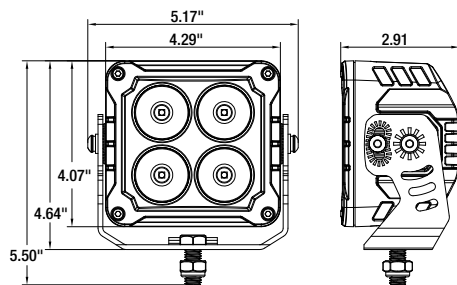

Part No.	Size	LED's	Amps	Lumens	Color	Base / Mount	Lead Length	Connection	Wt. (lbs.)	Cat.
NEW 1492224*	4.375"	16	6.92	1938-6459	Clear	10mm stud SST	28"	Deutsch	3.0	562 (N)

*Available June 2019

Ultra Bright 4.5" LED Flood Light

5-YEAR
W
12-24
VOLTS
IP
67

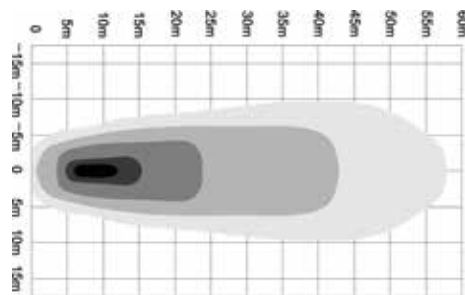
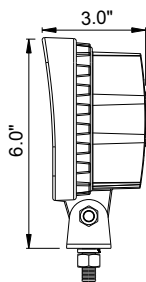
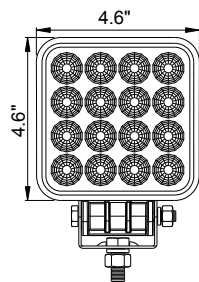

Part No.	Size	LED's	Amps	Lumens	Color	Base / Mount	Lead Length	Connection	Wt. (lbs.)	Cat.
1492128	4.6"	16	2.08	4320	Clear	SST	18"	Blunt Cut	1.66	562 (N)

Ultra Bright 5" LED Flood Light

• Features TCS (temperature control system), automatically adjusts light for maximum power depending on temperature

5-YEAR
W
12-24
VOLTS
IP
67

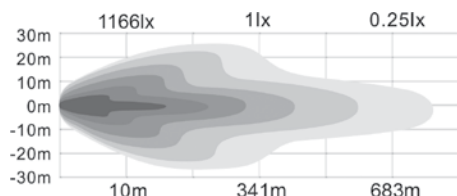
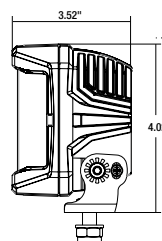
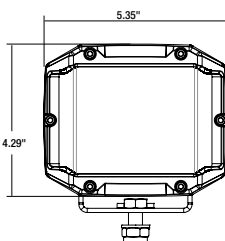

Part No.	Size	LED's	Amps	Lumens	Color	Base / Mount	Lead Length	Connection	Wt. (lbs.)	Cat.
1492222*	5"	17	4.17	3600-4500	Clear	10mm stud SST	28"	Blunt Cut	3.24	562 (N)

*Available June 2019

Ultra Bright 5" LED Flood Light

• Features TCS (temperature control system), automatically adjusts light for maximum power depending on temperature

5-YEAR
W
12-24
VOLTS
IP
67

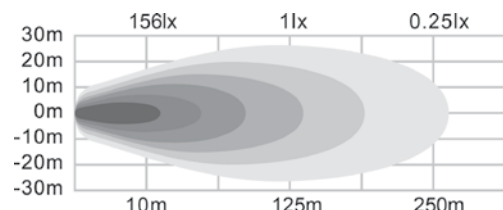
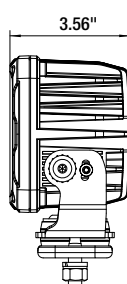
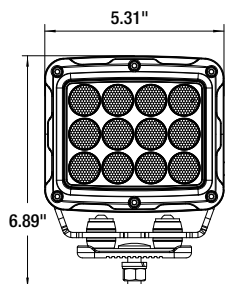

Part No.	Size	LED's	Amps	Lumens	Color	Base / Mount	Lead Length	Connection	Wt. (lbs.)	Cat.
1492226*	5.375"	36	12.42	3600-12000	Clear	10mm stud SST	28"	Deutsch	4.6	562 (N)

*Available June 2019

Ultra Bright 6" LED Flood Light

• Features TCS (temperature control system), automatically adjusts light for maximum power depending on temperature

5-YEAR
W
12-24
VOLTS
IP
67

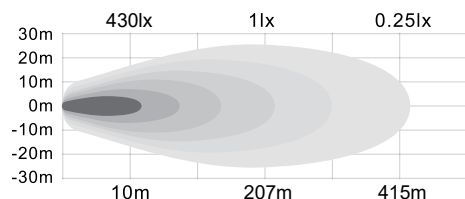
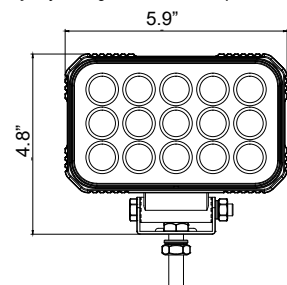

Part No.	Size	LED's	Amps	Lumens	Color	Base / Mount	Lead Length	Connection	Wt. (lbs.)	Cat.
1492196	4.8" x 5.9"	15	6.8	9000	Clear	10mm stud SST	18"	Blunt Cut	1.6	562 (N)

Square Lens

Ultra Bright 6" LED Flood Light

5-YEAR
W
12-24
VOLTS
IP 67

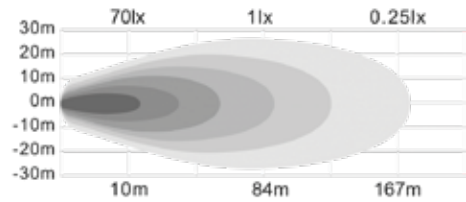
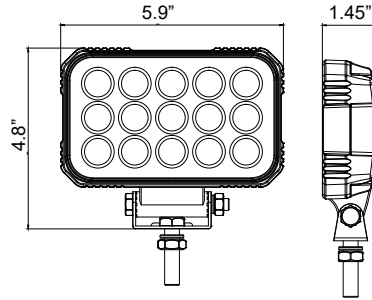

Part No.	Size	LED's	Amps	Lumens	Color	Base / Mount	Lead Length	Connection	Wt. (lbs.)	Cat.
1492190	4.8" x 5.9"	15	1.96	4050	Clear	10mm stud SST	18"	Blunt Cut	1.6	562 (N)

Ultra Bright 6" LED Spot Light

5-YEAR
W
12-24
VOLTS
IP 67

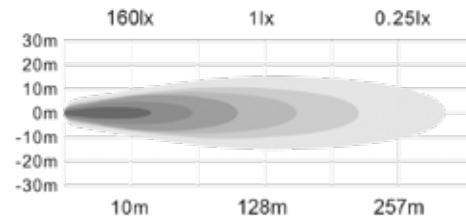
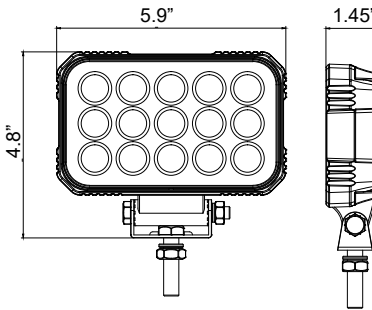

Part No.	Size	LED's	Amps	Lumens	Color	Base / Mount	Lead Length	Connection	Wt. (lbs.)	Cat.
1492290	4.8" x 5.9"	15	1.96	4050	Clear	10mm stud SST	18"	Blunt Cut	1.6	562 (N)

Ultra Bright 6.5" LED Flood Light

5-YEAR
W
12-24
VOLTS
IP 68

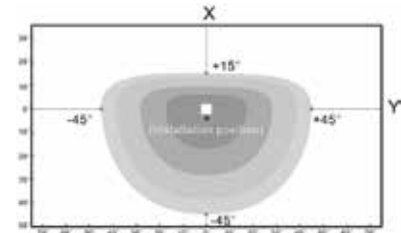
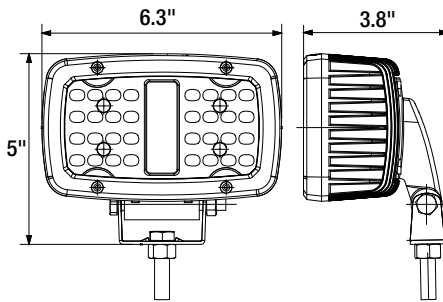

Part No.	Size	LED's	Amps	Lumens	Color	Base / Mount	Lead Length	Connection	Wt. (lbs.)	Cat.
1492194	6.3"	36	4.9	7920	Clear	10mm stud SST	11"	Blunt Cut	1.88	562 (N)

Ultra Bright 8" LED Flood Light

5-YEAR
W
12-24
VOLTS
IP 67

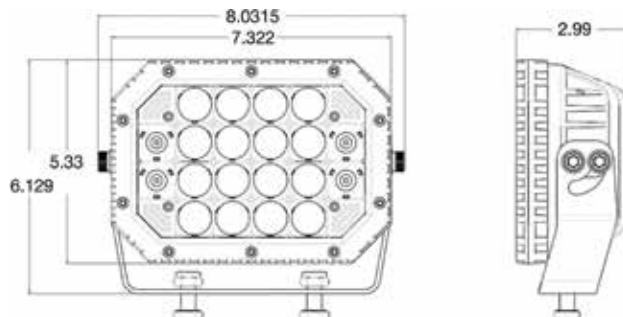

Part No.	Size	LED's	Amps	Lumens	Color	Base / Mount	Lead Length	Connection	Wt. (lbs.)	Cat.
1492195*	8"	20	5.7	9100	Clear	SST Bracket	20"	Blunt Cut	4.0	562 (N)

*Available June 2019

2.5" LED Flood Light

5-YEAR
W
12-24
VOLTS
IP
67

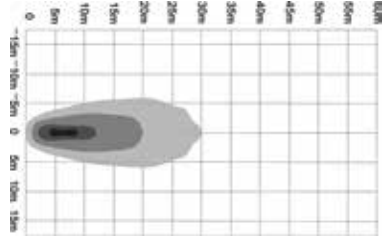
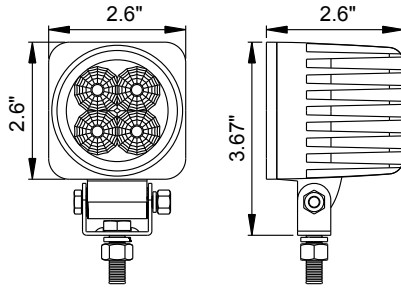

Part No.	Size	LED's	Amps	Lumens	Color	Base / Mount	Lead Length	Connection	Wt. (lbs.)	Cat.
1492129	2.6"	4	1.0	780	Clear	SST	36"	Blunt Cut	1.0	562 (N)

3" LED Flood Light

5-YEAR
W
12-24
VOLTS
IP
67

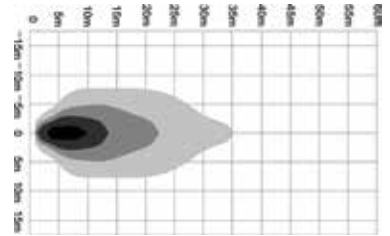
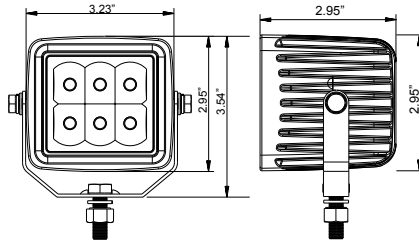

Part No.	Size	LED's	Amps	Lumens	Color	Base / Mount	Lead Length	Connection	Wt. (lbs.)	Cat.
1492137	3.23"	6	1.5	1620	Clear	SST	18"	Blunt Cut	1.5	562 (N)

3" LED Spot Light

5-YEAR
W
12-24
VOLTS
IP
67

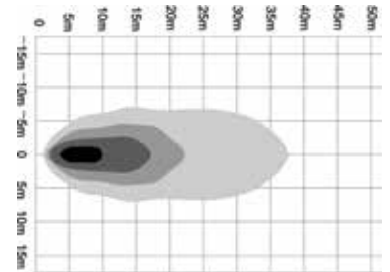
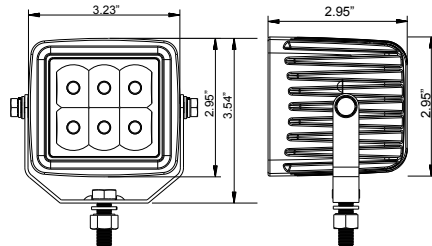

Part No.	Size	LED's	Amps	Lumens	Color	Base / Mount	Lead Length	Connection	Wt. (lbs.)	Cat.
1492237	3.23"	6	1.5	1380	Clear	SST	36"	Blunt Cut	1.5	562 (N)

4" LED Spot Light

5-YEAR
W
12-24
VOLTS
IP
67

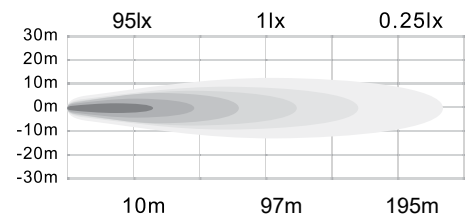
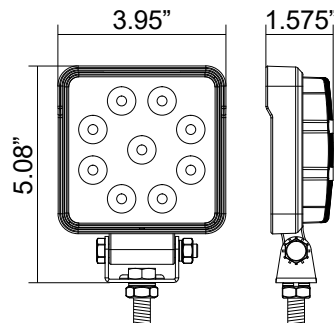

Part No.	Size	LED's	Amps	Lumens	Color	Base / Mount	Lead Length	Connection	Wt. (lbs.)	Cat.
1492134	3.95"	9	1.25	2430	Clear	SST	18"	Blunt Cut	1.12	562 (N)

Square Lens

4" LED Flood Light

5-YEAR
W
12-24
VOLTS
IP
67

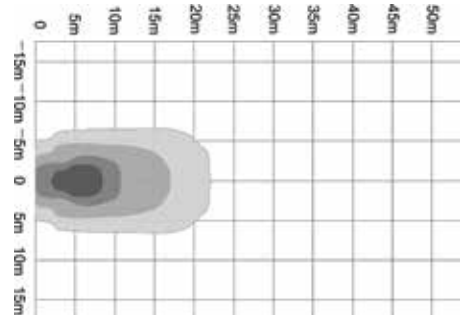
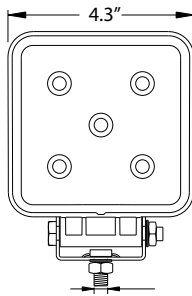

Part No.	Size	LED's	Amps	Lumens	Color	Base / Mount	Lead Length	Connection	Wt. (lbs.)	Cat.
1492117	4.3"	5	1.2	1050	Clear	SST	36"	Blunt Cut	1.20	562 (N)

4" LED Flood Light

5-YEAR
W
12-24
VOLTS
IP
67

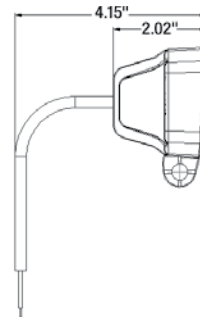
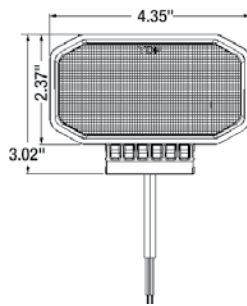

Part No.	Size	LED's	Amps	Lumens	Color	Base / Mount	Lead Length	Connection	Wt. (lbs.)	Cat.
1492220*	4.35"	10	1	1800	Clear	10mm stud SST	14"	Blunt Cut	0.90	562 (N)

*Available June 2019

5" LED Flood Light

5-YEAR
W
12-24
VOLTS
IP
67

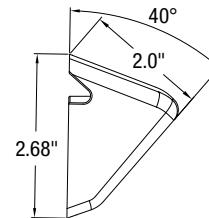
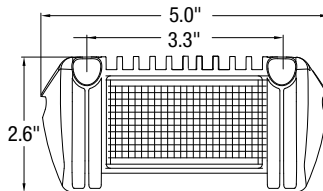

Part No.	Size	LED's	Amps	Lumens	Color	Base / Mount	Lead Length	Connection	Wt. (lbs.)	Cat.
1492199*	5"	9	0.75	725	Clear	Black Aluminum	15"	Blunt Cut	0.79	562 (N)

*Available June 2019

5" LED Switch and Handle Flood Light

5-YEAR
W
12-24
VOLTS
IP
67

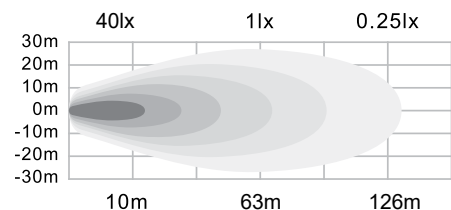
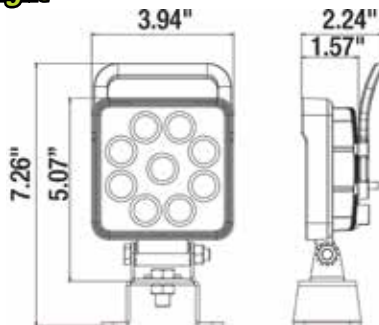

Part No.	Size	LED's	Amps	Lumens	Color	Base / Mount	Lead Length	Connection	Wt. (lbs.)	Cat.
1492193	5.3"	9	2.25	1710	Clear	SST	36"	Blunt Cut	1.76	562 (N)

5" LED Flood Light

5-YEAR W
12-24 VOLTS
IP 67

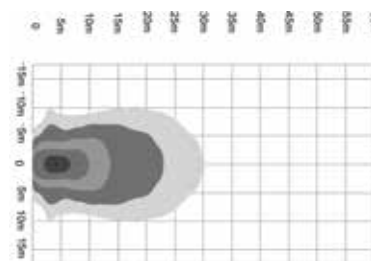
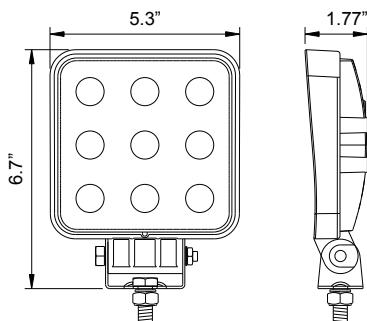

Part No.	Size	LED's	Amps	Lumens	Color	Base / Mount	Lead Length	Connection	Wt. (lbs.)	Cat.
1492119	5.3"	9	2.25	1500	Clear	8mm stud SST	36"	Blunt Cut	1.76	562 (N)

5.5" LED Flood Light

5-YEAR W
12-24 VOLTS
IP 67

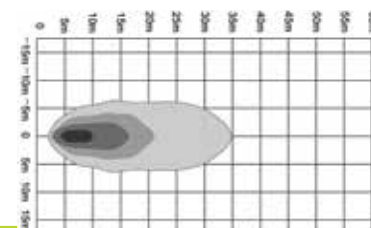
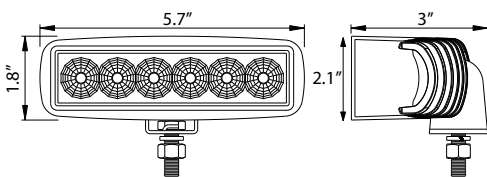

Part No.	Size	LED's	Amps	Lumens	Color	Base / Mount	Lead Length	Connection	Wt. (lbs.)	Cat.
1492135	5.7"	6	1.5	1620	Clear	SST	18"	Blunt Cut	1.6	562 (N)

6" LED Flood Light

5-YEAR W
12-24 VOLTS
IP 67

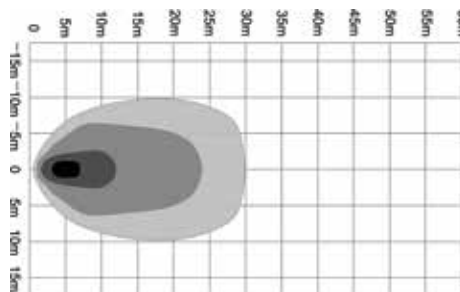
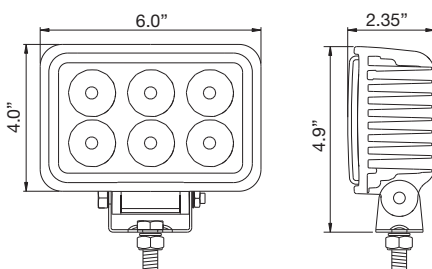

Part No.	Size	LED's	Amps	Lumens	Color	Base / Mount	Lead Length	Connection	Wt. (lbs.)	Cat.
1492118	4" x 6"	6	1.5	1350	Clear	10mm stud SST	36"	Blunt Cut	1.75	562 (N)

Work Light with Built-In Backup Camera



- Produces 1100 lumens of light
- Durable camera features a 976 (H) x 592 (V) pixel resolution
- Night vision capabilities and a wide 140° viewing angle to help capture everything going on even in low visibility situations

Part No.	Description	Cat.
NEW 8883111	Square Work Lamp Camera	888 (N)

Stainless Steel Mounts

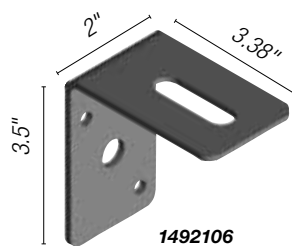

1492106

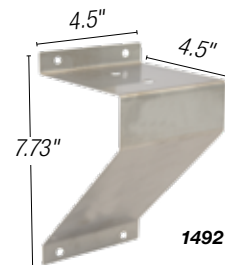

1492107

Part No.	Description	Wt. (lbs.)	Cat.
1492106	Stainless Steel Bracket	0.47	562 (N)
1492107	Stainless Steel Bracket	0.90	562 (N)

Specialty Mount Lights

4" LED Fog Light

5-YEAR
W
12-24
VOLTS
IP
67

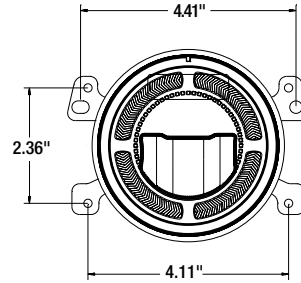
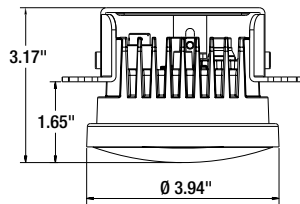

Part No.	Size	LED's	Amps	Lumens	Color	Base / Mount	Lead Length	Connection	Wt. (lbs.)	Cat.
1492221	4"	1	0.71	483	Clear	SST	18"	Blunt Cut	1.47	562 (N)

Recessed 3" LED Flood Light

• Recessed Mount

5-YEAR
W
12-24
VOLTS
IP
67

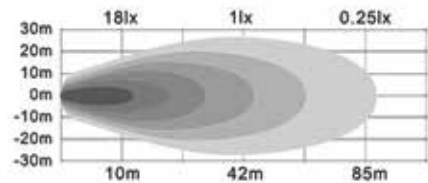
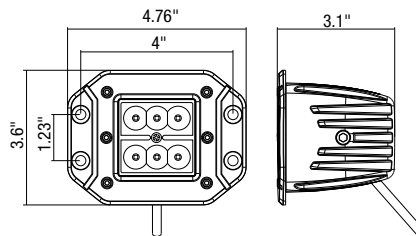

Part No.	Size	LED's	Amps	Lumens	Color	Base / Mount	Lead Length	Connection	Wt. (lbs.)	Cat.
1492138	2.875"	6	1.38	1620	Clear	12 mm stud	18"	Blunt Cut	1.37	562 (N)

Angle Mounted 3" LED Flood Light

• Mounting options included: flat, tubular and angle

5-YEAR
W
12-24
VOLTS
IP
67

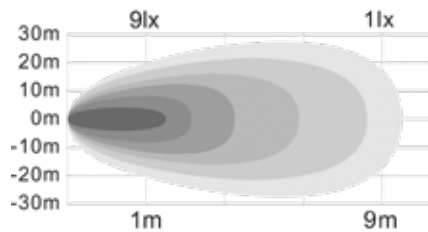
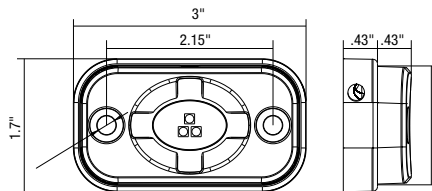

Part No.	Size	LED's	Amps	Lumens	Color	Housing	Lead Length	Connection	Wt. (lbs.)	Cat.
1492139	3" x 1-1/2"	3	0.34	1260	Clear	Black Aluminum	18"	Blunt Cut	0.32	562 (N)

Recessed 6.5" LED Flood Light

• Includes 30° rubber offset mount

5-YEAR
W
12-24
VOLTS
IP
67



Side view of Rubber Mount

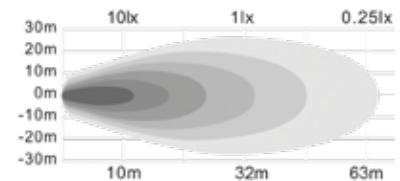
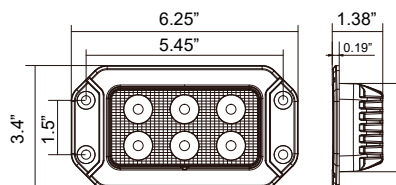

Part No.	Size	LED's	Amps	Lumens	Color	Base / Mount	Lead Length	Connection	Wt. (lbs.)	Cat.
1492191	6.25"L x 1.37"W x 3.42"T	6	0.75	1140	Clear	Recessed, Diecast	18"	Blunt Cut	1.2	562 (N)

Straight Single Row LED Combination *Spot/Flood Light Bar*

- Adjustable width mounts



20.5"

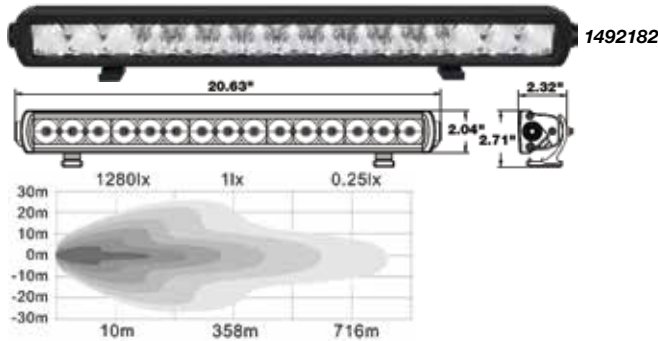

32"

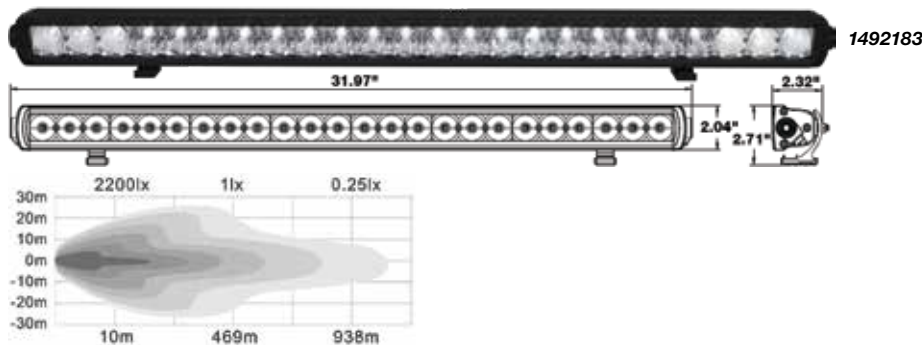

39.5"

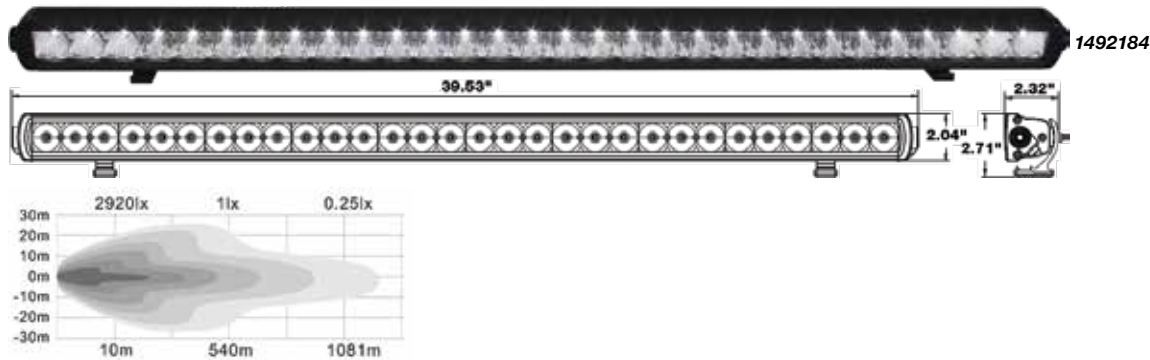

51"

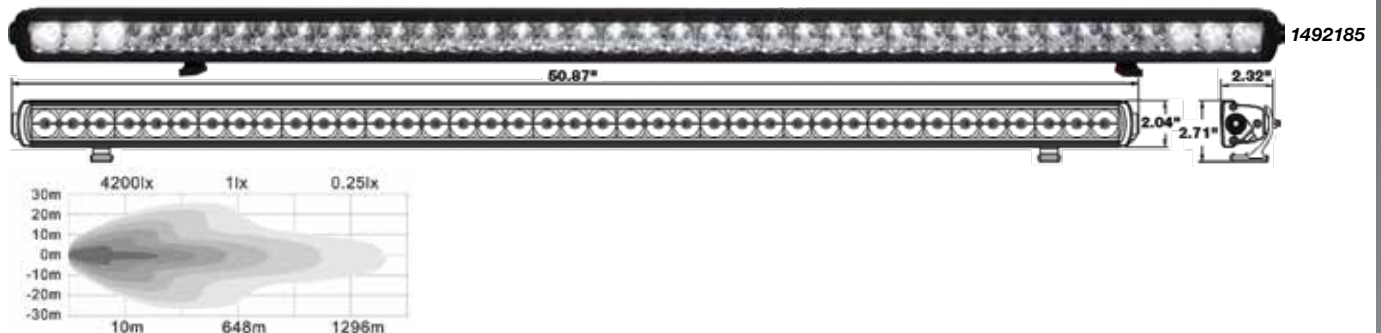





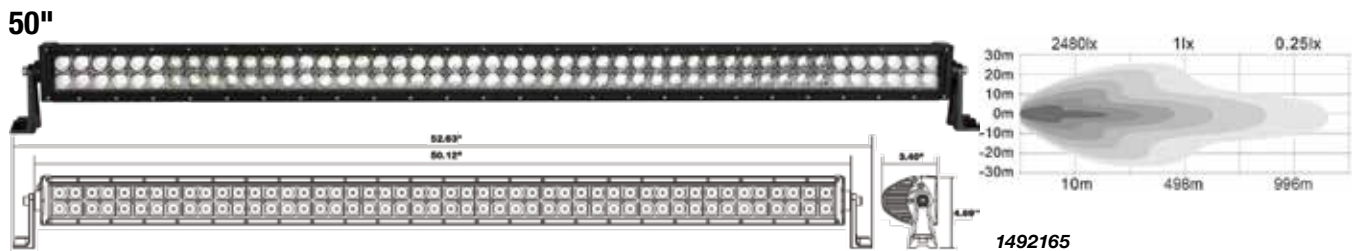
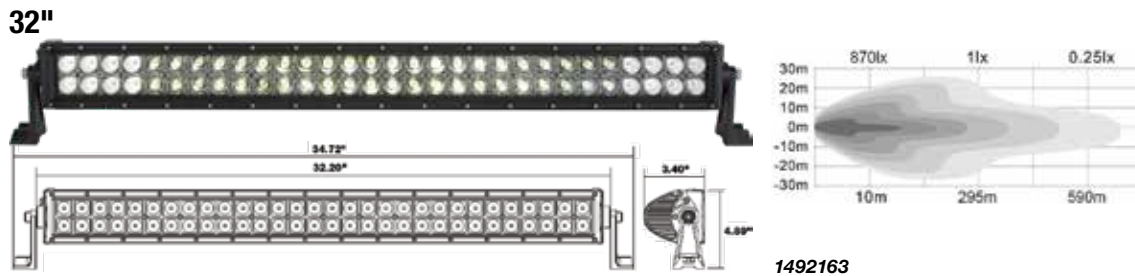
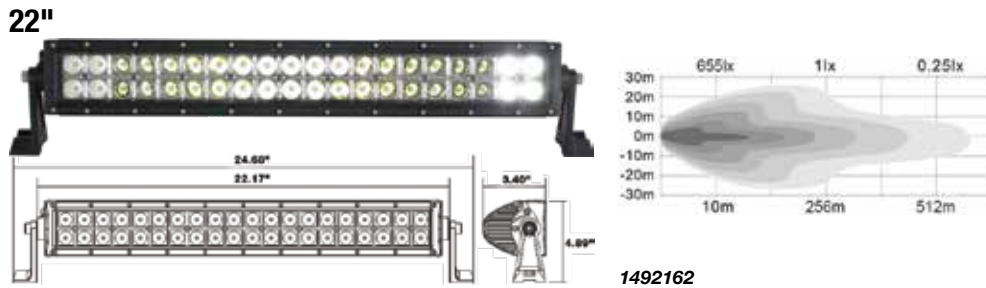
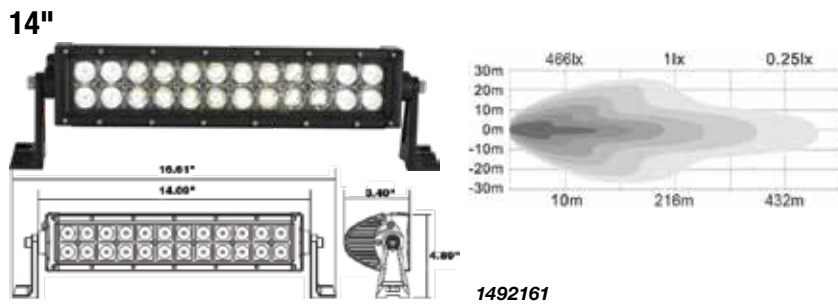
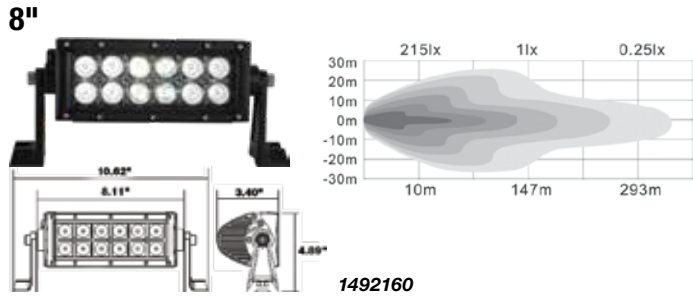

Part No.	Size	LED's	Amps	Lumens	Color	Base / Mount	Lead Length	Connection	Wt. (lbs.)	Cat.
1492182	20.63"	15	2.80	4050	Clear	Aluminum	30.5"	Blunt Cut	3.7	562 (N)
1492183	31.97"	24	4.55	6480	Clear	Aluminum	30.5"	Blunt Cut	5.45	562 (N)
1492184	39.53"	30	5.78	8100	Clear	Aluminum	30.5"	Blunt Cut	6.62	562 (N)
1492185	50.87"	39	7.60	10530	Clear	Aluminum	30.5"	Blunt Cut	8.8	562 (N)

LED Spot-Flood Light Bars

Ultra Bright LED Combination *Spot/Flood Light Bar*

5-YEAR
W **12-24**
VOLTS **IP**
67



Part No.	Size	LED's	Amps	Lumens	Color	Base / Mount	Lead Length	Connection	Wt. (lbs.)	Cat.
 1492160	8.11"	12	2	3240	Clear	Aluminum	33.5"	Blunt Cut	3.34	562 (N)
 1492161	14.09"	24	4.20	6480	Clear	Aluminum	33.5"	Blunt Cut	4.98	562 (N)
 1492162	22.17"	40	8.20	10800	Clear	Aluminum	52.5"	Blunt Cut	7.34	562 (N)
 1492163	32.20"	60	12.00	16200	Clear	Aluminum	52.5"	Blunt Cut	10.15	562 (N)
 1492165	50.12"	96	16.60	25920	Clear	Aluminum	52.5"	Blunt Cut	15.42	562 (N)

Ultra Bright LED Curved Combination *Spot/Flood Light Bar*

5-YEAR
W 12-24
VOLTS **IP**
67

14"

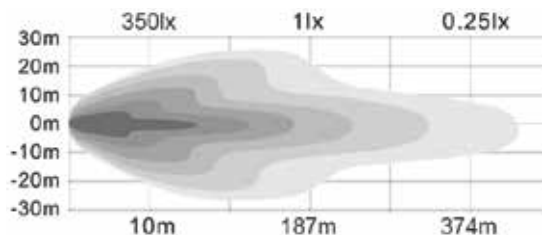
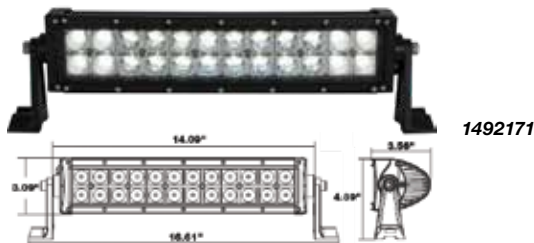

22"

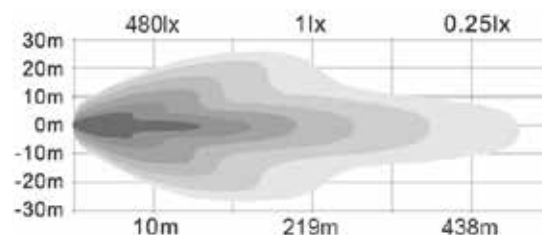
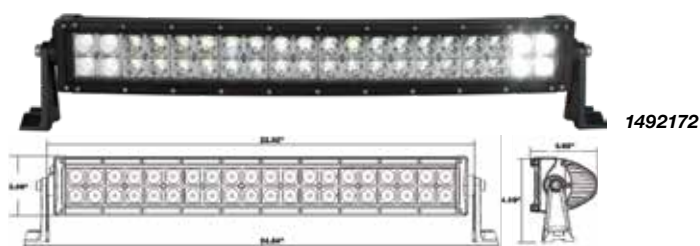

Part No.	Size	LED's	Amps	Lumens	Color	Base / Mount	Lead Length	Connection	Wt. (lbs.)	Cat.
1492171	14.09"	24	4.20	6480	Clear	Aluminum	33.5"	Blunt Cut	4.93	562 (N)
1492172	22.32"	40	8.20	10800	Clear	Aluminum	52.5"	Blunt Cut	7.29	562 (N)

Rear Mount Mounting Legs, Pair

- For 1492160 & 1492170 series



Part No.	Description	Wt. (lbs.)	Cat.
3034110	Rear Mount Mounting Legs, Pair	0.66	562 (N)

Tube Mount, Pair



Part No.	Description	Wt. (lbs.)	Cat.
3035781	Tube Mount, Pair	1.44	562 (N)

Tube X Mount, Pair



Part No.	Description	Wt. (lbs.)	Cat.
3035783	Tube X Mount, Pair	1.76	562 (N)

Harness with Single Switch

- For 1492160, 1492170, 1492180 series work lights



Part No.	Description	Wt. (lbs.)	Cat.
3035768	Harness with Single Switch, DT Connection	0.93	562 (N)
3035770	Harness with Single Switch, ATP Connection	1.04	562 (N)

LED Strip and Tube Lights

LED Strip Lights With 3M™ Adhesive Back

- Commercial grade housing
- Wired at both ends
- End caps and mounting clips included
- Can be cut every 3 LEDs
- Custom lengths and connectors available upon request

5-YEAR
W
12
VOLTS
IP
67

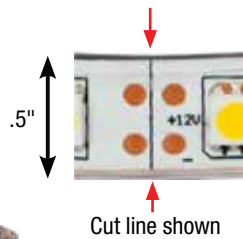

Part No.	Size	LED's	Amps	Lumens	Color	Connection	Std. Qty.	Wt. (lbs.)	Cat.
5621827	18"	27	0.41	360	Clear, Warm	Blunt Cut, Both Ends	1	0.31	562 (N)
5621928	18"	27	0.41	360	Clear, Cool	Blunt Cut, Both Ends	1	0.31	562 (N)
5622436	24"	36	0.54	470	Clear, Warm	Blunt Cut, Both Ends	1	0.35	562 (N)
5622537	24"	36	0.54	470	Clear, Cool	Blunt Cut, Both Ends	1	0.35	562 (N)
5622638	24"	36	0.54	470	Red	Blunt Cut, Both Ends	1	0.35	562 (N)
5622739	24"	36	0.54	470	Blue	Blunt Cut, Both Ends	1	0.35	562 (N)
5623654	36"	54	0.81	710	Clear, Warm	Blunt Cut, Both Ends	1	0.40	562 (N)
5623755	36"	54	0.81	710	Clear, Cool	Blunt Cut, Both Ends	1	0.40	562 (N)
5624872	48"	72	1.12	940	Clear, Warm	Blunt Cut, Both Ends	1	0.44	562 (N)
5624973	48"	72	1.12	940	Clear, Cool	Blunt Cut, Both Ends	1	0.44	562 (N)
5625074	48"	72	1.12	940	Red	Blunt Cut, Both Ends	1	0.44	562 (N)
5625175	48"	72	1.12	940	Blue	Blunt Cut, Both Ends	1	0.44	562 (N)
5626090	60"	90	1.30	1180	Clear, Warm	Blunt Cut, Both Ends	1	0.55	562 (N)
5626191	60"	90	1.30	1175	Clear, Cool	Blunt Cut, Both Ends	1	0.55	562 (N)
5626292	60"	90	1.30	1175	Amber	Blunt Cut, Both Ends	1	0.55	562 (N)
56296144	96"	144	2.00	2160	Clear, Warm	Blunt Cut, Both Ends	1	0.88	562 (N)
56297145	96"	144	2.00	2160	Clear, Cool	Blunt Cut, Both Ends	1	0.88	562 (N)
56298146	96"	144	2.00	1880	Amber	Blunt Cut, Both Ends	1	0.88	562 (N)
562109166	108"	165	3.00	2400	Clear, Cool	Blunt Cut, Both Ends	1	1.12	562 (N)
562133202	132"	201	4.00	3000	Clear, Cool	Blunt Cut, Both Ends	1	1.37	562 (N)
3035896	LED Strip Light Mounting Channel, 17-1/2" Long, Black, Mounting 3M® Tape								562 (N)

LED Tubes Light

5-YEAR
W
12-24
VOLTS

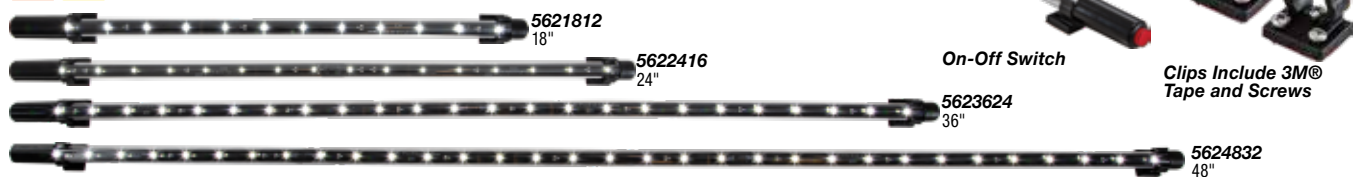

Part No.	Size	LED's	Amps	Lens Color	Connection	Lumens	Mounting	Std. Qty.	Wt. (lbs.)	Cat.
5621812	18"	12	.21	Clear	8" Blunt Cut	144	Surface	1	.23	562 (N)
5622416	24"	16	.29	Clear	8" Blunt Cut	192	Surface	1	.28	562 (N)
5623624	36"	24	.34	Clear	8" Blunt Cut	288	Surface	1	.38	562 (N)
5624832	48"	32	.45	Clear	8" Blunt Cut	384	Surface	1	.48	562 (N)

Strobe Controller

5-YEAR
W



- 15 Watts MAX (6A@12V)
- Will not work with lengths exceeding 48"
- Mounts with included 3M adhesive foam tape
- Make connections quick with included quick splice connectors
- Works with steady burning 12VDC light(s) up to 6A

Part No.	Size	Amps	Operating Temp	Connection	Std. Qty.	Wt. (lbs.)	Cat.
5621002	1" x 1-1/2"	6.0	-22 to 176	6" Lead	1	0.07	562 (N)

5" Round Incandescent Interior Dome Light

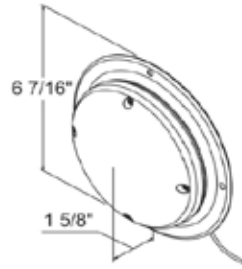

Part No.	Size	Amps	Color	Bulb	On-Off Switch	Std. Qty.	Wt. (lbs.)	Cat.
 5625030	4.6"	2.2	Clear	1156	Yes	1	0.5	562 (N)

5" Round LED Interior Dome Lights

- 12-24 VDC
- 1.5A



5625336

- for remote switch



5625337

- with built-in switch



5625338

- with motion sensor

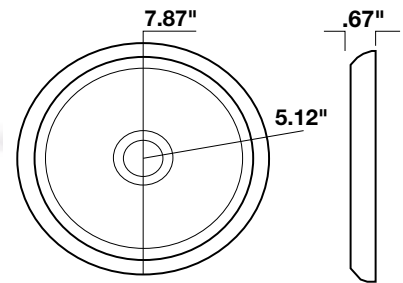

Part No.	Size	LED's	Lens Color	Connection	Lumens	Mounting	Std. Qty.	Wt. (lbs.)	Cat.
5625336	5.1"	36	Clear	8" Blunt Cut	2200	Surface	1	0.39	562 (N)
5625337	5.1"	36	Clear	8" Blunt Cut	2200	Surface	1	0.39	562 (N)
5625338	5.1"	36	Clear	8" Blunt Cut	2200	Surface	1	0.39	562 (N)

Oval LED Interior Dome Lights

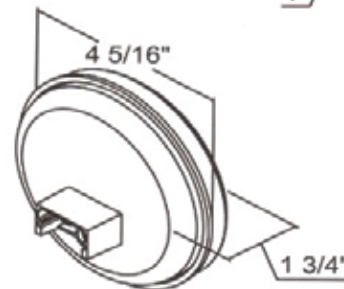
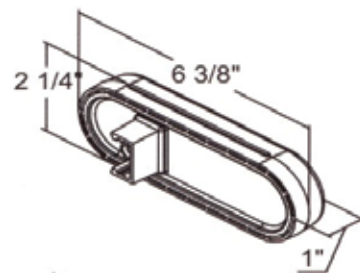

Part No.	Size	LED's	Lens Color	Connection	Lumens	Mounting	Amp	Std. Qty.	Wt. (lbs.)	Cat.
5626352	6"	10	Clear	PL-3 Connection	80	Grommet	.221	10	0.37	562 (N)
5624352	4"	10	Clear	PL-3 Connection	80	Grommet	.221	10	0.34	562 (N)

See mounting grommets on page C11



LED Strip, Projector and Rope Lights

4.4" LED Projector Light



- Ideal for cab steps and perimeter ground lighting

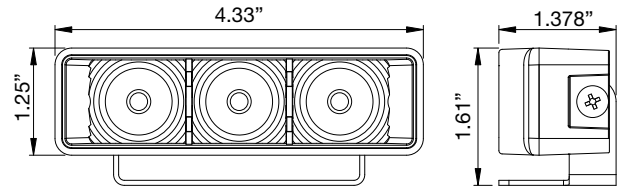

Part No.	Size	LED's	Amps	Lumens	Color	Base / Mount	Lead Length	Connection	Std. Qty.	Wt. (lbs.)	Cat.
5624433	4.4"	3	.30	120	Clear	Aluminum/SS Bracket	36"	Blunt Cut	1	0.37	562 (N)

LED Rope Light with Connections and Mounts



- Mounting hardware and connections included
- Can be cut every 3 LEDs

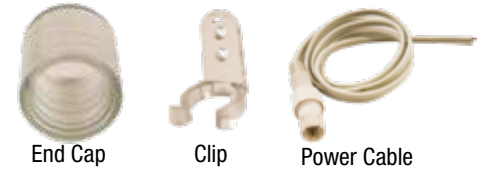

Part No.	Size	LED's	Amps	Lumens	Color	Base / Mount	Connection	Std. Qty.	Wt. (lbs.)	Cat.
5625576	52.5'	576	3.8	48-60/ft.	Clear	Clips	Plug	1	6	562 (N)

Universal Snowplow Light Kit



- Dual beam halogen headlamps with turn signal/parking light
- High-impact polycarbonate case
- Double-post mounts
- Includes universal wiring harness

Part No.	Description	Cat.
1311100	Universal Light Kit	889 (N)
1311110	Headlight Adapter for International® Trucks	889 (N)
3014194	Low Beam Replacement Bulb	889 (N)
3014193	Hi Beam Replacement Bulb	889 (N)
1311103	Park/Turn, Amber, Replacement Bulb	889 (N)

Stainless Steel Truck Hood Light Brackets



PLB12SS for use with 1311100 dual stud plow lights



PLB11SS for use with single stud plow lights

- Kit Includes driver & passenger side bracket, gaskets & fasteners
- Stainless steel
- Universal fit for med./hvy. class truck hoods:
Ford, Freightliner, GMC, International, Mack, Peterbilt, Sterling, Volvo

Part No.	Description	Cat.
PLB11SS	Unwelded Bracket, Stainless Steel with Hardware	889 (N)
PLB12SS	Unwelded Bracket, Extended, Stainless Steel with Hardware	889 (N)

LED Modular Light Bar Series



- Standard with amber strobes
- Customize by adding amber, blue, green, clear and/or red strobes
- Middle strobes have 3-LED reflector heads
- Corner strobes have 6-LED D-fuser heads
- Dimming mode
- Extruded aluminum frame
- 13" wide x 2" tall
- Optional work lights and take down lights on 49", 54" & 60" models
- Mounting feet and controller sold separately (see pg C18)
- Available in 24", 49", and 60" sizes
 - 54" models available - call for quotes

24" LED Modular Light Bar



49" LED Modular Light Bar



60" LED Modular Light Bar



Part No.	Size	LEDs	Amp	Modules Description	Chassis Diagram	Wt. (lbs.)	Cat.
8893024	24"	36	3-6	8 Amber		15.4	889 (N)
88930243	24"	36	3-6	4 Amber, 4 Clear		15.4	889 (N)
8893049	49"	54	7-14	14 Amber Built-in Traffic Advisor		33.0	889 (N)
88930492	49"	36	7-14	8 Amber		31.8	889 (N)
88930493	49"	36	7-14	4 Amber, 4 Clear		31.8	889 (N)
8893060	60"	60	8-16	14 Amber, 2 Red LED Stop-Turn-Tail Lights Built-in Traffic Advisor		36.1	889 (N)
88930603	60"	42	8-16	8 Amber, 2 Red LED Stop-Turn-Tail Lights 2 LED Take Down Lights		34.7	889 (N)
88930604	60"	48	8-16	12 Amber		34.9	889 (N)
88930605	60"	60	8-16	16 Amber Built-in Traffic Advisor		36.1	889 (N)

Amber Strobe
 Clear Strobe
 Red Strobe
 Stop-Turn-Tail Lights
 Clear Strobe
 Take Down Lights

Buyers Custom Light Bars

Customizing Stock Light Bars

Modular light bars can be customized by purchasing the accessory light heads listed below. This allows light heads to be added or colors to be changed, without having to buy a new light bar. Takedown and alley lights can also be added to 49", 54" and 60" models (not 24").

Custom Light Bar Program

Factory built custom modular light bars are also available in 24", 49", 54" and 60" lengths. Customers choose their light head configuration and colors. Buyers Products will then quote, build, test, and ship the custom light bar. Call or email customer service at (440) 974-8888, customercare@buyersproducts.com or visit buyersproducts.com for more information.

LED Middle Strobe



Part No.	LEDs	Color	Wt. (lbs.)	Cat.
3024631	3	Amber	0.28	889 (N)
3024632	3	Clear	0.27	889 (N)
3024633	3	Red	0.28	889 (N)
3024634	3	Blue	0.27	889 (N)
3032932*	3	Green	0.28	889 (N)

* 3032932 is not CA13 or SAE J595 Class 1

LED Corner Strobe



Part No.	LEDs	Color	Wt. (lbs.)	Cat.
3024635	6	Amber	0.21	889 (N)
3024636	6	Clear	0.20	889 (N)
3024637	6	Red	0.21	889 (N)
3024638	6	Blue	0.21	889 (N)
3032933	6	Green	0.21	889 (N)

LED Middle Take Down Light Head



Part No.	LEDs	Color	Wt. (lbs.)	Cat.
3024639	6	Clear	0.23	889 (N)
3024640	9	Clear	0.23	889 (N)

LED Alley Lights



Part No.	LEDs	Color	Wt. (lbs.)	Cat.
3024642	3	Clear	0.14	889 (N)

Steel Mounting Feet for LED Modular Light Bar



- Black powder coated
- Adjustable height

Part No.	Material	Size	Wt. (lbs.)	Cat.
3024646	Plastic	12.625"L x 5.50"W x 2.25"T	2.58	889 (N)
3024647	Steel	10.125"L x 6.5"W x 2-3"T	3.89	889 (N)

* Use with Stainless Steel Strap Kits

Steel Mounting Feet

- Black powder coat



Part No.	Description	Wt. (lbs.)	Cat.
3024648	4.5"L x 6.75"W x 1.75"T	3.16	889 (N)
3024649	Wide Surface 8.75"L x 2.50"W x 2.25"T	2.47	889 (N)

4 Switch Panel, Pre-Wired

- For use with 49", 54" & 60" modular light bars
- 3.75"L x 1.25"W x 1.5"T
- Built-in traffic advisor controls



Part No.	Description	Wt. (lbs.)	Cat.
6391204	4-Switch Panel, Pre-Wired	0.27	639 (N)

Stainless Steel Strap Kits for LED Modular Light Bar



Part No.	Description	Wt. (lbs.)	Cat.
3025442	GM1500/2500/3500/4500/5500, Light Bars: 49", 54" and 60"	1.53	889 (N)
3026114	F-150 (2004-2014), Light Bars: 49", 54" & 60"	1.60	889 (N)
3034400	F-150 (15+) F250/F550 (17+), 49", Light Bars: 54" & 60"	1.60	889 (N)
3026115	F-250/350/450/550 (1999-2016), Light Bars: 49", 54" & 60"	1.60	889 (N)
3026116	RAM 500/2500/3500/4500/5500, (09-18), Light Bars: 49", 54" and 60"	1.60	889 (N)

5 Switch Panel, Pre-Wired

- For use with 24", 49", 54" & 60" modular light bars, plus surface and recessed mounted strobes
- 3.5"L x 1.0"W x 2.5"T



Part No.	Description	Wt. (lbs.)	Cat.
6391205	5-Switch Panel, Pre-Wired	0.35	639 (N)

6, 7 or 8 Switch Panel, Pre-Wired with LED Pattern Display

- For use with 49", 54" and 60" modular light bars
- Programmable
- Built-in traffic advisor controls



Part No.	Description	Wt. (lbs.)	Cat.
6391206	6-Switch Panel, Pre-Wired with LED Pattern Display	0.39	639 (N)
6391208	Switch Panel, 7 Function, Multi-Purpose, Programmable	0.83	639 (N)
6391209	Switch Panel, 8 Function, Multi-Purpose, Programmable, with Relays	0.83	639 (N)

LED Mini Light Bars

49" Fleet Series Light Bar



- Integrated, pre-wired, in-cab controller for ease of use and installation
- In-cab controller boasts 14 flash patterns in addition to directional "traffic arrow" patterns, and steady "on" position
- Light is provided by 22 amber LED strobe heads, each with six 1W LEDs
- Durable extruded aluminum housing with black powder coat finish
- 25' cord and pre-wired controller with 12 functions
- Permanent mount with gutter clamps



Part No.	Size	LEDs	Color	Amp	Mount	House	Flash Patterns	Wt. (lbs.)	Cat.
8892048	47.2"L x 12.2"W x 4.3"H	22	Amber	10	Permanent	Aluminum	14	39.2	889 (N)

11" Rectangular Multi-Mount LED Mini Light Bar



- Includes 15' cord

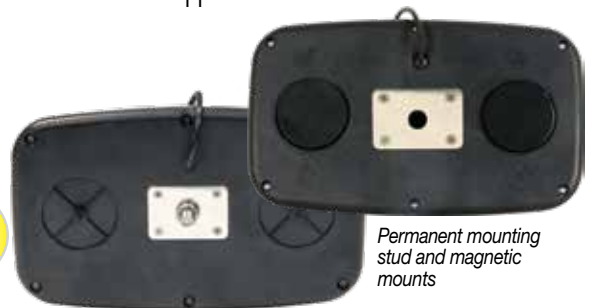
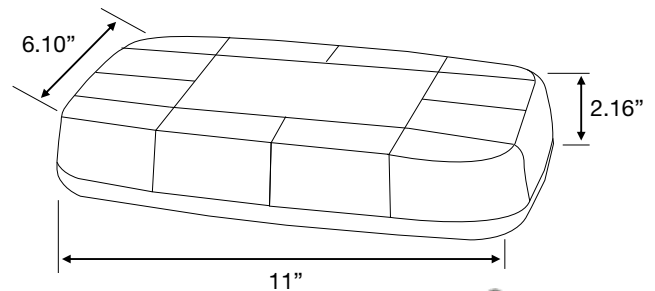

Permanent mounting stud and magnetic mounts

Part No.	Size	LEDs	Color	Amp	Mount	Power	Flash Patterns	Wt. (lbs.)	Cat.
8891040	11"L x 6.5"W x 2.25"H	24	Amber	2	Magnetic or Permanent	DC Adapter	10	3.5	889 (N)
8891042	11"L x 6.5"W x 2.25"H	24	Amber/Clear	2	Magnetic or Permanent	DC Adapter	10	3.5	889 (N)
8891044	11"L x 6.5"W x 2.25"H	24	Blue	2	Magnetic or Permanent	DC Adapter	10	3.5	889 (N)
8891048	11"L x 6.5"W x 2.25"H	24	Green	2	Magnetic or Permanent	DC Adapter	10	3.5	889 (N)
8891049	11"L x 6.5"W x 2.25"H	24	Amber/Green	2	Magnetic or Permanent	DC Adapter	10	3.5	889 (N)

See pg. C26 for Drill-Free Cab Mounts Options

11" Rectangular LED Mini Light Bar



- Includes 15' cord

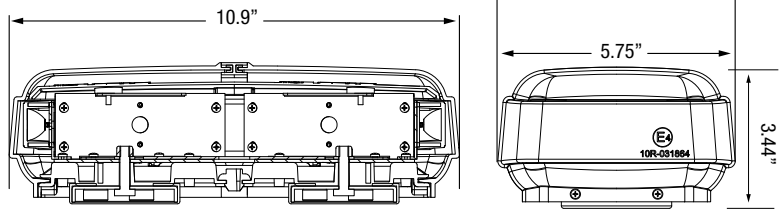
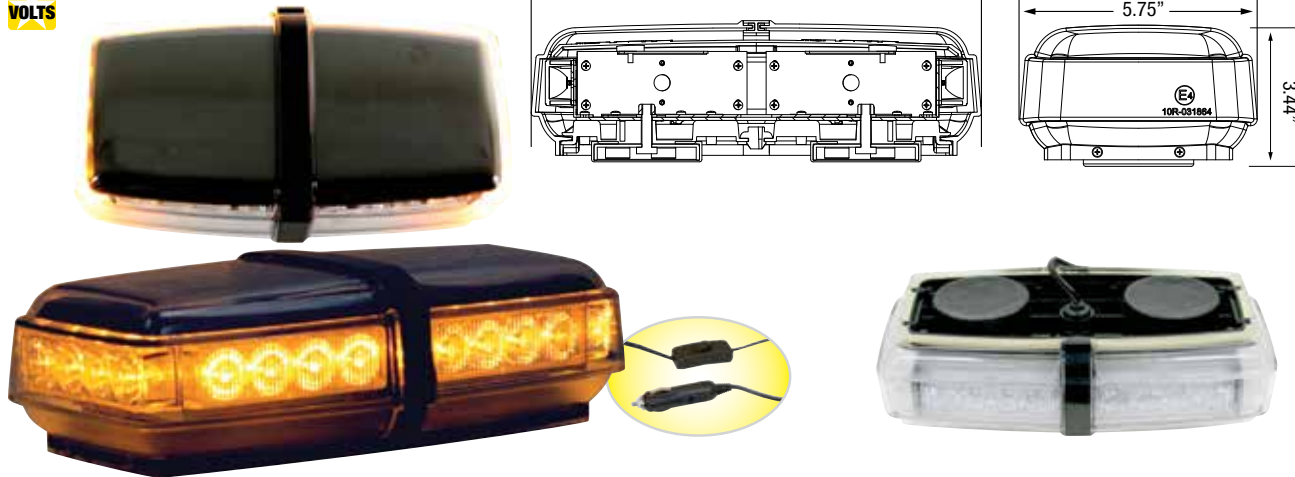

Part No.	Size	LEDs	Color	Amp	Mount	Power	Flash Patterns	Wt. (lbs.)	Cat.
8891050	10.93"L x 5.75"W x 3.44"H	24	Amber	3.5	Magnetic	DC Adapter	Random	4.0	889 (N)
8891052	10.93"L x 5.75"W x 3.44"H	24	Amber/Clear	3.5	Magnetic	DC Adapter	Random	4.0	889 (N)

See pg. C26 for Drill-Free Cab Mounts Options

15" Octagonal LED Mini Light Bar Series



- Includes 15' cord

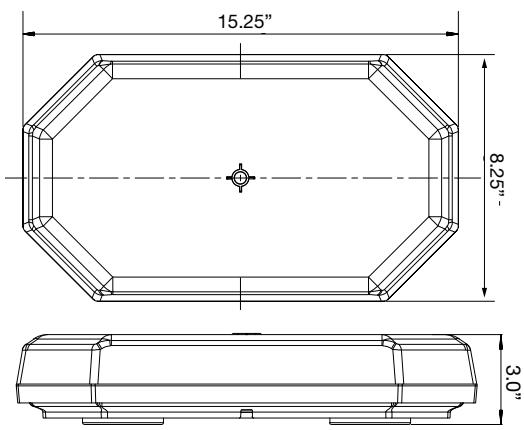

Permanent mounting studs and magnetic mounts

Part No.	Size	LEDs	Color	Amp	Mount	Power	Flash Patterns	Wt. (lbs.)	Cat.
8891060	15"L x 8.25"W x 3"H	56	Amber	3.2	Magnetic or Permanent	DC Adapter	10	5.5	889 (N)
8891062*	15"L x 8.25"W x 3"H	56	Amber/Clear	3.2	Magnetic or Permanent	DC Adapter	10	5.5	889 (N)
8891063*	15"L x 8.25"W x 3"H	56	Red	3.2	Magnetic or Permanent	DC Adapter	10	5.5	889 (N)

*8891062/8891063 are not SAE J595 Class 1
See pg. C26 for Drill-Free Cab Mounts Options

LED Mini Light Bars

15" Oval LED Mini Light Bar

- Includes 15' cord

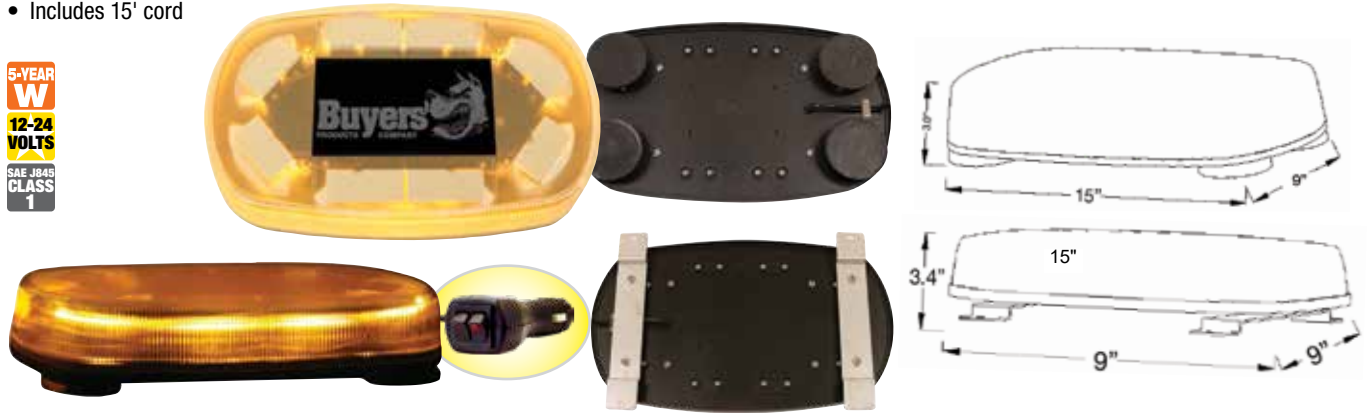

Part No.	Size	LEDs	Color	Amp	Mount	Power	Flash Patterns	Wt. (lbs.)	Cat.
8891070	15"L x 9"W x 3.0"H	32	Amber	3.2	Magnetic	DC Adapter	24	5.0	889 (N)
8891071	15"L x 9"W x 3.4"H	32	Amber	3.2	Permanent	DC Adapter	24	4.7	889 (N)

See pg. C26 for Drill-Free Cab Mounts Options

10" Oval Low Profile LED Mini Light Bar

- Includes 15' cord

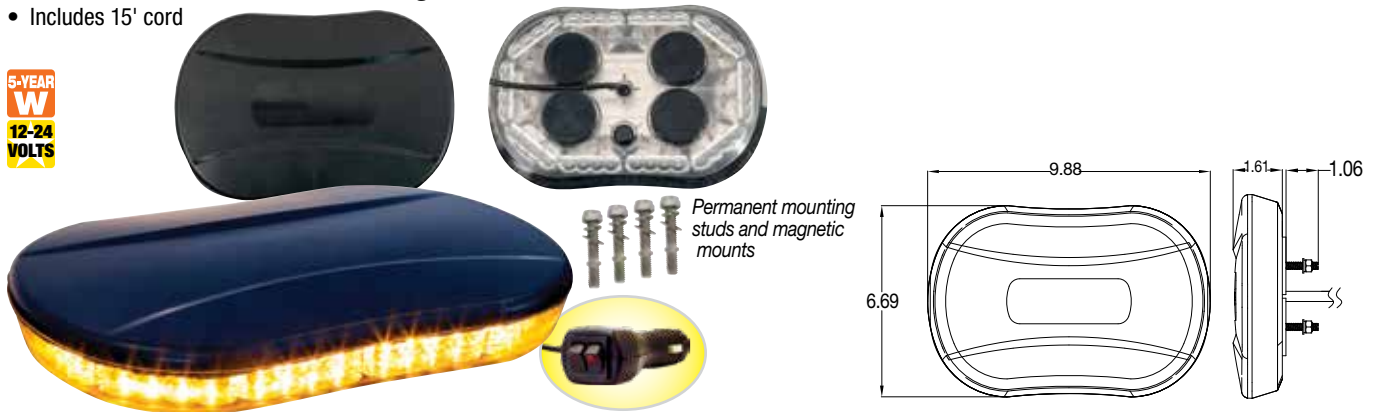

Part No.	Size	LEDs	Color	Amp	Mount	Power	Flash Patterns	Wt. (lbs.)	Cat.
8891080	9.88"L x 6.69"W x 1.61"H	40	Amber	3.34	Magnetic/Permanent	DC Adapter	20	3.10	889 (N)
8891082*	9.88"L x 6.69"W x 1.61"H	40	Amber/Clear	3.34	Magnetic/Permanent	DC Adapter	20	3.10	889 (N)

See pg. C26 for Drill-Free Cab Mounts Options

15" Hexagonal Low Profile Mini Light Bar

- Includes 15' cord

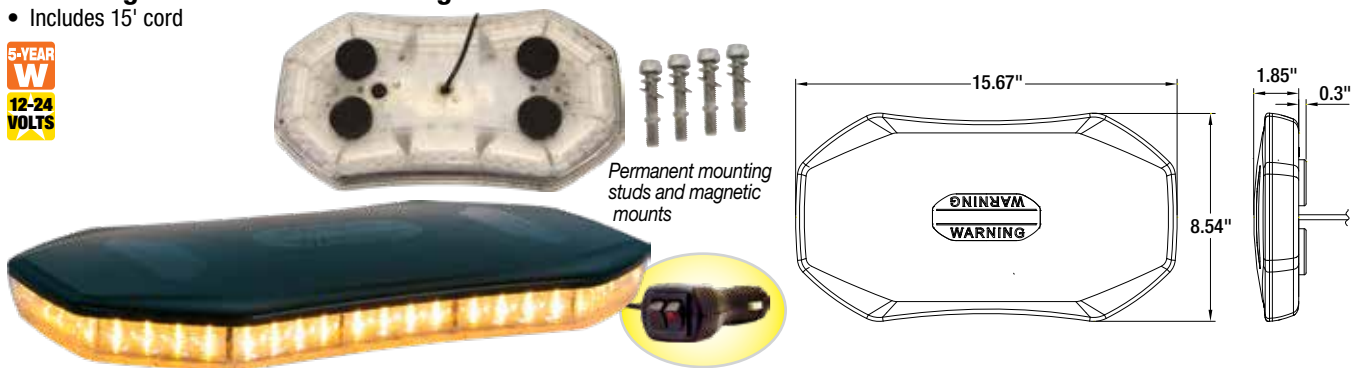

Part No.	Size	LEDs	Color	Amp	Mount	Power	Flash Patterns	Wt. (lbs.)	Cat.
8891110	15.75"L x 8.75"W x 1.87"H	56	Amber	3.52	Magnetic/Permanent	DC Adapter	10	4.65	889 (N)
8891111	15.75"L x 8.75"W x 1.87"H	56	Amber/Clear	3.52	Magnetic/Permanent	DC Adapter	10	4.65	889 (N)

See pg. C26 for Drill-Free Cab Mounts Options

16.5" Rectangular LED Mini Light Bar

- Includes 15' cord

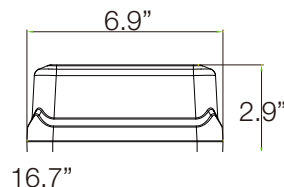

8891091-Permanent mounting studs and magnetic mounts



Part No.	Size	LEDs	Color	Amp	Mount	Power	Flash Patterns	Wt. (lbs.)	Cat.
8891090	16.7"L x 6.9"W x 2.9"H	18	Amber	3.2	Vacuum-Magnetic	DC Adapter	19 Patterns	7.78	889 (N)
8891091	Optional: Aluminum Light Bar Mounting Bracket Kit							1.70	889 (N)
	See pg. C26 for Drill-Free Cab Mounts Options							1.70	889 (N)

17" Octagonal Mini Light Bar

- Includes 15' cord

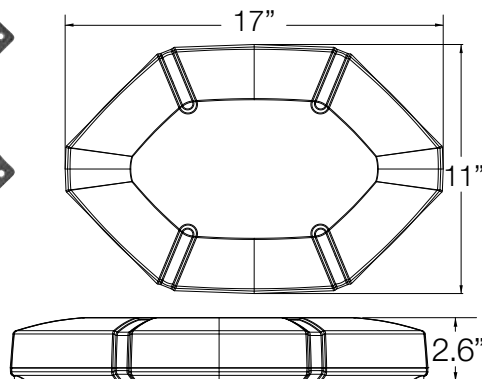
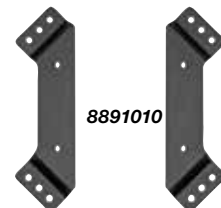

Part No.	Size	LEDs	Color	Amp	Mount	Power	Flash Patterns	Wt. (lbs.)	Cat.
8891100	16.75"L x 11"W x 2.75"H	30	Amber	3.6	Magnetic	DC Adapter	25	9.9	889 (N)
8891102*	16.75"L x 11"W x 2.75"H	30	Amber/Clear	3.6	Magnetic	DC Adapter	25	9.9	889 (N)
8891010	Optional: Aluminum Mounting Brackets for Octagonal Mini Light Bars							0.70	889 (N)

* 8891102 is not SAE J895 Class 1

See pg. C26 for Drill-Free Cab Mount Options

Fleet Series Drill-Free Light Bar Cab Mount

- One piece construction
- Mounts in 3rd brake light OEM location.
- Aluminum construction with a black powder-coat finish
- Pre-drilled for Buyers mini light bars
- 30 lb. capacity
- 22"L x 10"W x 3.74"H



Part No.	Description	Wt. (lbs.)	Cat.
8895550	For Ford F-150 (2015+) and Ford F-250/550 (2017+)	1.58	889 (N)

LED Directional, Dashboard Light Bars and Cab Mounts

Drill-Free Light Bar Cab Mount

- Ideal for aluminum cabs
- Mounts in 3rd brake light OEM location
- Powder-coated aluminum platform
- 30 lb. capacity
- 22"L x 10"W x 1.5"H



Note: Third brake light not included, OEM light transfers

8895400

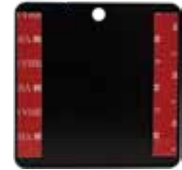

Note: Allows use of magnetic light mounts even on aluminum truck cabs

Part No.	Description	Wt. (lbs.)	Cat.
8895095	For Chevy-GMC 1500-3500 Cab & Chassis (2007-2013)	7.25	889 (N)
8895100	For Chevy-GMC 1500-3500 Pickup & Chassis (2014-2016)	7.25	889 (N)
8895105	Colorado/Canyon with/base "103" antenna	7.25	889 (N)
8895150	For Aluminum Cabs- Ford F-150 (2015+) and F-250/550 (2017+)	7.25	889 (N)
8895250	Light Bar Mount For F-250/550 Steel cab pickup and chassis (2006-2016)	7.25	889 (N)
8895300	For Ram-Dodge 1500-3500 Pickup & Chassis (2010-2016)	7.25	889 (N)
8895350	For 5500 Cab Chassis Ram-Dodge (2010-2016)	7.25	889 (N)
8895400	Self Adhesive Magnetic Mount Pad for Aluminum Cabs, Single	0.27	889 (N)
8895404	Self Adhesive Magnetic Mount Pad for Aluminum Cabs, 4 pack	1.02	889 (N)

LED Traffic Advisor/Strobe

5-YEAR
WARRANTY
12-24
VOLTS
IP
67

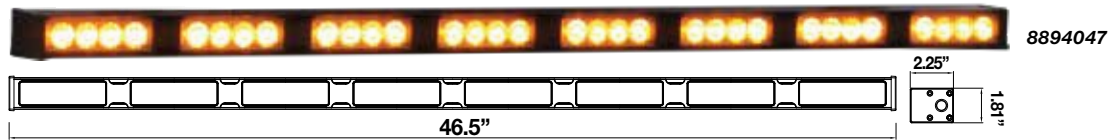

Adjustable width mounting studs

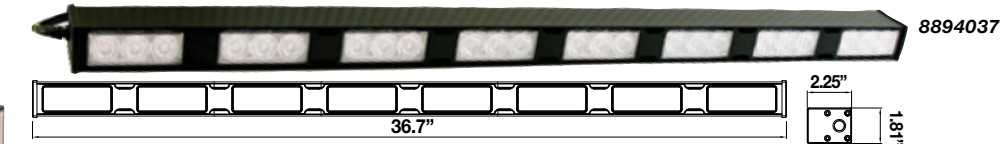

8894050 Riser Mounts



6391204



6391207

Part No.	Size	LEDs	Color	Amp	Power	Flash	Cable	Wt. (lbs.)	Cat.
8894037*	36.7"L x 2.25"W x 1.81"H	24	Amber	3.2	12-24 VDC	22 Flash Patterns; 11 Strobe/11 Traffic	25'	6.6	889 (N)
8894047*	46.5"L x 2.25"W x 1.81"H	32	Amber	3.2	12-24 VDC	22 Flash Patterns; 11 Strobe/11 Traffic	25'	7.5	889 (N)
8894050	Optional L-Bracket Riser Mounts - 4.3" H							0.5	889 (N)
8894055	8-Strand Bulk Wire, 25ft, For 8894037 & 8894047							2.25	560 (N)
8894056	8-Strand Bulk Wire, 50ft, For 8894037 & 8894047							4.5	560 (N)
6391204	Switch Panel, (3) On/Off, (1) Momentary							0.27	639 (N)
6391207	Switch Panel, (4) On/Off, (2) Momentary							0.39	639 (N)

* Also works with 6391208 and 6391209 shown on pg C21

14" LED Dashboard Light Bar

- Mounts with suction cups or adhesive hook with velcro

12-24
VOLTS



8891024



891025

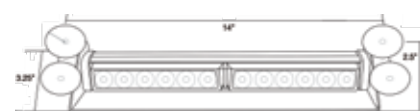

Part No.	Size	LEDs	Color	Amp	Mount	Power	Flash Patterns	Wt. (lbs.)	Cat.
8891024	14"L x 3.25"W x 2.5"H	12	Amber	0.35	Multiple	DC Adapter	19	1.58	889 (N)
8891025	14"L x 3.25"W x 2.5"H	12	Amber/Clear	0.35	Multiple	DC Adapter	19	1.58	889 (N)

Ultra-Thin 3.5" LED Strobe Light Series



- Includes 3M™ Self Adhesive Tape

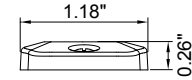
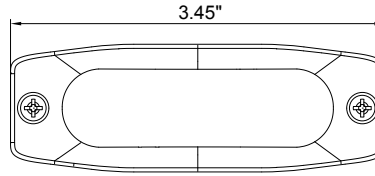

	Part No.	Size	LEDs	Color	Amp	Flash	Housing	Wt. (lbs.)	Cat	
		8892230	3.5"	3	Amber	0.5	12 Patterns	Aluminum	0.08	889 (N)
		8892231	3.5"	3	Clear	0.5	12 Patterns	Aluminum	0.08	889 (N)
		8892233	3.5"	3	Red	0.5	12 Patterns	Aluminum	0.08	889 (N)
		8892234	3.5"	3	Blue	0.5	12 Patterns	Aluminum	0.08	889 (N)
		8892239*	3.5"	3	Green	0.5	12 Patterns	Aluminum	0.08	889 (N)
		8892232	Black, 90 Degree Mounting Bracket						0.04	889 (N)

*8892239 is not CA13 or SAE J595 Class 1

Ultra Thin 4.5" LED Strobe Light



- Includes 3M™ Self Adhesive Tape

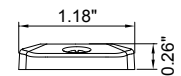
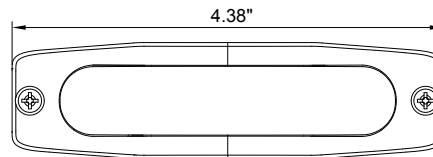

	Part No.	Size	LEDs	Color	Amp	Flash	Housing	Wt. (lbs.)	Cat.	
		8892240	4.4"	4	Amber	0.65	23 Patterns	Aluminum	0.10	889 (N)
		8892241	4.4"	4	Clear	0.65	23 Patterns	Aluminum	0.10	889 (N)
		8892242*	4.4"	4	Amber/Clear	0.65	23 Patterns	Aluminum	0.10	889 (N)
		8892243	4.4"	4	Red	0.65	23 Patterns	Aluminum	0.10	889 (N)
		8892244	4.4"	4	Blue	0.65	23 Patterns	Aluminum	0.10	889 (N)
		8892245*	4.4"	4	Red/Blue	0.65	23 Patterns	Aluminum	0.10	889 (N)
		8892246*	4.4"	4	Amber/Red	0.65	23 Patterns	Aluminum	0.10	889 (N)
		8892247*	4.4"	4	Clear/Red	0.65	23 Patterns	Aluminum	0.10	889 (N)
		8892248*	4.4"	4	Amber/Blue	0.65	23 Patterns	Aluminum	0.10	889 (N)
		8892249*	4.4"	4	Green	0.65	23 Patterns	Aluminum	0.10	889 (N)
		8892250*	4.4"	4	Amber/Green	0.65	23 Patterns	Aluminum	0.10	889 (N)
		8892255	Black, 90 Degree Mounting Bracket						0.04	889 (N)

* These color combinations are not CA13 or SAE J595 Class 1

Ultra Thin Surface Mounted LED Strobe Lights

Ultra Thin 5" LED Strobe Light



- Includes 3M™ self adhesive tape

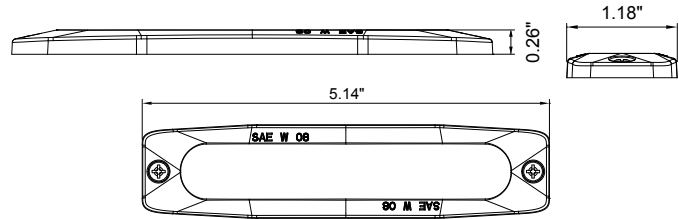

	Part No.	Size	LEDs	Color	Amp	Flash	Housing	Wt. (lbs.)	Cat.	
	8892200	5.14"	6	Amber	1.0	23 Patterns	Aluminum	0.09	889 (N)	
	8892201	5.14"	6	Clear	1.0	23 Patterns	Aluminum	0.09	889 (N)	
	8892202*	5.14"	6	Amber/Clear	1.0	23 Patterns	Aluminum	0.09	889 (N)	
	8892203	5.14"	6	Red	1.0	23 Patterns	Aluminum	0.09	889 (N)	
	8892204	5.14"	6	Blue	1.0	23 Patterns	Aluminum	0.09	889 (N)	
	8892205*	5.14"	6	Red/Blue	1.0	23 Patterns	Aluminum	0.09	889 (N)	
	8892206*	5.14"	6	Amber/Red	1.0	23 Patterns	Aluminum	0.09	889 (N)	
	8892207*	5.14"	6	Clear/Red	1.0	23 Patterns	Aluminum	0.09	889 (N)	
	8892208*	5.14"	6	Amber/Blue	1.0	23 Patterns	Aluminum	0.09	889 (N)	
	8892209*	5.14"	6	Green	1.0	23 Patterns	Aluminum	0.09	889 (N)	
	8892210*	5.14"	6	Amber/Green	1.0	23 Patterns	Aluminum	0.09	889 (N)	
	8892225	Black Mounting Bracket for Surface Mount Ultra-Thin LED Strobe Lights							0.07	889 (N)

*These color combinations are not CA13 or SAE J595 Class 1

Ultra Thin Wide Angle 5" LED Strobe Light



- Surface mount
- All mounting hardware included

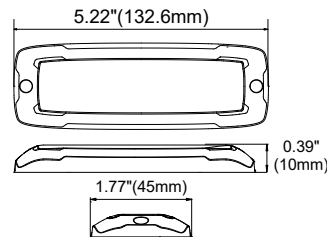

	Part No.	Size	LEDs	Color	Amp	Flash	Housing	Wt. (lbs.)	Cat.	
	8890300	5.2"	12	Amber	.88	16	Aluminum	.24	889 (N)	
	8890301	5.2"	12	Clear	.88	16	Aluminum	.24	889 (N)	
	8890302*	5.2"	12	Amber/Clear	.88	26	Aluminum	.24	889 (N)	
	8890305*	5.2"	12	Red/Blue	.88	26	Aluminum	.24	889 (N)	
	8890306*	5.2"	12	Amber/Red	.88	26	Aluminum	.24	889 (N)	
	8890307*	5.2"	12	Clear/Red	.88	26	Aluminum	.24	889 (N)	
	8890308*	5.2"	12	Amber/Blue	.88	26	Aluminum	.24	889 (N)	
	8890310*	5.2"	12	Amber/Green	.88	26	Aluminum	.24	889 (N)	
	8890320	Chrome Bezel For 8890300 Series Strobe Lights							0.04	889 (N)
	8890321	White Bezel For 8890300 Series Strobe Lights							0.04	889 (N)

*These color combinations are not CA13 or SAE J595 Class 1

Thin 3.5" LED Strobe Light



Shown with optional bezel

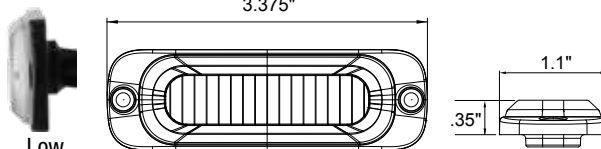

Low Profile

	Part No.	Size	LEDs	Color	Amp	Flash	Housing	Wt. (lbs.)	Cat.	
	8892300	3.375"	3	Amber	0.24	12 Patterns	Aluminum	0.11	889 (N)	
	8892301	3.375"	3	Clear	0.24	12 Patterns	Aluminum	0.11	889 (N)	
	8892303	3.375"	3	Red	0.24	12 Patterns	Aluminum	0.11	889 (N)	
	8892304	3.375"	3	Blue	0.24	12 Patterns	Aluminum	0.11	889 (N)	
	8892309*	3.375"	3	Green	0.24	12 Patterns	Aluminum	0.11	889 (N)	
	8892320	Chrome Bezel for 3-LED Thin Mount Strobe							0.11	889 (N)
	8892321	White Bezel for 3-LED Thin Mount Strobe							0.11	889 (N)
	8892325	Black, 90 Degree Mounting Bracket							0.04	889 (N)

*8892309 are not SAE J595 Class 1
Strobes must be mounted in horizontal position to achieve Class 1 rating

Thin 4.5" Horizontal LED Strobe Light



Low Profile

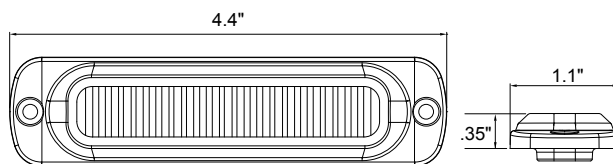

	Part No.	Size	LEDs	Color	Amp	Flash	Housing	Wt. (lbs.)	Cat.	
	8891900	4.5"	6	Amber	1.0	19 Patterns	Aluminum	.15	889 (N)	
	8891901	4.5"	6	Clear	1.0	19 Patterns	Aluminum	.15	889 (N)	
	8891902*	4.5"	6	Amber/Clear	1.0	19 Patterns	Aluminum	.15	889 (N)	
	8891903	4.5"	6	Red	1.0	19 Patterns	Aluminum	.15	889 (N)	
	8891904	4.5"	6	Blue	1.0	19 Patterns	Aluminum	.15	889 (N)	
	8891909*	4.5"	6	Green	1.0	19 Patterns	Aluminum	.15	889 (N)	
	8891920	Chrome bezel for thin mount LED Lights							0.02	889 (N)
	8891921	White PVC bezel for thin mount LED lights							0.03	889 (N)
	8891925	Black, 90 Degree Mounting Bracket							0.06	889 (N)

*8891902 and 8891909 are not SAE J595 Class 1
Strobes must be mounted in horizontal orientation to achieve Class 1 rating

Surface Mounted LED Strobe Lights

Thin 4.5" Vertical LED Strobe Light

5-YEAR W 12-24 VOLTS SAE J599 CLASS 1 IP 67

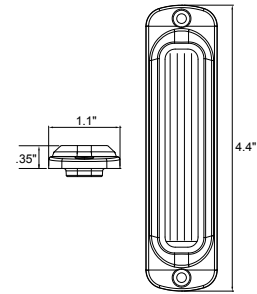

Shown with optional bezel

Part No.	Size	LEDs	Color	Amp	Flash	Housing	Wt. (lbs.)	Cat.	
8891910	4.5"	6	Amber	1.0	19 Patterns	Aluminum	.15	889 (N)	
8891911	4.5"	6	Clear	1.0	19 Patterns	Aluminum	.15	889 (N)	
8891912*	4.5"	6	Amber/Clear	1.0	19 Patterns	Aluminum	.15	889 (N)	
8891913	4.5"	6	Red	1.0	19 Patterns	Aluminum	.15	889 (N)	
8891914	4.5"	6	Blue	1.0	19 Patterns	Aluminum	.15	889 (N)	
8891919*	4.5"	6	Green	1.0	19 Patterns	Aluminum	.15	889 (N)	
8891920	Chrome Bezel for Thin Mount LED Lights							0.02	889 (N)
8891921	White PVC Bezel for Thin Mount LED Lights							0.03	889 (N)
8891925	Aluminum, 90 Degree Mounting Bracket							0.06	889 (N)

Strobes must be mounted in vertical orientation to achieve Class 1 rating

*These color combinations are not SAE J595 Class 1

3.5" LED Strobe Light

5-YEAR W 12-24 VOLTS SAE J599 CLASS 2 IP 67

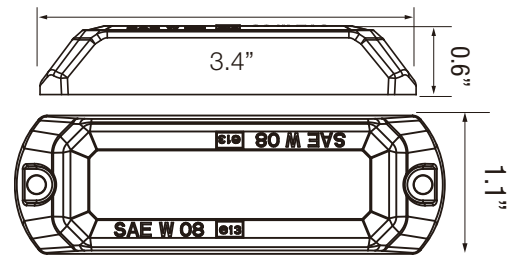

Part No.	Size	LEDs	Color	Amp	Flash	Housing	Wt. (lbs.)	Cat.
8891400	3.5"	3	Amber	0.22	12 Patterns	Aluminum	0.17	889 (N)
8891401	3.5"	3	Clear	0.22	12 Patterns	Aluminum	0.17	889 (N)
8891402	Black, 90 Degree Mounting Bracket for 8891400 and 8891401						0.08	889 (N)
8891405	Black Grommet for Recessed Mounting, 3-3/8"						0.038	889 (N)

2.5" LED Strobe Light

5-YEAR W 12-24 VOLTS SAE J599 CLASS 2 IP 67

• Multi-mount included



Part No.	Size	LEDs	Color	Amp	Flash	Housing	Wt. (lbs.)	Cat.
8891403	2.5"	3	Amber	0.22	12 Patterns	Aluminum	0.33	889 (N)
8891404	2.5"	3	Clear	0.22	12 Patterns	Aluminum	0.33	889 (N)

Stick-On 2.5" LED Strobe Light

5-YEAR W 12-24 VOLTS IP 66

- Can synchronize up to 6 lights



Low Profile

	Part No.	Size	LEDs	Color	Amp	Flash	Housing	Wt. (lbs.)	Cat.
	8892500	2.5"	6	Amber	0.30	1 Pattern	Plastic	0.09	889 (N)

4" LED Strobe Light

5-YEAR W 12-24 VOLTS SAE J595 CLASS 1 IP 67

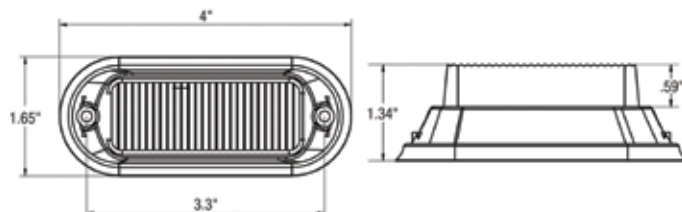

	Part No.	Size	LEDs	Color	Amp	Flash	Housing	Wt. (lbs.)	Cat.	
	8891120	4"	3	Amber	0.3	19 Patterns	Plastic	0.20	889 (N)	
	8891121	4"	3	Clear	0.3	19 Patterns	Plastic	0.20	889 (N)	
	8891135	Mounting Bracket for 8891120/8891121, Black							0.08	889 (N)

5" LED Mini Strobe Light Series

5-YEAR W 12-24 VOLTS SAE J595 CLASS 1 IP 67

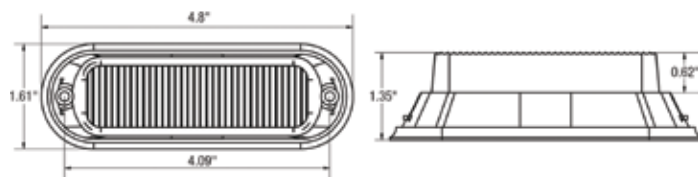

	Part No.	Size	LEDs	Color	Amp	Flash	Housing	Wt. (lbs.)	Cat.	
	8891130	4.8"	4	Amber	0.4	19 Patterns	Plastic	0.24	889 (N)	
	8891131	4.8"	4	Clear	0.4	19 Patterns	Plastic	0.24	889 (N)	
	8891132*	4.8"	4	Amber/Clear	0.4	19 Patterns	Plastic	0.24	889 (N)	
	8891135	Black, 90 Degree Mounting Bracket							0.04	889 (N)

* 8891132 is not CA13 or SAE J595 Class 1

Surface Mounted LED Strobe Lights

5" LED Strobe Light Series

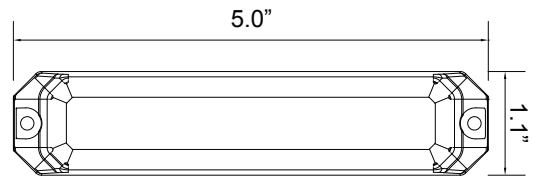

	Part No.	Size	LEDs	Color	Amp	Flash	Housing	Wt. (lbs.)	Cat.
	8891500	5"	6	Amber	1.1	19 Patterns	Aluminum	0.25	889 (N)
	8891501	5"	6	Clear	1.1	19 Patterns	Aluminum	0.25	889 (N)
	8891502*	5"	6	Amber/Clear	1.1	19 Patterns	Aluminum	0.25	889 (N)
	8891505	Grommet						0.25	889 (N)
	8891506	Black, 90 Degree Mounting Bracket						0.16	889 (N)

*8891502 is not CA13 or SAE J595 Class 1

5" Raised LED Strobe Light

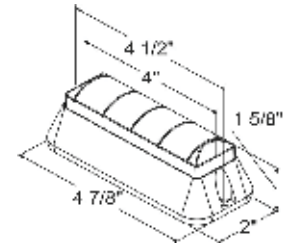

	Part No.	Size	LEDs	Color	Amp	Flash	Housing	Wt. (lbs.)	Cat.
	8891004	5"	4	Amber	0.54	1 Pattern	Aluminum	0.60	889 (N)
	8891006	5"	4	Clear	0.54	1 Pattern	Aluminum	0.60	889 (N)
	8891008	5"	4	Red	0.54	1 Pattern	Aluminum	0.60	889 (N)
	8891009	5"	4	Blue	0.54	1 Pattern	Aluminum	0.60	889 (N)
	8891007	Aluminum, 90 Degree Mounting Bracket						0.16	889 (N)

5" Raised LED Strobe Light



- Features alternating and synchronous functions

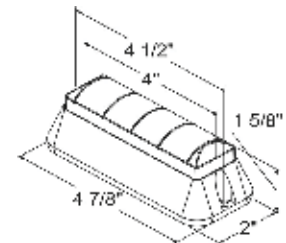

	Part No.	Size	LEDs	Color	Amp	Flash	Housing	Wt. (lbs.)	Cat.
	8891104	5"	4	Amber	0.54	19 Flash Patterns	Aluminum	0.60	889 (N)
	8891105*	5"	4	Amber/Clear	0.54	19 Flash Patterns	Aluminum	0.60	889 (N)
	8891007	Aluminum, 90 Degree Mounting Bracket						0.16	889 (N)

*8891105 is not SAE J595 Class 2

Narrow Profile 5" LED Strobe Light



- Mounts in the narrow spacing in a vehicle's front grill or between the rear bumper and tailgate of pickup trucks
- Includes mounting hardware

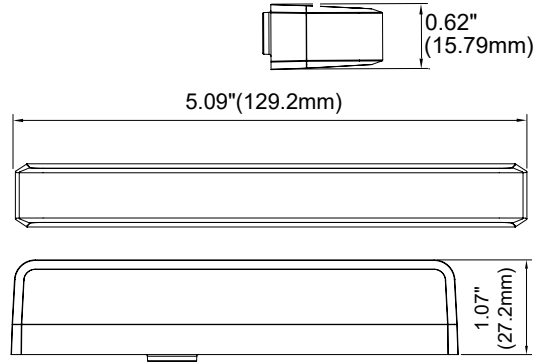

	Part No.	Size	LEDs	Color	Amp	Flash	Housing	Wt. (lbs.)	Cat.	
		8892700	5"	3	Amber	0.74	12 Patterns	Aluminum	0.29	889 (N)
		8892701	5"	3	Clear	0.74	12 Patterns	Aluminum	0.29	889 (N)
		8892703	5"	3	Red	0.74	12 Patterns	Aluminum	0.29	889 (N)
		8892704	5"	3	Blue	0.74	12 Patterns	Aluminum	0.29	889 (N)
		8892709*	5"	3	Green	0.74	12 Patterns	Aluminum	0.29	889 (N)

*Strobes must be mounted in correct orientation to achieve Class 1 rating
8892709 is not CA13 or SAE J595 Class 1

Ultra Bright Narrow Profile 5" LED Strobe Light



- Narrow .62 in. profile fits tight spaces
- Mounting hardware and brackets are included

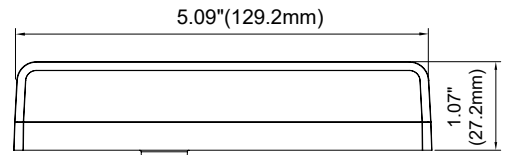

	Part No.	Size	LEDs	Color	Amp	Flash	Housing	Wt. (lbs.)	Cat.	
		8892800	5"	6	Amber	1.14	23 Patterns	Aluminum	0.29	889 (N)
		8892801	5"	6	Clear	1.14	23 Patterns	Aluminum	0.29	889 (N)
		8892802	5"	6	Amber/Clear	1.14	23 Patterns	Aluminum	0.29	889 (N)
		8892805	5"	6	Red/Blue	1.14	23 Patterns	Aluminum	0.29	889 (N)
		8892809*	5"	6	Green	1.14	23 Patterns	Aluminum	0.29	889 (N)
		8892810	5"	6	Amber/Green	1.14	23 Patterns	Aluminum	0.29	889 (N)

*Strobes must be mounted in vertical orientation to achieve Class 1 rating
8892809 is not SAE J595 Class 1

Dual Row Surface Mounted LED Strobe Lights

Thin Dual Row 4.5" LED Strobe Light

5-YEAR W 12-24 VOLTS SAE J595 CLASS 1 IP X8

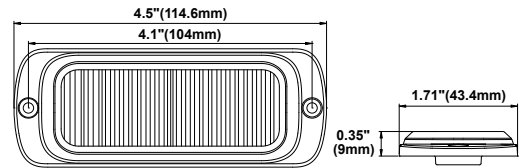

	Part No.	Size	LEDs	Color	Amp	Flash	Housing	Wt. (lbs.)	Cat.	
	8892600	4.5"	12	Amber	0.78	25 Patterns	Aluminum	0.21	889 (N)	
	8892602*	4.5"	12	Amber/Clear	0.78	25 Patterns	Aluminum	0.21	889 (N)	
	8892609*	4.5"	12	Green	0.78	25 Patterns	Aluminum	0.21	889 (N)	
NEW	8892620	Chrome Bezel for Thin Mount Rectangular Strobes						0.02	889 (N)	889 (N)

*These color combinations are not J595 Class 1

Dual Row 5" LED Strobe Light

5-YEAR W 12-24 VOLTS SAE J595 CLASS 1 IP 67 CA 13

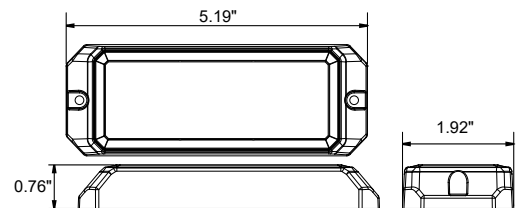

	Part No.	Size	LEDs	Color	Amp	Flash	Housing	Wt. (lbs.)	Cat.	
	8891700	5.19"	12	Amber	2.2	25 Patterns	Aluminum	0.42	889 (N)	
	8891701	5.19"	12	Clear	2.2	25 Patterns	Aluminum	0.42	889 (N)	
	8891702*	5.19"	12	Amber/Clear	2.2	25 Patterns	Aluminum	0.42	889 (N)	
	8891703	5.19"	12	Red	2.2	25 Patterns	Aluminum	0.42	889 (N)	
	8891704	5.19"	12	Blue	2.2	25 Patterns	Aluminum	0.42	889 (N)	
	8891707*	5.19"	12	Blue/Red	2.2	25 Patterns	Aluminum	0.42	889 (N)	
	8891709*	5.19"	12	Amber/Green	2.2	25 Patterns	Aluminum	0.42	889 (N)	
NEW	8891710*	5.19"	12	Green	2.2	25 Patterns	Aluminum	0.42	889 (N)	
	8891705	Recessed Mount, Black Grommet for 8891701 & 8891702							0.12	889 (N)
	8891706	Black, 90 Degree Mounting Bracket							0.70	889 (N)

*These color combinations are not CA13 or SAE J595 Class 1

Dual Row 5.5" LED Strobe Light

5-YEAR W 12-24 VOLTS IP 67

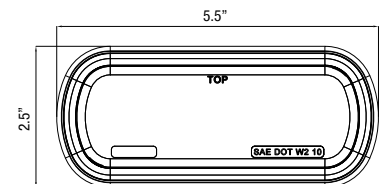

	Part No.	Size	LEDs	Color	Amp	Flash	Housing	Wt. (lbs.)	Cat.	
	8891600	5.5"	12	Amber	1.0	12 Patterns	Plastic	0.42	889 (N)	
	8891602*	5.5"	12	Amber/Clear	1.0	12 Patterns	Plastic	0.42	889 (N)	
	8891605	Aluminum, 90 Degree Mounting Bracket							0.16	889 (N)

*8891602 is not CA13 or SAE J595 Class 1

Triple Row 5.5" LED Strobe Light

5-YEAR W 12-24 VOLTS IP 67

- Features alternating and synchronous functions

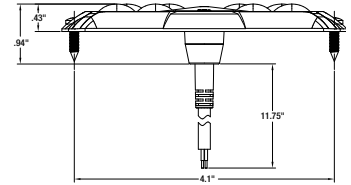
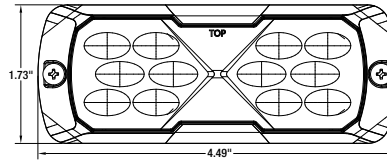

	Part No.	Size	LEDs	Color	Amp	Flash	Housing	Wt. (lbs.)	Cat.
NEW	8892900	4.5"	12	Amber	1.1	10 Patterns	Aluminum	0.42	889 (N)
NEW	8892902*	4.5"	12	Amber/Clear	1.1	5 Patterns	Aluminum	0.42	889 (N)

* 8892902 is not CA13 or SAE J595 Class 1

Post Mounted 3" LED Strobe Light

5-YEAR W 12-24 VOLTS SAE J595 CLASS 1 IP 67

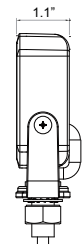
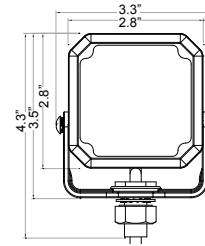

	Part No.	Size	LEDs	Color	Amp	Flash	Housing	Wt. (lbs.)	Cat.
NEW	8891800	2.85"	4	Amber	.55	19 Patterns	Aluminum	0.65	889 (N)

Post Mounted 4.5" LED Strobe Light

5-YEAR W 12-24 VOLTS IP 67

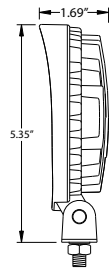
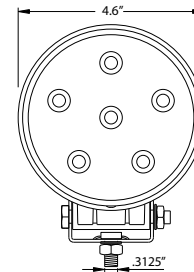

	Part No.	Size	LEDs	Color	Amp	Flash	Housing	Wt. (lbs.)	Cat.
NEW	8891015	4"	6	Amber	1.5	1 Pattern	Aluminum	1.20	889 (N)

Quad Row 5" LED Strobe Light

5-YEAR W 12-24 VOLTS SAE J595 CLASS 1 IP 67

- Includes synchronous and alternating functions

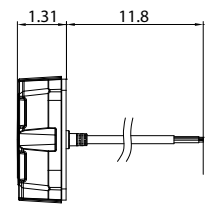
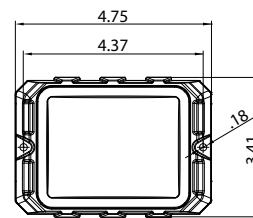

	Part No.	Size	LEDs	Color	Amp	Flash	Housing	Wt. (lbs.)	Cat.
NEW	8890200	4.75"	16	Amber	1.0	10 Patterns	Aluminum	0.76	889 (N)
NEW	8890202	4.75"	16	Amber/Clear	1.0	10 Patterns	Aluminum	0.76	889 (N)

Other Surface Mounted and Hidden LED Strobe Lights

LED Strobe/Marker Lights

5-YEAR W **12 VOLTS**

- Set of 5 includes adapter harness and flasher

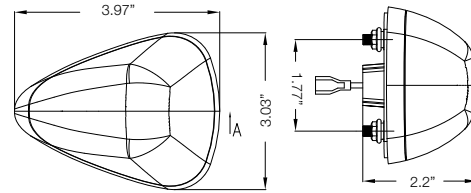



Part No.	LEDs	Color	Amp	Flash	Specifications	Wt. (lbs.)	Cat.
 8892000 (Set of 5)	9 per light	Amber	.36	13 Patterns	For 2008-2016 F-250 to F-750	2.30	889 (N)

Crush-Resistant LED Strobe Light Set

5-YEAR W **12 VOLTS** **IP 68**

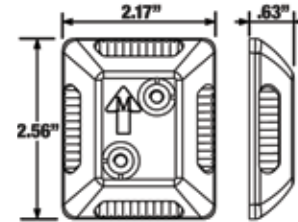
- Set of 2 strobes
- Includes 35' harness
- Gyro on/off Sensor
- 80 Flashes per minute
- Ideal for: liftgates, outriggers, body corners



Part No.	LEDs	Color	Amp	Flash	Housing	Wt. (lbs.)	Cat.
 8892110	8 per light	Amber	0.2	1 Pattern	Stainless Steel	1.6	889 (N)

Surface/Recess Mount LED Strobe Light Series

5-YEAR W **12 VOLTS** **SAE J599 CLASS 1** **CA 13**

- 1 lighthead per box



8892400
Shown with included bezel



Shown without bezel







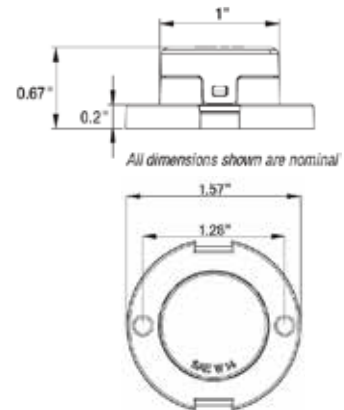

8892420
Sold separately



8892425
Sold separately



Part No.	Size	LEDs	Color	Amp	Flash	Housing	Wt. (lbs.)	Cat.
 8892400	1" round	3	Amber	.47	16 Patterns	Aluminum	0.10	889 (N)
 8892401	1" round	3	Clear	.47	16 Patterns	Aluminum	0.10	889 (N)
 8892403	1" round	3	Red	.47	16 Patterns	Aluminum	0.10	889 (N)
 8892404	1" round	3	Blue	.47	16 Patterns	Aluminum	0.10	889 (N)
 8892420	Chrome Bezel (Sold Separately)						0.10	889 (N)
 8892425	Black Aluminum Mounting Bracket, 90 Degree (Sold Separately)						0.05	889 (N)

Bolt-On Hidden LED Strobe Kits with In-Line Flashers

5-YEAR
W 12
VOLTS

- 2 lighthoods per kit



	Part No.	Size	LEDs	Color	Amp	Flash	Housing	Wt. (lbs.)	Cat.	
	8891215	15'	6	Clear	1.3	19 Patterns	Aluminum	1.25	889 (N)	
	8891225	25'	6	Clear	1.3	19 Patterns	Aluminum	1.60	889 (N)	
	8891216	15'	6	Amber	1.3	19 Patterns	Aluminum	1.25	889 (N)	
	8891226	25'	6	Amber	1.3	19 Patterns	Aluminum	1.60	889 (N)	
	8891227	25'	6	Amber/Clear	1.3	19 Patterns	Aluminum	1.60	889 (N)	
	8891200	1 Pair, Chrome, Surface Mount Bezels for Bolt-On Hidden Strobes							0.04	889 (N)
	8891201	1 Pair, Black, Surface Mount Bezels for Bolt-On Hidden Strobes							0.04	889 (N)

Note: Up to six 8891215-8891327 can be combined for synchronized or alternating flash patterns

Push-On Hidden Strobe Kit with In-Line Flashers

5-YEAR
W 12
VOLTS

- 2 lighthoods per kit
- 1 Pair surface mount bezel included



	Part No.	Size	LEDs	Color	Amp	Flash	Housing	Wt. (lbs.)	Cat.
	8891325	25'	6	Clear	1.3	19 Patterns	Aluminum	1.60	889 (N)
	8891326	25'	6	Amber	1.3	19 Patterns	Aluminum	1.60	889 (N)
	8891327	25'	6	Amber/Clear	1.3	19 Patterns	Aluminum	1.60	889 (N)

Note: Up to six 8891215-8891327 can be combined for synchronized or alternating flash patterns

4" Round LED Recessed Strobe Light

5-YEAR
W 12-24
VOLTS **IP 67**

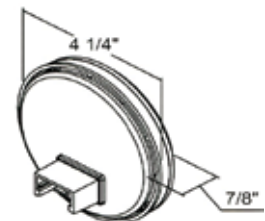

	Part No.	Size	LEDs	Color	Amp	Flash Pattern	Housing	Wt. (lbs.)	Cat.
	SL40AR	4"	24	Amber	0.50	Six Flash	Plastic	0.40	889 (N)
	SL40CR	4"	24	Clear	0.50	Six Flash	Plastic	0.40	889 (N)
	SL41AR	4"	24	Amber	0.50	Quad Flash, Alternating and Synchronized Patterns	Plastic	0.40	889 (N)

LED Recessed Strobes

6" Oval LED Recessed Strobe Light

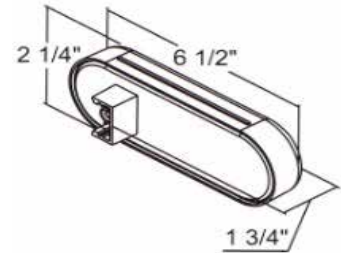

Part No.	Size	LEDs	Color	Amp	Flash Pattern	Housing	Wt. (lbs.)	Cat.
SL65AO	6"	24	Amber	0.50	Six Flash	Plastic	0.70	889 (N)
SL65CO	6"	24	Clear	0.50	Six Flash	Plastic	0.70	889 (N)

6" Quad Flash Oval Recessed Strobe Light Series



SL67AO



SL66AC

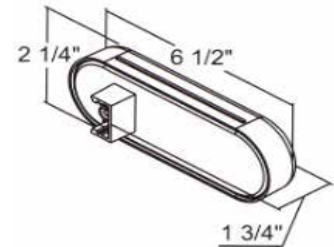

Part No.	Size	LEDs	Color	Amp	Flash Pattern	Housing	Wt. (lbs.)	Cat.
SL67AO	6"	19	Amber	2.0	Quad Flash, Alternating Patterns	Plastic	0.70	889 (N)
SL66AC*	6"	24	Amber/Clear	0.50	Quad Flash, Alternating and Synchronized Patterns	Plastic	0.70	889 (N)
SL66AG*	6"	24	Amber/Green	0.50	Quad Flash, Alternating and Synchronized Patterns	Plastic	0.70	889 (N)
SL66AO*	6"	24	Amber with Amber Lens	0.50	Quad Flash, Alternating and Synchronized Patterns	Plastic	0.70	889 (N)
SL66CA*	6"	24	Amber	0.50	Quad Flash, Alternating and Synchronized Patterns	Plastic	0.70	889 (N)
SL66CG*	6"	24	Clear/Green	0.50	Quad Flash, Alternating and Synchronized Patterns	Plastic	0.70	889 (N)
SL66GO*	6"	24	Green	0.50	Quad Flash, Alternating and Synchronized Patterns	Plastic	0.70	889 (N)

*These color combinations are not SAE J595 Class 1

6" Oval LED Recessed Strobe Light



- Includes synchronous and alternating functions

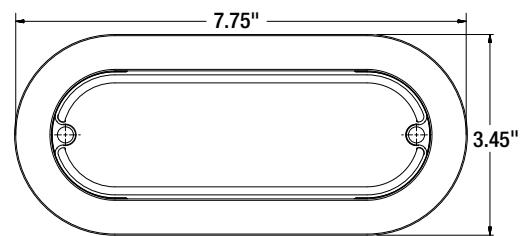

Part No.	Size	LEDs	Color	Amp	Flash Patterns	Housing	Wt. (lbs.)	Cat.
SL68AO	6"	56	Amber	0.50	19	Plastic	0.54	889 (N)
SL68AC	6"	56	Clear	0.50	19	Plastic	0.54	889 (N)

Low Profile 6" LED Beacon

5-YEAR W 12-24 VOLTS

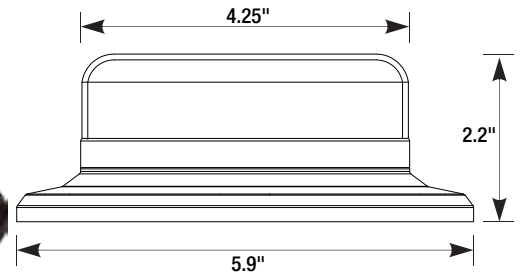

Part No.	Size	LEDs	Color	Amp	Flash Patterns	Mount	Cord	Wt. (lbs.)	Cat.
NEW SL550ALP	5.9" Diam x 2.2" T	12	Amber	1	3	Permanent and Magnetic	15' ON/OFF switch	1.46	889 (N)
NEW SL551ALP	5.9" Diam x 2.2" T	12	Amber	1	3	Permanent	13" blunt cut	1.08	889 (N)

Low Profile 8" LED Beacon

5-YEAR W 12-24 VOLTS SAE J848 CLASS 1 IP 67 CA 13

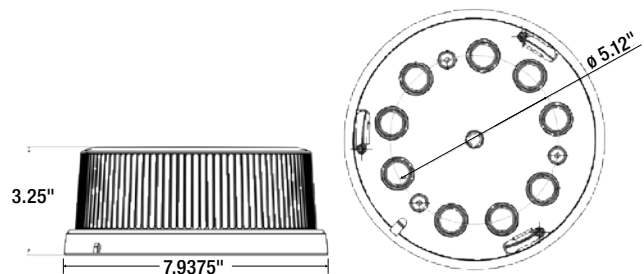

Part No.	Size	LEDs	Color	Amp	Flash	Mount	Cord	Wt. (lbs.)	Cat.
NEW SL700A	8" Diam x 3.25" T	15	Amber	2A	11	Permanent	10"	3.0	889 (N)

7" LED Beacon with Upward Facing LEDs

5-YEAR W 12-24 VOLTS SAE J848 CLASS 1 IP 67 CA 13

- 36 LEDs with 12 facing upwards
- Mount Styles: 3 Bolt or 1" Pipe Mount

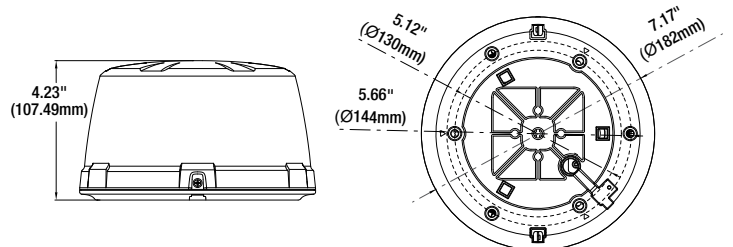

Part No.	Size	LEDs	Color	Amp	Flash	Mount	Cord	Wt. (lbs.)	Cat.
NEW SL800A	7.17" Diam x 4.25" T	36	Amber	5.56	14	Permanent	10"	2.88	889 (N)

5.5" x 4.5" LED Beacon

5-YEAR W 12-24 VOLTS SAE J848 CLASS 1 IP X6

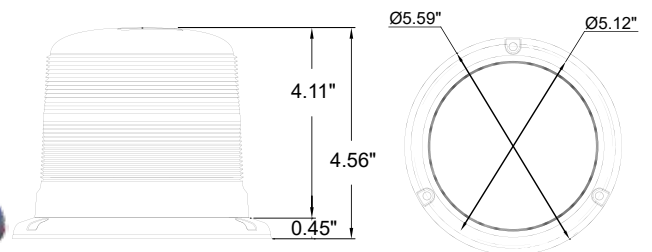

Part No.	Size	LEDs	Color	Amp	Flash Patterns	Mount	Cord	Wt. (lbs.)	Cat.
NEW SL585ALP	5.59" Diam x 4.56" T	15	Amber	1.86	11	Permanent 3-bolt mount	11" blunt cut	1.31	889 (N)
NEW SL585BLP	5.59" Diam x 4.56" T	15	Blue	1.86	11	Permanent 3-bolt mount	11" blunt cut	1.31	889 (N)

LED Beacon Lights

6.5" x 5" LED Beacon

5-YEAR WARRANTY
12-24 VOLTS
SAE J848 CLASS 1

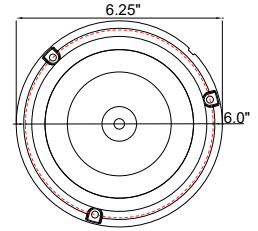
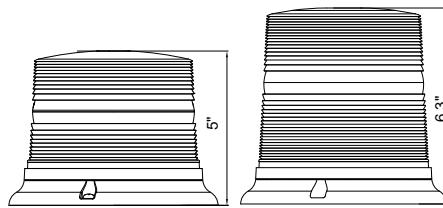

Part No.	Size	LEDs	Color	Amp	Flash Patterns	Mount	Cord	Wt. (lbs.)	Cat.
SL645ALP	6.25" Diam x 5" T	6	Amber	1.5	1	1" Pipe/3-Bolt Mount/Magnetic	10'	2.4	889 (N)
NEW SL665A	6.25" Diam x 6.3" T	6	Amber	1.5	1	1" Pipe/3-Bolt Mount/Magnetic	10'	2.7	889 (N)

6.5" x 5" LED Beacon

5-YEAR WARRANTY
12-24 VOLTS
SAE J848 CLASS 1

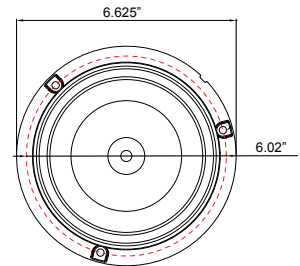
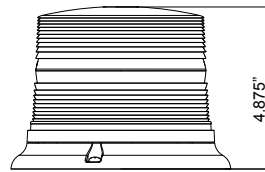

Part No.	Size	LEDs	Color	Amp	Flash	Mount	Cord	Wt. (lbs.)	Cat.
SL675ALP	6.625" Diam x 4.875" T	8	Amber	1.5	15 Flash Patterns	Magnetic	10'	2.65	889 (N)
SL685ALP	6.625" Diam x 4.875" T	8	Amber	1.5	15 Flash Patterns	1" Pipe/3-Bolt Mount	9'	1.63	889 (N)

6.5" x 6.5" LED Beacon

5-YEAR WARRANTY
12-24 VOLTS
SAE J848 CLASS 1
CA 13

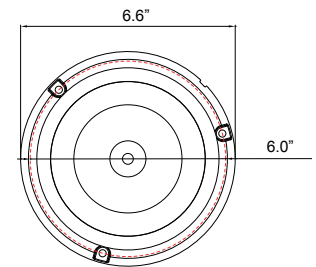
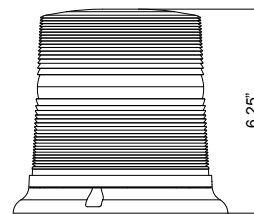

Part No.	Size	LEDs	Color	Amp	Flash	Mount	Cord	Wt. (lbs.)	Cat.
SL695A	6.25" Diam x 6.625" T, Auxiliary Plug	12	Amber	2.7	12 Flash Patterns	Magnetic	10'	2.67	889 (N)
SL696A	6.25" Diam x 6.625" T, Blunt Cut Ends	12	Amber	2.7	12 Flash Patterns	1" Pipe/3-Bolt Mount	12"	1.95	889 (N)

Smooth clear outer lens meets CA13 requirements

5" x 4" LED Beacon

5-YEAR WARRANTY
12-24 VOLTS
SAE J848 CLASS 1



Part No.	Size	LEDs	Color	Amp	Flash Patterns	Mount	Cord	Wt. (lbs.)	Cat.
NEW SL502A	5-1/8" Diam x 3-3/4" T	32	Amber	0.6	8	Magnetic and Permanent	10'	1.16	889 (N)

6.5" x 5" LED Beacon

5-YEAR
W 12-24
VOLTS SAE J848
CLASS 2

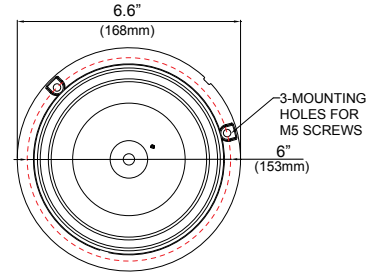
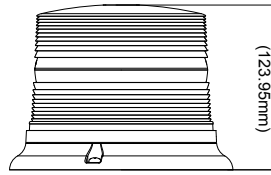

Part No.	Size	LEDs	Color	Amp	Flash	Mount	Cord	Wt. (lbs.)	Cat.
SL620ALP	6.25" Diam x 5" T	3	Amber	1.5	5 Flash	1" Pipe/3-Bolt Mount/Magnetic	10'	2.46	889 (N)

6.5" x 6.5" LED Beacon with Tall Lens

5-YEAR
W 12-24
VOLTS SAE J848
CLASS 2

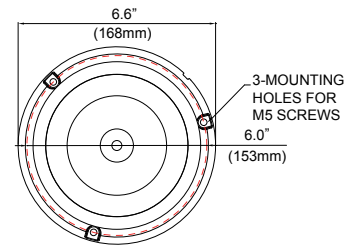
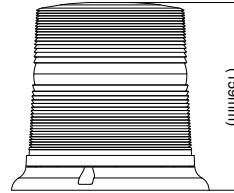

Part No.	Size	LEDs	Color	Amp	Flash	Mount	Cord	Wt. (lbs.)	Cat.
SL630A	6.25" Diam x 6.3" T	3	Amber	1.5		1" Pipe/3-Bolt Mount/Magnetic	10'	2.65	889 (N)

Portable 5" x 4" LED Beacon

5-YEAR
W

- 24 LEDs
- Requires 2 D-size batteries
- Automatic On/Off operation with light sensor or manual operation via selector switch
- Push button override

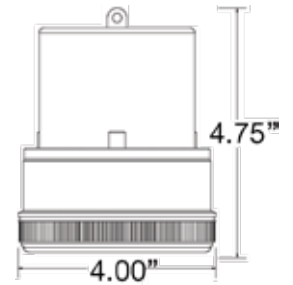

Part No.	Size	Color	Power	Mount	Cord	Wt. (lbs.)	Cat.	
SL475A	4" Diam x 4.75" T	Amber	2-D Batteries	Magnets	N/A	0.73	889 (N)	
3029961	Optional Galvanized Mounting Bracket						1.25	889 (N)

Portable 5.5" x 4.5" LED Beacon

5-YEAR
W 12-24
VOLTS

- 72 LEDs
- Built in power Switch
- Requires 4- AA batteries

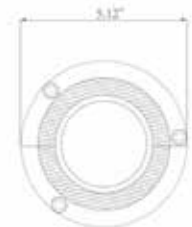

Part No.	Size	Color	Amp	Flash Patterns	Mount	Battery	Wt. (lbs.)	Cat.
NEW SL480A	5-1/2" Diam x 4-1/2" T	Amber	0.2	1	Magnetic	(4) AA	1.29	889 (N)

Beacon Strobe Lights

5" x 4" LED Beacon

5-YEAR
W **12-24**
VOLTS

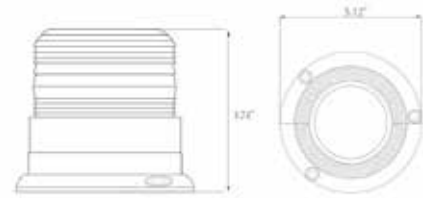

Part No.	Size	LEDs	Color	Amp	Flash Patterns	Mount	Cord	Wt. (lbs.)	Cat.
SL501A	5-1/8" Diam x 3-3/4" T	40	Amber	0.6	2	Magnetic and Permanent	10'	1.28	889 (N)

6" x 5" Incandescent Beacon Strobe

1-YEAR
W **12-110**
VOLTS

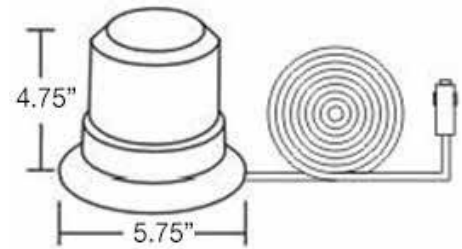

Part No.	Size	Joules	Color	Amp	Flash	Mount	Cord	Wt. (lbs.)	Cat.
SL650A	6" Diam x 4.75" T	1.7	Amber	0.3	1 FlashPattern	Magnetic and Permanent	10'	1.5	889 (N)

6.5" x 5" Incandescent Beacon Strobe

1-YEAR
W **12-24**
VOLTS

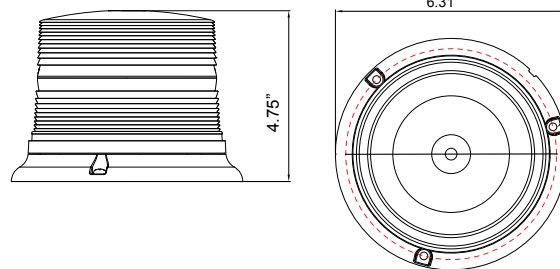

Part No.	Size	Joules	Color	Amp	Flash	Mount	Cord	Wt. (lbs.)	Cat.
SL640ALP	6.31" Diam x 4.75" T	8	Amber	1.5	1 Flash Pattern	1" Pipe/3-Bolt Mount	12"	1.75	889 (N)
3016342	Replacement Bulb							0.2	889 (N)

6.5" x 6.5" Incandescent Beacon Strobe

1-YEAR
W **12-24**
VOLTS

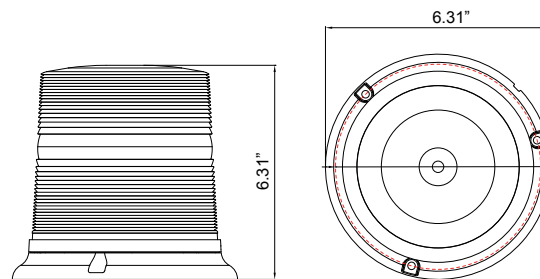

Part No.	Size	Joules	Color	Amp	Flash	Mount	Cord	Wt. (lbs.)	Cat.
SL660A	6.31" Diam x 6.31" T	8	Amber	1.5	Dual Flash 80 FPM	1" Pipe/3-Bolt Mount	10"	2.0	889 (N)
3016342	Replacement Bulb							.02	889 (N)

5.5" Halogen Revolving Light

1-YEAR
W
12-24
VOLTS

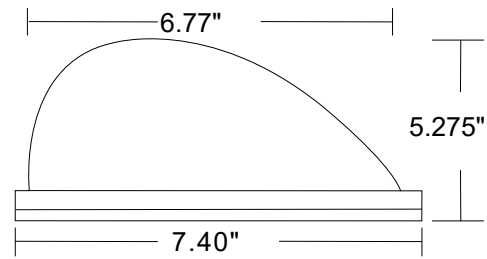

Part No.	Size	Color	Amp	Flash	Mount	Cord	Wt. (lbs.)	Cat.
 RL650A	7" Diam x 5.25" T	Amber	1.5	90 FPM	Magnetic	10'	1.5	889 (N)

5" x 4" Incandescent Beacon Strobe

1-YEAR
W
12-24
VOLTS

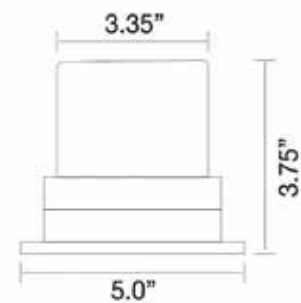

Part No.	Size	Joules	Color	Amp	Flash	Mount	Cord	Wt. (lbs.)	Cat.
 SL500A	5-1/8" Diam x 3-3/4" T	1.7	Amber	0.6	2 Flash Patterns	Magnetic and Permanent	10'	1.13	889 (N)

Beacon Mounting Brackets and Brush Guard



B210880



8891001



8891002



8891003



8895400

Part No.	Description	Size	Wt. (lbs.)	Cat.
B210880	Self leveling. Mounting Bracket, 3/16" Steel plate with black powder coating.	9"W (ID) x 7.625T (OD)	6.7	889 (N)
8891001	Beacon Mirror Mounting Bracket, Stainless Steel, Adjustable. Includes U-Bolts. Bolt Pattern Fits Most Beacons up to 6.625" diameter.	6.625" Diam x 4.875" T	1.4	889 (N)
8891002	Black Beacon Brush Guard. (See fit guide online at buyersproducts.com)	6.5" Diam x 6.5" T	1.0	889 (N)
8891003	Stainless Steel Beacon Mount Bracket	10.5"H x 6.88"L x 6.63"W	1.94	889 (N)
NEW 8895400	Self Adhesive, Magnetic Mount Pad for Aluminum Cabs, Single	3.5"H x 3.5"W	0.27	889 (N)
8895404	Bulk 8895400, 4 pack	3.5"H x 3.5"W	1.02	889 (N)



0.75" Round Marker/Clearance Lights

1 LED Kits



- Kits includes mount and grommet



Part No.	Size	LED's	Lens Color	Connection	Lead	Amp	Std. Qty.	Wt. (lbs.)	Cat.
5623413	.75"	1	Red	Hard Wired	.180 Male Bullets	0.021	10	0.03	562 (N)
5623414	.75"	1	Red	Hard Wired	Stripped Leads	0.021	10	0.02	562 (N)
5623423	.75"	1	Amber	Hard Wired	.180 Male Bullets	0.021	10	0.03	562 (N)
5623424	.75"	1	Amber	Hard Wired	Stripped Leads	0.021	10	0.02	562 (N)
5627511	.75"	1	Red	Hard Wired	.180 Male Bullets	0.021	10	0.05	562 (N)
5627512	.75"	1	Red	Hard Wired	Stripped Leads	0.021	10	0.05	562 (N)
5627521	.75"	1	Amber	Hard Wired	.180 Male Bullets	0.021	10	0.05	562 (N)
5627522	.75"	1	Amber	Hard Wired	Stripped Leads	0.021	10	0.02	562 (N)
5627532	.75"	1	Clear	Hard Wired	Stripped Leads	0.021	10	0.02	562 (N)

3 LEDs Kits



- Kits includes mount and grommet

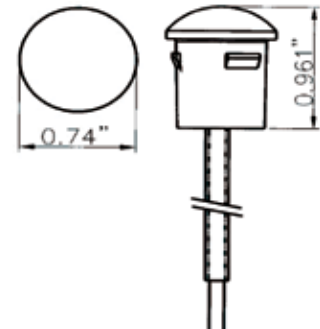

Part No.	Size	LED's	Lens Color	Connection	Lead	Amp	Std. Qty.	Wt. (lbs.)	Cat.
5627513	.75"	3	Red	Hard Wired	.180 Male Bullets	.038	10	0.05	562 (N)
5627514	.75"	3	Red	Hard Wired	Stripped Leads	.038	10	0.05	562 (N)
5627517	.75"	3	Red	Hard Wired	Stripped Leads	.038	1	0.05	562 (N)
5627523	.75"	3	Amber	Hard Wired	.180 Male Bullets	.038	10	0.05	562 (N)
5627524	.75"	3	Amber	Hard Wired	Stripped Leads	.038	10	0.05	562 (N)
5627527	.75"	3	Amber	Hard Wired	Stripped Leads	.038	1	0.05	562 (N)

Replacement Black Grommets for 0.75" Marker/Clearance Lights



Part No.	Size	Description	Std. Qty.	Wt. (lbs.)	Cat.
5627501	.75"	Black Grommet for .75" Round Marker Lights, for 1-LED Marker/Clearance Lights	25	0.05	562 (N)
5627503	.75"	Black Grommet for .75" Round Marker Lights, for 3-LED Marker/Clearance Lights	25	0.05	562 (N)

For plugs refer to **pg. C61**

2" and 2.5" Round Marker/Clearance Lights

2" Round Marker/Clearance Light Kit with 1 LED

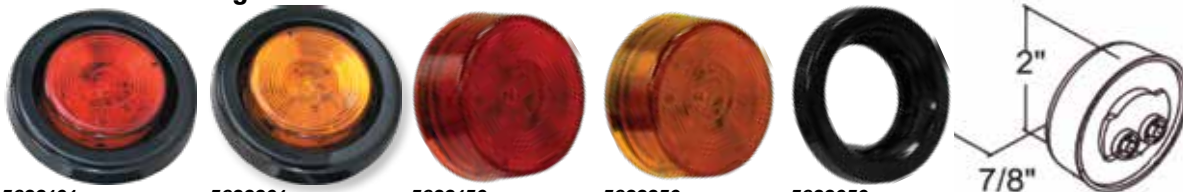

5622101 Plug and grommet included **5622201** Plug and grommet included **5622150** Light only (sold in qty of 10) **5622250** Light only (sold in qty of 10) **5622050** (sold in qty of 10)

Part No.	Size	LED's	Lens Color	Connection	Mounting	Amp	Std. Qty.	Wt. (lbs.)	Cat.	
5622101	2"	1	Red	PL-10 Connection	Grommet (Included)	.050	1	0.18	562 (N)	
5622201	2"	1	Amber	PL-10 Connection	Grommet (Included)	.050	1	0.18	562 (N)	
5622150	2"	1	Red	PL-10 Connection	Grommet	.050	10	0.07	562 (N)	
5622250	2"	1	Amber	PL-10 Connection	Grommet	.050	10	0.07	562 (N)	
5622050	2"	Round, Open Back, Flush Mount Grommet for use with 5622150, 5622250, 5622154, 5622254						10	0.07	562 (N)

2" Round Marker/Clearance Light with 4 LEDs



5622102 Plug and grommet included **5622202** Plug and grommet included **5622154** (sold in qty of 10) **5622254** (sold in qty of 10) **5622050** (sold in qty of 10)

Part No.	Size	LED's	Lens Color	Connection	Mounting	Amp	Std. Qty.	Wt. (lbs.)	Cat.	
5622102	2"	4	Red	PL-10 Connection	Grommet (Included)	.039	1	0.18	562 (N)	
5622202	2"	4	Amber	PL-10 Connection	Grommet (Included)	.039	1	0.18	562 (N)	
5622154	2"	4	Red	PL-10 Connection	Grommet	.039	10	0.07	562 (N)	
5622254	2"	4	Amber	PL-10 Connection	Grommet	.039	10	0.07	562 (N)	
5622050	2"	Round, Open Back, Flush Mount Grommet for use with 5622150, 5622250, 5622154, 5622254						10	0.07	562 (N)

2" Round Incandescent Marker Light



5652001 (sold in qty of 10) **5652002** (sold in qty of 10) **5622050** (sold in qty of 10)

Part No.	Size	Lens Color	Connection	Mounting	Amp	Std. Qty.	Wt. (lbs.)	Cat.		
5652001	2"	Red	PL-10 Connection	Grommet	0.33	10	0.04	562 (N)		
5652002	2"	Amber	PL-10 Connection	Grommet	0.33	10	0.04	562 (N)		
5622050	2"	Round, Open Back, Flush Mount Grommet for use with 5652001, 5652002						10	0.07	562(N)

2.5" Round Marker/Clearance Light with 2 LEDs



5622512 (sold in qty of 10) **5622522** (sold in qty of 10) **5622505** (sold in qty of 10) **5622506** (sold in qty of 10)

Part No.	Size	LED's	Lens Color	Connection	Mounting	Amp	Std. Qty.	Wt. (lbs.)	Cat.	
5622512	2.5"	2	Red	PL-10 Connection	Grommet	.044	10	0.11	562 (N)	
5622522	2.5"	2	Amber	PL-10 Connection	Grommet	.044	10	0.11	562 (N)	
5622505	2.5"	Round, Flush Mount, Semi-Open Back						10	0.11	562 (N)
5622506	2.5"	Round, Flush Mount, Open Back						10	0.11	562 (N)

For plugs refer to **pg. C61**

2.5" Round Marker/Clearance Lights

LIGHTS - DOT

2.5" Round Marker/Clearance Light with 4 LEDs



5622514
Plug and grommet included



5622524
Plug and grommet included



5622550
Light only (sold in qty of 10)



5622525
Light only (sold in qty of 10)



5622505
(sold in qty of 10)



5622506
(sold in qty of 10)

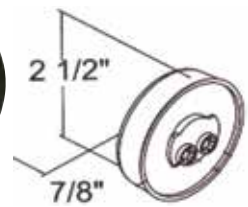

Part No.	Size	LED's	Lens Color	Connection	Mounting	Amp	Std. Qty.	Wt. (lbs.)	Cat.
5622514	2.5"	4	Red	PL-10 Connection	Grommet (Included)	.032	1	0.11	562 (N)
5622524	2.5"	4	Amber	PL-10 Connection	Grommet (Included)	.032	1	0.11	562 (N)
5622550	2.5"	4	Red	PL-10 Connection	Grommet	.032	10	0.11	562 (N)
5622525	2.5"	4	Amber	PL-10 Connection	Grommet	.032	10	0.11	562 (N)
5622505	2.5"	Round, Flush Mount, Semi-Open Back					10	0.11	562 (N)
5622506	2.5"	Round, Flush Mount, Open Back					10	0.11	562 (N)

2.5" Round Marker/Clearance Light with 7 LEDs



5622517
(sold in qty of 10)



5622527
(sold in qty of 10)



5622505
(sold in qty of 10)



5622506
(sold in qty of 10)

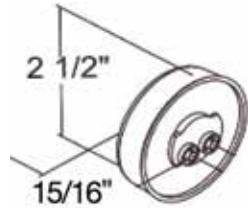

Part No.	Size	LED's	Lens Color	Connection	Mounting	Amp	Std. Qty.	Wt. (lbs.)	Cat.
5622517	2.5"	7	Red	PL-10 Connection	Grommet	.19	10	0.11	562 (N)
5622527	2.5"	7	Amber	PL-10 Connection	Grommet	.19	10	0.11	562 (N)
5622505	2.5"	Round, Flush Mount, Semi-Open Back					10	0.11	562 (N)
5622506	2.5"	Round, Flush Mount, Open Back					10	0.11	562 (N)

2.5" Round Marker/Clearance Light with Reflex and 4 LEDs



5622551
(sold in qty of 10)



5622526
(sold in qty of 10)



5622505
(sold in qty of 10)



5622506
(sold in qty of 10)

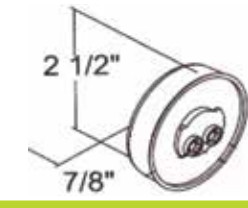

Part No.	Size	LED's	Lens Color	Connection	Mounting	Amp	Std. Qty.	Wt. (lbs.)	Cat.
5622551	2.5"	4	Red	PL-10 Connection	Grommet	.030	10	0.11	562 (N)
5622526	2.5"	4	Amber	PL-10 Connection	Grommet	.033	10	0.11	562 (N)
5622505	2.5"	Round, Flush Mount, Semi-Open Back					10	0.11	562 (N)
5622506	2.5"	Round, Flush Mount, Open Back					10	0.11	562 (N)

2.5" Round Incandescent Marker/Clearance Light



5652501
(sold in qty of 10)



5652502
(sold in qty of 10)



5622505
(sold in qty of 10)



5622506
(sold in qty of 10)

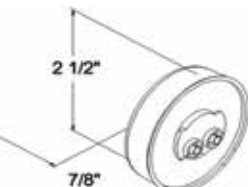

Part No.	Size	Lens Color	Connection	Mounting	Amp	Std. Qty.	Wt. (lbs.)	Cat.	
5652501	2.5"	Red	PL-10 Connection	Grommet	0.33	10	0.06	562 (N)	
5652502	2.5"	Amber	PL-10 Connection	Grommet	0.33	10	0.06	562 (N)	
5652501	2.5"	Round, Flush Mount, Semi-Open Back					10	0.11	562 (N)
5652502	2.5"	Round, Flush Mount, Open Back					10	0.11	562 (N)

For plugs refer to **pg. C61**

2.5" Round and 2.875" Rectangular Marker/Clearance Lights

2.5" Round Incandescent Marker/Clearance Light with Reflex



5652511
(sold in qty of 10)



5622512
(sold in qty of 10)



5622505
(sold in qty of 10)



5622506
(sold in qty of 10)

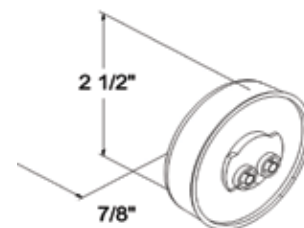

Part No.	Size	Lens Color	Connection	Mounting	Amp	Std. Qty.	Wt. (lbs.)	Cat.
5652511	2.5"	Red	PL-10 Connection	Grommet	0.33	10	0.06	562 (N)
5652512	2.5"	Amber	PL-10 Connection	Grommet	0.33	10	0.06	562 (N)
5622505	2.5"	Round, Flush Mount, Semi-Open Back				10	0.11	562 (N)
5622506	2.5"	Round, Flush Mount, Open Back				10	0.11	562 (N)

2.5" Surface Mount Marker Light with 3 LEDs



5622103
Plug and mounting bracket included



5622203
Plug and mounting bracket included

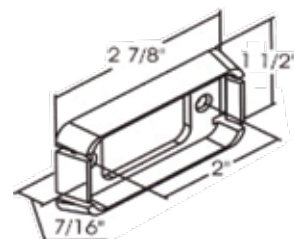

5622104
Light only (sold in qty of 10)



5622204
Light only (sold in qty of 10)



5622304
Light only (sold in qty of 10)



5622205
(sold in qty of 10)

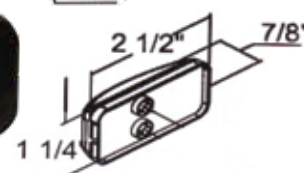

Part No.	Size	LED's	Lens Color	Connection	Mounting	Amp	Std. Qty.	Wt. (lbs.)	Cat.
5622103	2.5"	3	Red	PL-10 Connection	Surface Mount	.042	1	0.05	562 (N)
5622203	2.5"	3	Amber	PL-10 Connection	Surface Mount	.042	1	0.05	562 (N)
5622104	2.5"	3	Red	PL-10 Connection	Surface Mount	.042	10	0.05	562 (N)
5622204	2.5"	3	Amber	PL-10 Connection	Surface Mount	.042	10	0.05	562 (N)
5622304	2.5"	3	Clear	PL-10 Connection	Surface Mount	.042	10	0.05	562 (N)
5622205	2.5"	Flush Mount, Open Back Grommet for use with 5622104, 5622204, 5622304					10	0.11	562 (N)

2.875" Rectangular Marker/Clearance Light Kit with Reflex and 6 LEDs

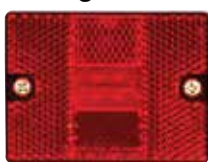

5622716
Includes ground wire
(sold in qty of 10)

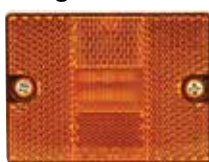

5622726
Includes ground wire
(sold in qty of 10)

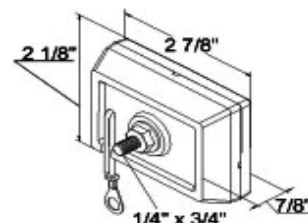

Part No.	Size	LED's	Lens Color	Connection	Mounting	Amp	Std. Qty.	Wt. (lbs.)	Cat.
5622716	2.875"	6	Red	Hard Wired with Stripped Lead and Ring Terminal	Stud	.033	10	0.14	562 (N)
5622726	2.875"	6	Amber	Hard Wired with Stripped Lead and Ring Terminal	Stud	.033	10	0.14	562 (N)

2.875" Rectangular Incandescent Marker Light with Reflex



5652720
(sold in qty of 10)

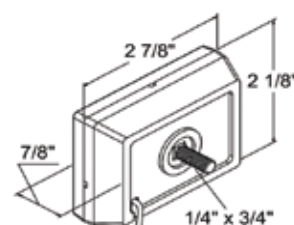

Part No.	Size	Lens Color	Connection	Mounting	Amp	Std. Qty.	Wt. (lbs.)	Cat.
5652720	2.875"	Amber	Hard Wired with Stripped Leads	Stud	0.33	10	0.10	562 (N)

For plugs refer to pg. C61

- Ground through stud



Products are Retail Packaged



DOT LED Marker Lights

3.125" Rectangular Marker/Clearance Light Kit with Reflex and 2 LEDs



5623112
Plug and grommet included



5623122
Plug and grommet included



5623113
Light only (sold in qty of 10)

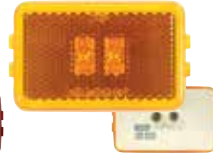

5623123
Light only (sold in qty of 10)



5623050
(sold in qty of 10)

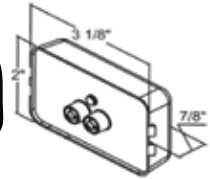

Part No.	Size	LED's	Lens Color	Connection	Mounting	Amp	Std. Qty.	Wt. (lbs.)	Cat.
5623112	3.125"	2	Red	PL-10 Connection	Grommet (Included)	.044	1	0.05	562 (N)
5623122	3.125"	2	Amber	PL-10 Connection	Grommet (Included)	.044	1	0.05	562 (N)
5623113	3.125"	2	Red	PL-10 Connection	Grommet	.044	10	0.08	562 (N)
5623123	3.125"	2	Amber	PL-10 Connection	Grommet	.044	10	0.08	562 (N)
5623050	3.125"	Recessed Mount Black Grommet for use with 5623113, 5623123					10	0.05	562 (N)

3.75" Rectangular Marker/Clearance Light with 2 LEDs



5623711
Plug and mounting bracket included (sold in qty of 10)



5623712
Light only (sold in qty of 10)



5623812
Light only (sold in qty of 10)



5623822
Light only (sold in qty of 10)

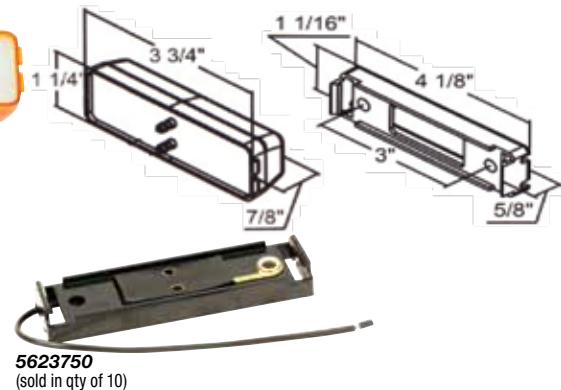

Part No.	Size	LED's	Lens Color	Connection	Mounting	Amp	Std. Qty.	Wt. (lbs.)	Cat.
5623711	3.75"	2	Amber/Red	Male Barrel Terminals	Surface Mount	.085	10	0.05	562 (N)
5623712	3.75"	2	Amber/Red	Male Barrel Terminals	Surface Mount	.085	10	0.05	562 (N)
5623812	3.875"	2	Red	Male Barrel Terminals	Surface Mount	.060	10	0.04	562 (N)
5623822	3.875"	2	Amber	Male Barrel Terminals	Surface Mount	.060	10	0.04	562 (N)
5623750	3.75"	Black Mounting Bracket Includes Stripped Lead						0.05	562 (N)

3.75" Rectangular Incandescent Marker/Clearance Light



5653701
(sold in qty of 10)



5653702
(sold in qty of 10)



5623750
(sold in qty of 10)

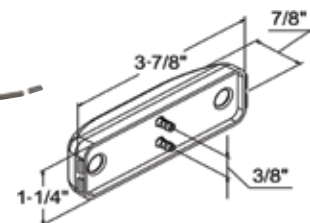

Part No.	Size	Lens Color	Connection	Mounting	Amp	Std. Qty.	Wt. (lbs.)	Cat.
5653701	3.75"	Red	Male Barrel Terminals	Surface	0.33	10	0.06	562 (N)
5653702	3.75"	Amber	Male Barrel Terminals	Surface	0.33	10	0.06	562 (N)
5623750	3.75"	Black Mounting Bracket Includes Stripped Lead					0.06	562 (N)

For plugs refer to **pg. C61**

0.75" ID Light Kit with 9 LEDs



5627533

Part No.	Size	LED's	Lens Color	Connection	Mounting	Amp	Std. Qty.	Wt. (lbs.)	Cat.
5627533	.75"	9	Red	Hard Wired with .180 Male Bullets	Grommet	.113	1	0.50	562 (N)

Stainless Steel ID Bar Light with 9 LEDs

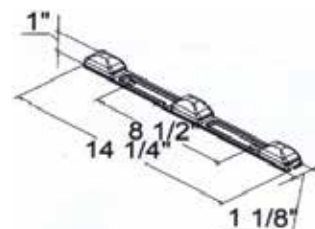

Part No.	Size	LED's	Lens Color	Connection	Mounting	Amp	Std. Qty.	Wt. (lbs.)	Cat.
5621720	14"	9	Red	Hard Wired with Stripped Lead and Ring Terminal	Surface	.147	1	0.55	562 (N)

17" Polycarbonate ID Bar Light with 9 LEDs

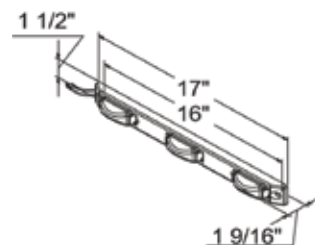

Part No.	Size	LED's	Lens Color	Connection	Mounting	Amp	Std. Qty.	Wt. (lbs.)	Cat.
5621719	17"	9	Red	Hard Wired with Stripped Lead and Ring Terminal	Surface	.119	1	0.65	562 (N)

17" Incandescent Polycarbonate ID Bar

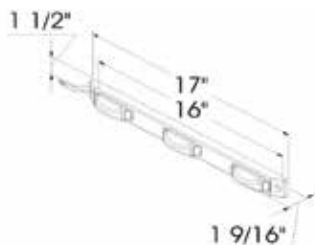

Part No.	Size	LED's	Lens Color	Connection	Mounting	Amp	Std. Qty.	Wt. (lbs.)	Cat.
5651700	17"	Red	Hard Wired with Stripped Lead and Ring Terminal	Surface	0.33	10	0.34	562 (N)	

17" Slimline Stop/Turn/Tail Light with 11 LEDs

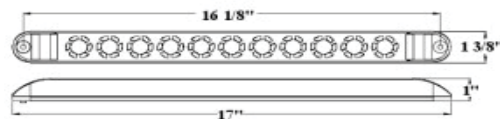

Part No.	Size	LED's	Lens Color	Connection	Mounting	Amp	Std. Qty.	Wt. (lbs.)	Cat.
5621711	17"	11	Red	Hard Wired with Stripped Leads & Ring Terminal	Surface	.162	10	0.41	562 (N)

For plugs refer to pg. C61



Products are Retail Packaged



4" Round Stop, Turn & Tail Lights

4" Round Stop/Turn/Tail Light with 1 LED



5624101
(sold in qty of 10)



5624050
(sold in qty of 10)

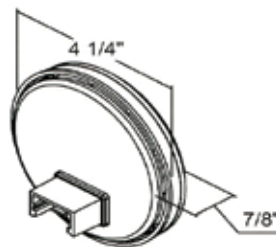

Part No.	Size	LED's	Lens Color	Connection	Mounting	Amp	Std. Qty.	Wt. (lbs.)	Cat.
NEW 5624101	4"	1	Red	PL-3 Connection	Grommet	.150	10	0.23	562 (N)
5624050	4"	Replacement Black Grommet					10	0.15	562 (N)

4" Round Stop/Turn/Tail Light with 7 LEDs



5624156
(sold in qty of 10)



5624050
(sold in qty of 10)

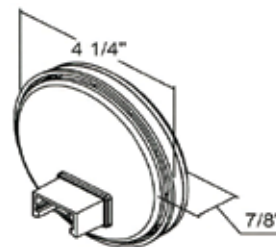

Part No.	Size	LED's	Lens Color	Connection	Mounting	Amp	Std. Qty.	Wt. (lbs.)	Cat.
NEW 5624156	4"	7	Red	PL-3 Connection	Grommet	.150	10	0.23	562 (N)
5624050	4"	Replacement Black Grommet					10	0.15	562 (N)

4" Round Stop/Turn/Tail Light with 10 LEDs



5624110
Plug and grommet included



5624150
Light only (sold in qty of 10)



5624151
Light only (sold in qty of 10)



5624050
(sold in qty of 10)

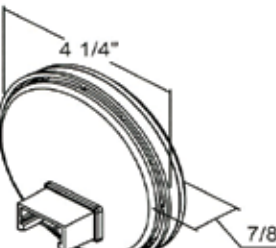

Part No.	Size	LED's	Lens Color	Connection	Mounting	Amp	Std. Qty.	Wt. (lbs.)	Cat.
NEW 5624110	4"	10	Red	PL-3 Connection	Grommet (Included)	.113	1	0.70	562 (N)
5624150	4"	10	Red	PL-3 Connection	Grommet	.113	10	0.36	562 (N)
5624151	4"	10	Red	AMP-Style Connection	Grommet	.105	10	0.34	562 (N)
5624050	4"	Replacement Black Grommet					10	0.15	562 (N)

4" Round Stop/Turn/Tail/Backup with 12 LEDs



2 LIGHTS IN ONE!



5624130
(sold in qty of 10)



5624050
(sold in qty of 10)

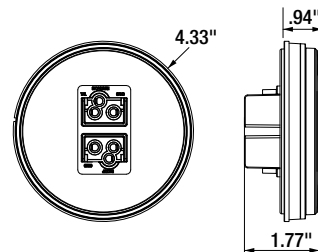

Part No.	Size	LED's	Lens Color	Connection	Mounting	Amp	Std. Qty.	Wt. (lbs.)	Cat.
NEW 5624130	4"	12	Red	PL-3 & PL-2 Connection	Grommet	.8	10	0.23	562 (N)
5624050	4"	Replacement Black Grommet					10	0.15	562 (N)

For plugs refer to **pg. C61**

4" Round & 6" Oval Stop, Turn & Tail Lights

4" Round Stop/Turn/Tail Light with 18 LEDs



5624118
Plug and grommet included



5624119
Light only (sold in qty of 10)



5624050
(sold in qty of 10)

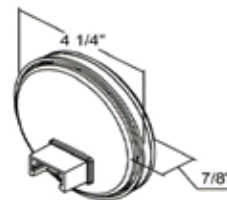

Part No.	Size	LED's	Lens Color	Connection	Mounting	Amp	Std. Qty.	Wt. (lbs.)	Cat.
5624118	4"	18	Red	PL-3 Connection	Grommet (Included)	.208	1	0.80	562 (N)
5624119	4"	18	Red	PL-3 Connection	Grommet	.208	10	0.40	562 (N)
5624050	4"	Replacement Black Grommet for use with 5624119, 5624118					10	0.15	562 (N)

4" Round Incandescent Stop/Turn/Tail Light



5654100
(sold in qty of 10)



5624050
(sold in qty of 10)

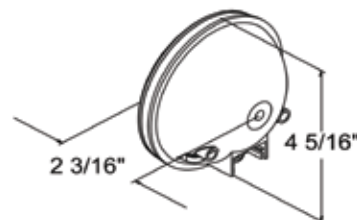

Part No.	Size	Lens Color	Connection	Mounting	Amp	Std. Qty.	Wt. (lbs.)	Cat.	
5654100	4"	Red	PL-3 Connection	PL-3	2.1/0.49	10	0.23	562 (N)	
5624050	4"	Replacement Black Grommet					10	0.15	562 (N)

6" Oval Stop/Turn/Tail Light with 1 LED



5626101
(sold in qty of 10)



5626050
(sold in qty of 10)

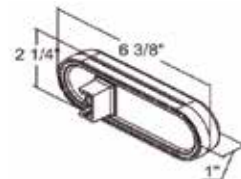

Part No.	Size	LED's	Lens Color	Connection	Mounting	Amp	Std. Qty.	Wt. (lbs.)	Cat.
NEW 5626101	6"	1	Red	PL-3 Connection	Grommet	.150	10	0.23	562 (N)
5626050	6"	Open Back, Flush Mount Grommet					10	0.18	562 (N)

6" Oval Stop/Turn/Tail Light with 6 LEDs



5626156
(sold in qty of 10)



5626050
(sold in qty of 10)

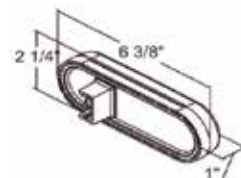

Part No.	Size	LED's	Lens Color	Connection	Mounting	Amp	Std. Qty.	Wt. (lbs.)	Cat.
5626156	6"	6	Red	PL-3 Connection	Grommet	.150	10	0.23	562 (N)
5626050	6"	Open Back, Flush Mount Grommet					10	0.18	562 (N)

For plugs refer to **pg. C61**



Products are Retail Packaged



6" Oval LED Stop, Turn, Tail & Backup Lights

6" Oval Stop/Turn/Tail Light with 10 LEDs

LIMITED LIFETIME WARRANTY 12 VOLTS



5626510
Plug and grommet included



5626050
(sold in qty of 10)



5626550
Light only
(sold in qty of 10)



5626551
Light only
(sold in qty of 10)



5626553
Light only
(sold in qty of 10)
Clear lens with red LEDs

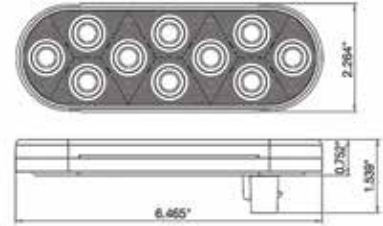

Part No.	Size	LED's	Lens Color	Connection	Mounting	Amp	Std. Qty.	Wt. (lbs.)	Cat.
5626510	6"	10	Red	PL-3 Connection	Grommet (Included)	.129	1	0.5	562 (N)
5626550	6"	10	Red	PL-3 Connection	Grommet	.129	10	0.36	562 (N)
5626551	6"	10	Red	AMP-Style Connection	Grommet	.112	10	0.29	562 (N)
5626553	6"	10	Clear	PL-3 Connection	Grommet	.129	10	0.36	562 (N)
5626050	6"	Open Back, Flush Mount Grommet					10	0.18	562 (N)

6" Hardwired Surface Mount Oval Stop/Turn/Tail Light Kit with 10 LEDs

LIMITED LIFETIME WARRANTY 12 VOLTS

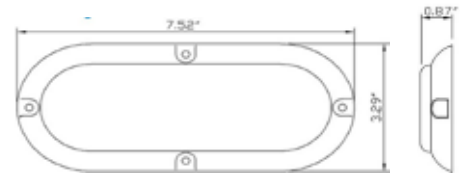

Part No.	Size	LED's	Lens Color	Connection	Mounting	Amp	Std. Qty.	Wt. (lbs.)	Cat.
5626552	6"	10	Red	Hard Wired with Stripped Leads & Ring Terminal	Surface	.106	1	0.34	562 (N)

6" Oval Stop/Turn/Tail/Backup Light with 14 LEDs

LIMITED LIFETIME WARRANTY 12 VOLTS IP 67

2 LIGHTS IN ONE!



5626130
(sold in qty of 10)



5626050
(sold in qty of 10)

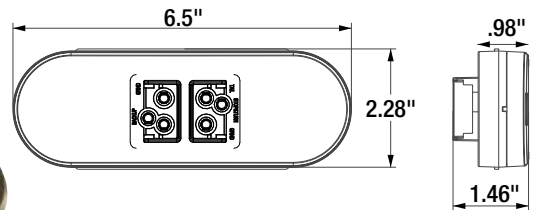

Part No.	Size	LED's	Lens Color	Connection	Mounting	Amp	Std. Qty.	Wt. (lbs.)	Cat.
NEW 5626130	6"	14	Red	PL-3 & PL-2 Connection	Surface	.8	10	0.3	562 (N)
5626050	6"	Open Back, Flush Mount Grommet					10	0.18	562 (N)

For plugs refer to **pg. C61**

6" Oval Stop/Turn/Tail Light with 20 LEDs



5626050
Plug and grommet included



5626521
Light only (sold in qty of 10)



5626050
(sold in qty of 10)

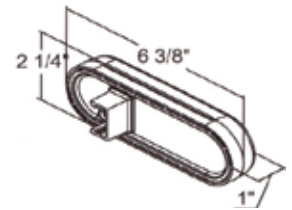

Part No.	Size	LED's	Lens Color	Connection	Mounting	Amp	Std. Qty.	Wt. (lbs.)	Cat.
5626520	6"	20	Red	PL-3 Connection	Grommet (Included)	0.162	1	0.83	562 (N)
5626521	6"	20	Red	PL-3 Connection	Grommet	.162	10	0.31	562 (N)
5626050	6"	Open Back, Flush Mount Grommet					10	0.18	562 (N)

6" Oval Incandescent Stop/Turn/Tail



5656100
Light only (sold in qty of 10)



5626050
(sold in qty of 10)

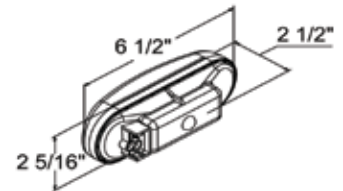

Part No.	Size	Lens Color	Connection	Mounting	Amp	Std. Qty.	Wt. (lbs.)	Cat.	
5656100	6"	Red	PL-3 Connection	Grommet	2.1/0.59	10	0.29	562 (N)	
5626050	6"	Open Back, Flush Mount Grommet					10	0.18	562 (N)

5.33" Rectangular Stop/Turn/Tail Kit with 15 LEDs



5625115
Plug and grommet included

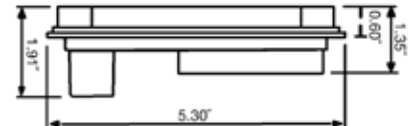

Part No.	Size	LED's	Lens Color	Connection	Mounting	Amp	Std. Qty.	Wt. (lbs.)	Cat.
5625115	5.33"	15	Red	PL-3 Connection	Grommet (Included)	.188	1	0.65	562 (N)

5.75" Box Style Stop/Turn/Tail and Back-Up with Reflex



- 5626738 Includes License Plate Light
- Includes Ground Wire



5626734



5626738
Includes built-in license plate light



5626700

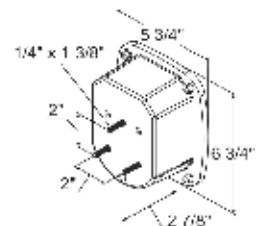

Part No.	Size	LED's	Lens Color	Connection	Mounting	Amp	Std. Qty.	Wt. (lbs.)	Cat.
5626734	5.75"	34	Red	Hard Wired with Stripped Leads, PS	Stud	.091	1	1.24	562 (N)
5626738	5.75"	38	Red	Hard Wired with Stripped Leads, DS	Stud	.091	1	1.24	562 (N)
5626700	5.75"	License Plate Bracket						0.12	562 (N)

For plugs refer to **pg. C61**



Products are Retail Packaged



5" Box-Style Stop, Turn, Tail Lights

5" Box-Style LED Stop/Turn/Tail Light (For Trailers Under 80" Wide)



- Grounds through mounting stud
- Red polycarbonate colored lens and built-in reflector lens
- 5625117 includes license light



5625111



5625117



5625111
Back and side shown



5625117
Shown with built-in license plate light

Part No.	Size	LED's	Lens Color	Connection	Mounting	Amp	Std. Qty.	Wt. (lbs.)	Cat.
5625111	5"	11	Red	Push-in Connections	Stud	.1	1	0.66	562 (N)
5625117	5"	17	Red	Push-in Connections	Stud	.1	1	0.70	562 (N)

5" Box-Style Stop/Turn/Tail with License Light (For Trailers Under 80" Wide) (Incandescent)



- Grounds through mounting stud
- Includes Reflector
- 5655001 includes license light



5655001
Shown with built-in license plate light



5655000

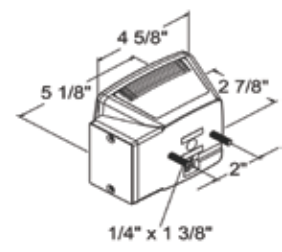

Part No.	Size	Lens Color	Connection	Mounting	Amp	Std. Qty.	Wt. (lbs.)	Cat.
5655000	5"	Red	Push-in Connections	Stud	2.1	10	0.52	562 (N)
5655001	5"	Red	Push-in Connections	Stud	2.1	10	0.47	562 (N)

5" Box-Style Stop/Turn/Tail with License Light (For Trailers Over 80" Wide) (Incandescent)



- Grounds through mounting stud
- Includes Reflector
- 5655101 includes license light



5655101
Shown with built-in license plate light



5655100

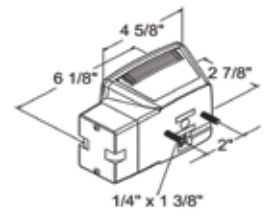

Part No.	Size	Lens Color	Connection	Mounting	Amp	Std. Qty.	Wt. (lbs.)	Cat.
5655100	5"	Red	Push-in Connections	Stud	2.1	10	0.50	562 (N)
5655101	5"	Red	Push-in Connections	Stud	2.1	10	0.52	562 (N)

For plugs refer to pg. C61

4" Round Turn and Park Light with 1 LED

LIMITED LIFETIME WARRANTY 12 VOLTS

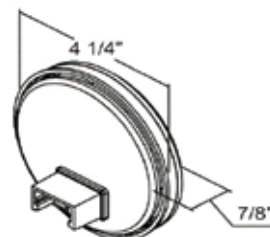

Part No.	Size	LED's	Lens Color	Connection	Mounting	Amp	Std. Qty.	Wt. (lbs.)	Cat.
NEW 5624201	4"	1	Amber	PL-3 Connection	Grommet	.15	10	0.70	562 (N)
5624050	4"	Black Grommet for use with 5624201					10	0.15	562 (N)

4" Round Turn Signal Light with 10 LEDs

LIMITED LIFETIME WARRANTY 12 VOLTS

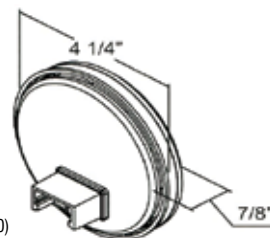

Part No.	Size	LED's	Lens Color	Connection	Mounting	Amp	Std. Qty.	Wt. (lbs.)	Cat.
NEW 5624210	4"	10	Amber	PL-3 Connection	Grommet (Included)	.221	1	0.70	562 (N)
5624251	4"	10	Amber	AMP-Style Connection	Grommet	.221	10	0.70	562 (N)
5624050	4"	Black Grommet for use with 5624251					10	0.15	562 (N)

6" Oval Turn and Park Signal Light with 1 LED

LIMITED LIFETIME WARRANTY 12 VOLTS

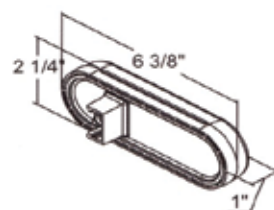
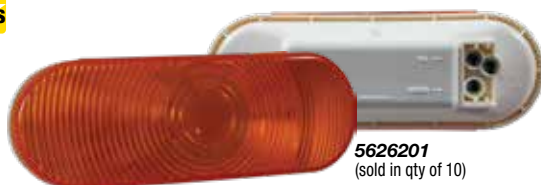

Part No.	Size	LED's	Lens Color	Connection	Mounting	Amp	Std. Qty.	Wt. (lbs.)	Cat.
NEW 5626201	6"	1	Amber	PL-3 Connection	Grommet	.15	10	0.71	562 (N)
5626050	6"	Open Back, Flush Mount Grommet						0.18	562 (N)

6" Oval Turn Signal Light with 10 LEDs

LIMITED LIFETIME WARRANTY 12 VOLTS

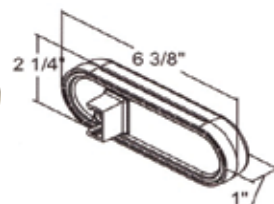

Part No.	Size	LED's	Lens Color	Connection	Mounting	Amp	Std. Qty.	Wt. (lbs.)	Cat.
5626210	6"	10	Amber	PL-3 Connection	Grommet (Included)	.224	1	0.71	562 (N)
5626211	6"	10	Clear	PL-3 Connection	Grommet	.224	10	0.31	562 (N)
5626050	6"	Open Back, Flush Mount Grommet						0.18	562 (N)

For plugs refer to pg. C61



Products are Retail Packaged



DOT LED Turn Signal and Backup Lights

LIGHTS - DOT

6" Midship Turn Signal and Side Marker with Reflex and 9 LEDs

LIMITED LIFETIME WARRANTY 12 VOLTS



5626209
Plug and grommet included



5626208
Light only
(sold in qty of 10)



5626050
(sold in qty of 10)

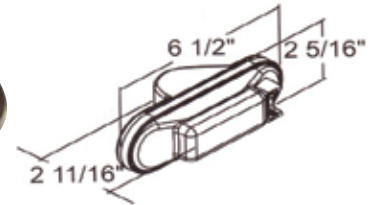

Part No.	Size	LED's	Lens Color	Connection	Mounting	Amp	Std. Qty.	Wt. (lbs.)	Cat.
5626209	6"	9	Amber	PL-3 Connection	Grommet (Included)	.114	1	0.30	562 (N)
5626208	6"	9	Amber	PL-3 Connection	Grommet	.114	10	0.30	562 (N)
5626050	6"	Open Back, Flush Mount Grommet						0.18	562 (N)

5.33" Rectangular Turn Signal Light Kit with 15 LEDs

LIMITED LIFETIME WARRANTY 12 VOLTS



5625215
Plug and grommet included

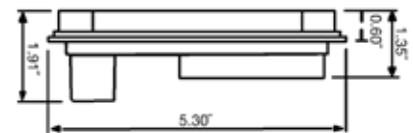

Part No.	Size	LED's	Lens Color	Connection	Mounting	Amp	Std. Qty.	Wt. (lbs.)	Cat.
5625215	5.33"	15	Amber	PL-3 Connection	Grommet	.245	1	0.71	562 (N)

4" Round Back-Up Light with 1 LED

LIMITED LIFETIME WARRANTY 12 VOLTS



5624301
(sold in qty of 10)



5624050
(sold in qty of 10)

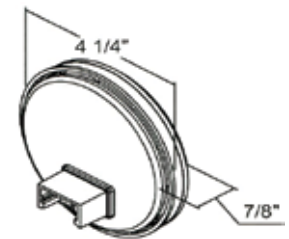

Part No.	Size	LED's	Lens Color	Connection	Mounting	Amp	Std. Qty.	Wt. (lbs.)	Cat.
5624301	4"	1	Clear	PL-2 Connection	Grommet	.150	10	0.23	562 (N)
5624050	4"	Flush Mount Grommet					10	0.15	562 (N)

4" Round Back-Up Light with 7 LEDs

LIMITED LIFETIME WARRANTY 12 VOLTS



5624356
(sold in qty of 10)



5624050
(sold in qty of 10)

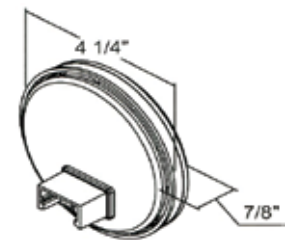

Part No.	Size	LED's	Lens Color	Connection	Mounting	Amp	Std. Qty.	Wt. (lbs.)	Cat.
5624356	4"	7	Clear	STD PL-2 Connection	Grommet	.150	10	0.23	562 (N)
5624050	4"	Flush Mount Grommet					10	0.15	562 (N)

For plugs refer to **pg. C61**

4" Round Backup Light Kit with 10 LEDs



5624310
Plug and grommet included



5624350
Light only (sold in qty of 10)



5624050
(sold in qty of 10)

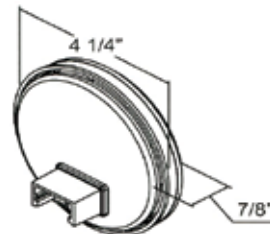

Part No.	Size	LED's	Lens Color	Connection	Mounting	Amp	Std. Qty.	Wt. (lbs.)	Cat.
5624310	4"	10	Clear	STD PL-2 Connection	Grommet (Included)	.213	1	0.70	562 (N)
5624350	4"	10	Clear	STD PL-2 Connection	Grommet	.213	10	0.36	562 (N)
5624050	4"	Flush Mount Grommet						0.15	562 (N)

4" Round Backup Light Kit with 24 LEDs



5624324
Plug and grommet included



5624325
Light only (sold in qty of 10)



5624050
(sold in qty of 10)

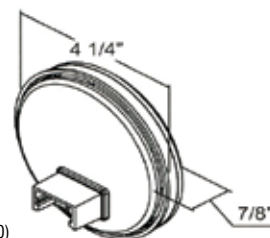

Part No.	Size	LED's	Lens Color	Connection	Mounting	Amp	Std. Qty.	Wt. (lbs.)	Cat.
5624324	4"	24	Clear	STD PL-2 Connection	Grommet (Included)	.141	1	0.80	562 (N)
5624325	4"	24	Clear	STD PL-2 Connection	Grommet	.141	10	0.42	562 (N)
5624050	4"	Flush Mount Grommet					10	0.15	562 (N)

4" Round Incandescent Backup Light



5654300
(sold in qty of 10)



5624050
(sold in qty of 10)

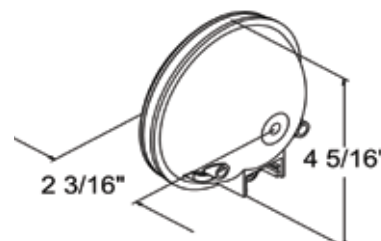

Part No.	Size	Lens Color	Connection	Mounting	Amp	Std. Qty.	Wt. (lbs.)	Cat.
5654300	4"	Clear	STD PL-2 Connection	Grommet	2.1	10	0.23	562 (N)
5624050	4"	Flush Mount Grommet					0.15	562 (N)

6" Oval Backup Light with 1 LED



5626301
(sold in qty of 10)



5626050
(sold in qty of 10)

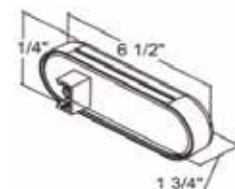

Part No.	Size	LED's	Lens Color	Connection	Mounting	Amp	Std. Qty.	Wt. (lbs.)	Cat.
5626301	6"	1	Clear	PL-2 Connection	Grommet	.15	10	0.23	562 (N)
5626050	6"	Open Back, Flush Mount Grommet					10	0.18	562 (N)

For plugs refer to **pg. C61**



Products are Retail Packaged



DOT LED Backup Lights

6" Oval Backup Light with 6 LEDs



5626356
(sold in qty of 10)



5626050
(sold in qty of 10)

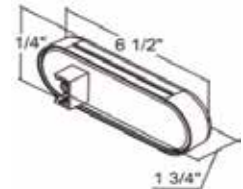

Part No.	Size	LED's	Lens Color	Connection	Mounting	Amp	Std. Qty.	Wt. (lbs.)	Cat.
5626356	6"	6	Clear	STD PL-2 Connection	Grommet	.150	10	0.23	562 (N)
5626050	6"	Open Back, Flush Mount Grommet					10	0.18	562 (N)

6" Oval Backup Light with 10 LEDs



5626310
Plug and grommet included



5626311
Light only (sold in qty of 10)



5626050
(sold in qty of 10)

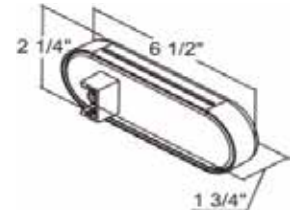

Part No.	Size	LED's	Lens Color	Connection	Mounting	Amp	Std. Qty.	Wt. (lbs.)	Cat.
5626310	6"	10	Clear	STD PL-2 Connection	Grommet (Included)	.218	1	0.70	562 (N)
5626311	6"	10	Clear	STD PL-2 Connection	Grommet	.138	10	0.38	562 (N)
5626050	6"	Open Back, Flush Mount Grommet					10	0.18	562 (N)

6" Oval Backup Light with 24 LEDs



5626324
Plug and grommet included



5626325
Light only (sold in qty of 10)



5626050
(sold in qty of 10)

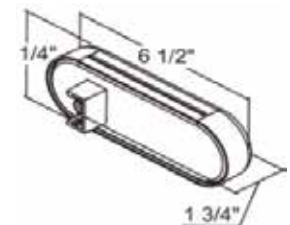

Part No.	Size	LED's	Lens Color	Connection	Mounting	Amp	Std. Qty.	Wt. (lbs.)	Cat.
5626324	6"	24	Clear	STD PL-2 Connection	Grommet (Included)	.138	1	0.86	562 (N)
5626325	6"	24	Clear	STD PL-2 Connection	Grommet	.218	10	0.43	562 (N)
5626050	6"	Open Back, Flush Mount Grommet					10	0.18	562 (N)

6" Oval Incandescent Back-Up Light



5656300
(sold in qty of 10)



5626050
(sold in qty of 10)

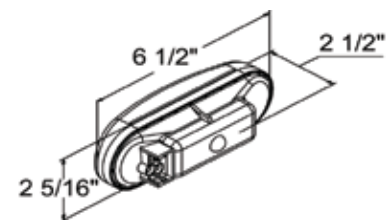

Part No.	Size	Lens Color	Connection	Mounting	Amp	Std. Qty.	Wt. (lbs.)	Cat.	
5656300	6"	Clear	STD PL-2 Connection	Grommet	2.1	10	0.29	562 (N)	
5626050	6"	Flush Mount Grommet						0.18	562 (N)

5.3" Rectangular Backup Light Kit with 32 LEDs



5625332
Plug and grommet included

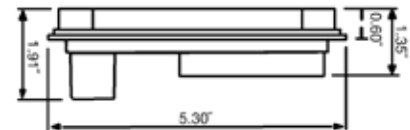

Part No.	Size	LED's	Lens Color	Connection	Mounting	Amp	Std. Qty.	Wt. (lbs.)	Cat.
5625332	5.33"	32	Clear	STD PL-2 Connection	Grommet	.301	1	0.55	562 (N)

For plugs refer to **pg. C61**

1.5" Round License/Utility with 4 LEDs

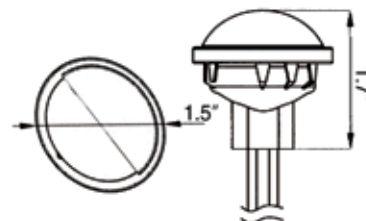

Part No.	Size	LED's	Lens Color	Connection	Mounting	Amp	Std. Qty.	Wt. (lbs.)	Cat.
5621534	1.5"	4	Clear	Hard Wired with Stripped Leads	Snap In	.030	1	0.10	562 (N)

Two lights needed to meet DOT requirements

1.5" Round Incandescent License/Utility Light



- Self grounding

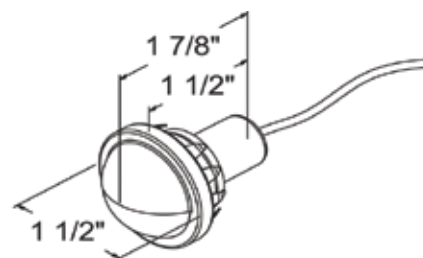

Part No.	Size	Lens Color	Connection	Mounting	Amp	Std. Qty.	Wt. (lbs.)	Cat.
5651530	1.5"	Clear	Hard Wired with Stripped Leads	Snap-in	0.59	10	0.07	889 (N)

2" License/Utility Light with 2 LEDs Series



5622032/5622132

5622130

5622133

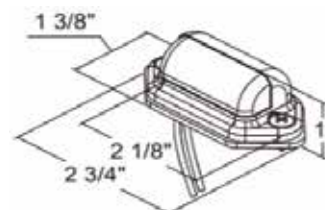

Part No.	Size	LED's	Housing Color	Connection	Mounting	Amp	Std. Qty.	Wt. (lbs.)	Cat.
5622032*	2"	2	Chrome	Hard Wired with Stripped Leads	Surface	.047	1	0.07	562 (N)
5622132	2"	2	Chrome	Hard Wired with Stripped Leads	Surface	.047	10	0.07	562 (N)
5622130	2"	2	Black	Hard Wired with Stripped Leads	Surface	.047	10	0.07	562 (N)
5622133	2"	2	Chrome	Hard Wired with .180 Male Bullets	Surface	.047	10	0.08	562 (N)

Two lights needed to meet DOT requirements

2" Surface Mount License Plate Light Kit

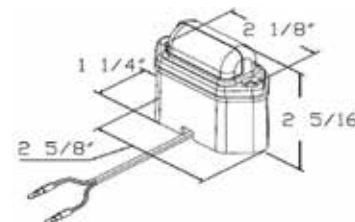

Part No.	Size	LED's	Housing Color	Connection	Mounting	Amp	Std. Qty.	Wt. (lbs.)	Cat.
5622134	2"	2	Clear	Hard Wired with .180 Male Bullets	Surface	.047	10	0.13	562 (N)

One light needed to meet DOT requirements

For plugs refer to pg. C61



Products are Retail Packaged



License / Utility Plate Lights

2" Rectangular Incandescent License/Utility Light

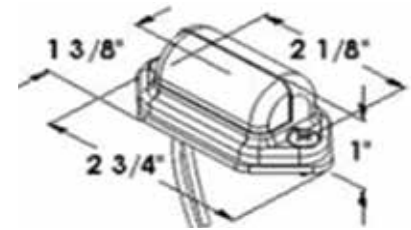

Part No.	Size	Lens Color	Connection	Mounting	Amp	Std. Qty.	Wt. (lbs.)	Cat.
5652030	2"	Clear	Hard Wired with Stripped Leads	Surface	0.33	10	0.07	889 (N)

2-5/8" Incandescent License/Utility Light



- Self Grounding

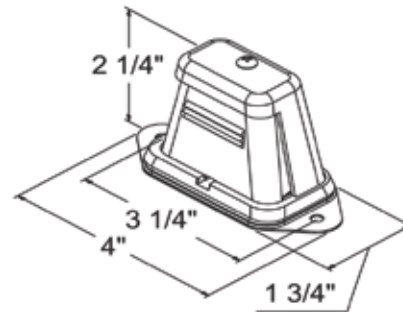

Part No.	Size	Lens Color	Connection	Mounting	Amp	Std. Qty.	Wt. (lbs.)	Cat.
5652630	2.625"	Clear	Hard Wired with Stripped Lead	Surface	0.33	10	0.16	889 (N)

2-3/8" Incandescent License/Utility Light



5653375



5653376
Optional bracket

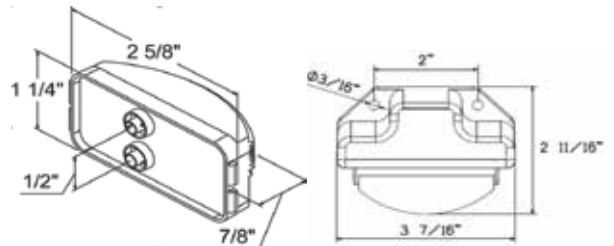

Part No.	Size	Lens Color	Connection	Mounting	Amp	Std. Qty.	Wt. (lbs.)	Cat.	
5653375	2.375"	Clear	PL-10 Connection	Bracket	0.33	10	0.04	889 (N)	
5653376	Bracket for 2.375" License Light, for use with 5653375						10	0.11	889 (N)

2.75" License Plate Light with 2 LEDs

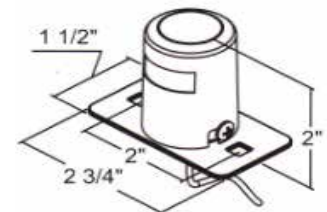

Part No.	Size	LED's	Housing Color	Connection	Mounting	Amp	Std. Qty.	Wt. (lbs.)	Cat.
5622754	2.75"	2	Clear	Hard Wired with Stripped Leads	Surface	.086	10	0.17	562 (N)

Two lights needed to meet DOT requirements

For plugs refer to **pg. C61**

DOT Turn Signal Equalizer Plugs

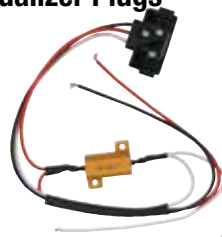

- 25 Watt rating



5621010



5621012

Part No.	Description	Std. Qty.	Wt. (lbs.)	Cat.
 5621010	LED Turn Signal Equalizer with Right Angle Male PL-3 Plug and Stripped Leads	1	0.12	562 (N)
 5621012	LED Turn Signal Equalizer with Right Angle Male PL-3 Plug and Straight Female PL-3 Plug	1	0.15	562 (N)

DOT Light Plugs



5620250



5620251



5620350



5620351



5620352



5620354



5620355

Part No.	Description	Std. Qty.	Wt. (lbs.)	Cat.
5620250	2-Pin In-Line Male PL-10 Plug with Stripped Power Wire and #10 Ring on Ground	1	0.03	562 (N)
NEW 5620251	2-Pin Right Angle Male Plug with Stripped Power Wire and #10 Ring on Ground		0.03	562 (N)
5620350	3-Pin Right Angle Male PL-3 Plug with Stripped Leads and #10 Ring on Ground	1	0.03	562 (N)
5620351	3-Wire AMP-Style Plug, 3-Pin Straight Female PL-3 Plug	1	0.07	562 (N)
5620352	3-Wire AMP-Style Plug, with Stripped Leads and #10 Ring on Ground	1	0.03	562 (N)
5620354	3-Wire AMP-Style Plug, with 3-Pin Right Angle Male PL-3 Plug	1	0.06	562 (N)
5620355	3-Wire, 3-Pin Straight Male PL-3 Plug with Stripped Leads and #10 Ring on Ground	1	0.05	562 (N)

DOT Reflectors



5623316



5623317



5623000



5623001



5623520



5623521

Part No.	Description	Std. Qty.	Wt. (lbs.)	Cat.
5623316	3-3/16" Round, Bolt-on, Red	10	0.50	889 (N)
5623317	3-3/16" Round, Bolt-on, Amber	10	0.50	889 (N)
5623000	3" Round, Stick-on, Red 100 per Role	1 Roll	0.55	889 (N)
5623001	3" Round, Stick-on, Amber 100 per Role	1 Roll	0.55	889 (N)
5623520	3-1/2" Rectangular, Stick-on, Red 500 per Role	1 Roll	2.20	889 (N)
5623521	3-1/2" Rectangular, Stick-on, Amber 500 per Role	1 Roll	2.20	889 (N)

DOT Conspicuity Tape

- DOT approved
- ASTM D4956 - 93B Type V
- LS300C
- FP92
- NHTSA 49 CFT, Part 571, DOT-C2
- 5-Year Rating

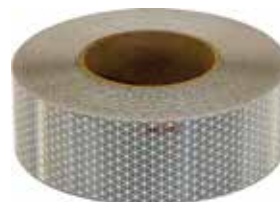
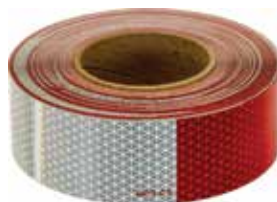

Part No.	Description	Std. Qty.	Wt. (lbs.)	Cat.
CT150RW	DOT Conspicuity Tape, 150' Roll, 11" Red, 7" White	1	1.5	889 (N)
CT150W12	150' Roll, White, 12" Lengths	1	1.5	889 (N)



Products are Retail Packaged



Spreader Light Bar Kits

44" Light Bar Kits



- Fixed & hinged mounting options included



8891144



8891145

Part No.	Description	Cat.
8891144 (Round)	(1) 304 Stainless Steel Light Box, Dimension: 44" L x 8" H x 3" D (2) 4" Round STT Lights, 10 Red LEDs (2) 4" Round Strobe Lights, 24 Amber LEDs (3) 2.5" Round Marker Lights, 4 Red LEDs (1) Wire Harness (2) LED Load Equalizers	889 (N)
8891145 (Oval)	(1) 304 Stainless Steel Light Box, Dimension: 44" L x 8" H x 3" D (2) 6" Oval STT Lights, 10 Red LEDs (2) 6" Oval Strobe Lights, 24 Amber LEDs (3) 2.5" Round Marker Lights, 4 Red LEDs (1) Wire Harness (2) LED Load Equalizers	889 (N)

66" Light Bar Kits



- Fixed & hinged mounting options included



8891150



8891168



8891166



8891169



8891167

Part No.	Description	Cat.
8891150 (Oval)	(1) 304 Stainless Steel Light Box, Dimension: 66" L x 4" H x 3" D (2) 6.5" Oval STT Lights, 10 Red LEDs (2) 6.5" Oval Strobe Lights, 24 Amber LEDs (3) .75" Round Marker Lights, 3 Red LEDs (1) Wire Harness (2) LED Load Equalizers/Turn Signals	889 (N)
8891166 (Round)	(1) 304 Stainless Steel Light Box, Dimension: 66" L x 8" H x 3" D (2) 4" Round STT Lights, 10 Red LEDs (2) 4" Round Back-Up Lights, 10 Clear LEDs (2) 4" Round Strobe Lights, 24 Amber LEDs (3) 2.5" Round Marker Lights, 4 Red LEDs (1) Wire Harness (2) LED Load Equalizers	889 (N)
8891167 (Round)	(1) 304 Stainless Steel Light Box, Dimension: 66" L x 8" H x 3" D (4) 4" Round STT Lights, 10 Red LEDs (2) 4" Round Strobe Lights, 24 Amber LEDs (3) 2.5" Round Marker Lights, 4 Red LEDs (1) Wire Harness (2) LED Load Equalizers	889 (N)
8891168 (Oval)	(1) 304 Stainless Steel Light Box, Dimension: 66" L x 8" H x 3" D (2) 6" Oval STT Lights, 10 Red LEDs (2) 6" Oval Back-Up Lights, 10 Clear LEDs (2) 6" Oval Strobe Lights, 24 Amber LEDs (3) 2.5" Round Marker Lights, 4 Red LEDs (1) Wire Harness (2) LED Load Equalizers	889 (N)
8891169 (Oval)	(1) 304 Stainless Steel Light Box, Dimension: 66" L x 8" H x 3" D (4) 6" Oval STT Lights, 10 Red LEDs (2) 6" Oval Strobe Lights, 24 Amber LEDs (3) 2.5" Round Marker Lights, 4 Red LEDs (1) Wire Harness (2) LED Load Equalizers	889 (N)

77" Light Bar Kits



- Fixed & hinged mounting options included



8891177



8891178

Part No.	Description	Cat.
8891177 (Oval)	(1) 304 Stainless Steel Light Box, Dimension: 77" L x 4" H x 3" D (2) 6.5" Oval Strobe Lights, 24 Amber LEDs (2) 6.5" Oval Back-Up Lights, 10 Clear LEDs (2) 6.5" Oval STT, 10 Red LEDs (3) .75" Round Marker Lights, 3 Red LEDs (1) Wire Harness (2) LED Load Equalizers	889 (N)
8891178 (Oval)	(1) 304 Stainless Steel Light Box, Dimension: 77" L x 4" H x 3" D (4) 6" Oval STT Lights, 10 Red LEDs (2) 6" Oval Strobe Lights, 24 Amber LEDs (3) .75" Round Marker Lights, 3 Red LEDs (1) Wire Harness (2) LED Load Equalizers/Turn Signal	889 (N)

44" Stainless Steel Light Bar for Round Lights

- (4) 4" and (3) 2-1/2" round cutouts
- Fixed & hinged mounting options
- Stainless steel DOT light bars only
- Mounts included
- Lights not included



Part No.	Description	Cat.
LB8443SST	7 Hole Round, 8" x 3" x 44"	903-1 (N)

44" Stainless Steel Light Bar for Oval Lights

- (4) 6" Oval and (3) 2-1/2" round cutouts
- Fixed & hinged mounting options
- Stainless steel DOT light bars only
- Mounts included
- Lights not included

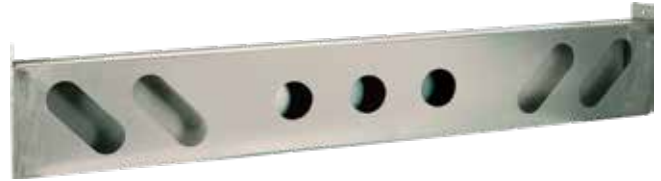

Part No.	Description	Cat.
LB8445SST	7 Hole (4 Oval, 3 Round), 8" x 3" x 44"	903-1 (N)

66" Stainless Steel Light Bar for Round Lights

- (6) 4" and (3) 2-1/2" round cutouts
- Fixed & hinged mounting options
- Stainless steel DOT light bars only
- Mounts included
- Lights not included



Part No.	Description	Cat.
LB8663SST	9 Hole Round, 8" x 3" x 66"	903-1 (N)

66" Stainless Steel Light Bar for Oval Lights

- (6) 6" Oval and (3) 2-1/2" round cutouts
- Fixed & hinged mounting options
- Stainless steel DOT light bars only
- Mounts included
- Lights not included



Part No.	Description	Cat.
LB8665SST	9 Hole (6 Oval, 3 Round), 8" x 3" x 66"	903-1 (N)

66" Stainless Steel Light Bar for Large Oval Lights

- (4) 6" Oval and (3) 3/4" ID marker light cutouts
- Mounting hardware included
- Lights not included



Part No.	Description	Cat.
LB4663SST	7 Hole (4 Oval, 3 Round) 4" x 3" x 66"	903-1 (N)

77" Stainless Steel Light Bar for Oval Lights

- (6) 6" Oval cutouts, (3) 3/4" ID marker light cutouts
- Mounting hardware included
- Lights not included



Part No.	Description	Cat.
LB4773SST	9 Hole (6 Oval, 3 Round) 4" x 3" x 77"	903-1 (N)

Wiring Harness

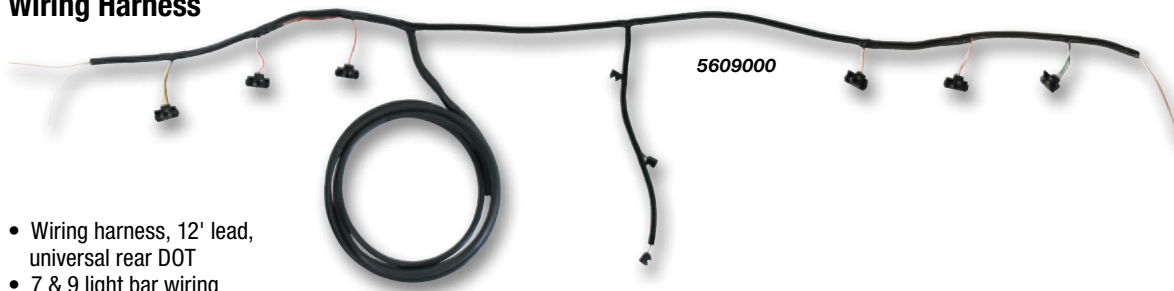

- Wiring harness, 12' lead, universal rear DOT
- 7 & 9 light bar wiring

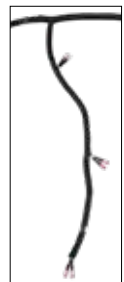

5609001- Male Bullet Connector Plugs

Part No.	Description	Cat.
5609000	12' Wiring Harness	560 (N)
5609001	12' Wiring Harness with 3 Female Bullet Connectors for use with 3/4" ID Marker Lights with Male Bullet Connectors on LB4663SST and LB4773SST	560 (N)



DOT Light Boxes

Single Oval Light Boxes



LB383



LB383SL



LB383SST



LB383ALDT



LB383ALSM



LB383P



LB384



LB384ST

Part No.	Description	Cat.
LB383	Single Oval, Black Powder Coat Steel, (3" x 8" x 3")	520 (N)
LB383SL	Single Oval with Side Light, Black Powder Coat Steel, (3" x 8" x 3")	520 (N)
LB383SST	Single Oval, Stainless Steel, (3" x 8" x 3")	520 (N)
LB383ALDT	Single Oval, Diamond Tread Aluminum, (3" x 8" x 3")	520 (N)
LB383ALSM	Single Oval, Smooth Aluminum, (3" x 8" x 3")	520 (N)
LB383P	Single Oval, Black Polymer, (3" x 8" x 3")	520 (N)
LB384	Single Oval, Both Front and Back, Black Powder Coated Steel, (3" x 8" x 4")	520 (N)
LB384SST	Single Oval, Both Front and Back, Stainless Steel, (3" x 8" x 3")	520 (N)

Dual Oval Light Boxes



LB3163



LB3163SST



LB3163ALDT



LB3163SLALDT

Part No.	Description	Cat.
LB3163	Dual Oval Black Powder Coat Steel, (3" x 16" x 3")	520 (N)
LB3163SST	Dual Oval Stainless Steel, (3" x 16" x 3")	520 (N)
LB3163ALDT	Dual Oval Diamond Tread Aluminum, (3" x 16" x 3")	520 (N)
LB3163SLALDT	Dual Oval Side Light, Diamond Tread Aluminum, (3" x 16" x 3")	520 (N)

Triple Oval Light Boxes



Part No.	Description	Cat.
LB3253	Triple Oval, Black Powder Coat Steel, (3" x 25" x 3")	520 (N)
LB3253ALDT	Triple Oval Diamond Tread Aluminum, (3" x 25" x 3")	520 (N)
LB3253SST	Triple Oval Stainless Steel, (3" x 25" x 3")	520 (N)
LB8133	Triple Oval Vertical or Horiz, Steel, Gray Primer, (8" x 13" x 3")	520 (N)

Single Round Light Boxes

- Front opening dia. 4.50"
- Side light dia. 2.323"



LB663



LB663SL



LB663SST

Part No.	Description	Cat.
LB663	Single Round Black Powder Coat Steel, (6" x 6" x 3")	520 (N)
LB663SL	Single Round with 2" Side Light, Black Powder Coat Steel, (6" x 6" x 3")	520 (N)
LB663SST	Single Round Stainless Steel, (6" x 6" x 3")	520 (N)

DOT Light Boxes

Dual Round Light Boxes



Part No.	Description	Cat.
LB6123	Dual Round, Black Powder Coat Steel, (6" x 12" x 3")	520 (N)
LB6123SST	Dual Round, Stainless Steel, (6" x 12" x 3")	520 (N)
LB6123ALDT	Dual Round, Diamond Tread Aluminum, (6" x 12" x 3")	520 (N)

Triple Round Light Boxes



Part No.	Description	Cat.
LB6183	Triple Round, Black Powder Coat Steel, (6" x 18" x 3")	520 (N)
LB6183SST	Triple Round Stainless Steel	520 (N)
LB6183ALDT	Triple Round, Diamond Tread Aluminum	520 (N)

DOT Light Mounting Brackets



Part No.	Description	Cat.
LB1	Single Oval, Black, 8.25" x 4.0"	520 (N)
LB1SS	Single Oval, Stainless Steel, 8.25" x 4.0"	520 (N)
LB253	Triple Round, Black, 8.25" x 4.0" for 2.5" Lights	520 (N)

ELECTRICAL

Electrical accessories and parts for all of your equipment needs. From Switches, Solenoids, and Circuit Breakers, to Light Bar Kits, Safety Cameras, and more.

OBSERVATION SYSTEMS	D2
NEW & IMPROVED Observation Systems	D2
BOOSTER CABLES	D4
ROADSIDE ASSISTANCE EQUIPMENT	D4
ELECTRICAL SWITCHES	D5
CIRCUIT BREAKERS	D7
SOLENOIDS AND MOTORS	D7
METERS	D9
BATTERY ADAPTERS	D9
JUNCTION BOXES AND FUSE HOLDERS	D10



Observation Systems

Rear Observation System with Night Vision Camera

- 7" TFT-LCD Color monitor
- Auto reverse "on"
- Audio
- Adjustable mounts
- Heated night vision camera with audio
- Multiple camera capable
- Wireless remote
- 65' cable

2-YEAR
W 12-24
VOLTS IP
67



Part No.	Description	Cat.
NEW 8883000	Rear Observation System with Standard Camera	888 (N)

Rear Observation System with License Plate Night Vision Camera

- 7" TFT-LCD Color monitor
- Auto reverse "on"
- Audio
- Adjustable mounts
- License plate night vision camera
- Multiple camera capable
- Wireless remote
- 65' cable

2-YEAR
W 12-24
VOLTS IP
67



Part No.	Description	Cat.
NEW 8883010	Rear Observation System, License Plate Camera	888 (N)

Rear Observation System with Recessed Night Vision Camera

- 7" TFT-LCD Color monitor
- Auto reverse "on"
- Audio
- Adjustable mounts
- Recessed night vision camera
- Multiple camera capable
- Wireless remote
- 65' cable

2-YEAR
W 12-24
VOLTS IP
67



Part No.	Description	Cat.
NEW 8883020	Rear Observation System, Bullet Recessed Camera	888 (N)

Rearview Mirror Monitor Rear Observation System with Night Vision Camera

- 4.3 TFT-LCD Mirror Monitor replaces OEM mirror
- Illuminated touch screen buttons
- Compact, IP68 back-up camera with night vision

2-YEAR
W 12-24
VOLTS IP
67



Part No.	Description	Cat.
NEW 8883030	Rear Observation System, Universal OEM 4.3" Monitor	888 (N)

Quad Screen Rear Observation System with Night Vision Backup Camera

- 7" TFT-LCD Color quad screen monitor
- Heated night vision camera with audio
- Auto reverse "on"
- Shows up to 4 camera views on same screen
- Audio
- Adjustable mounts
- Wireless remote
- 65' cable

2-YEAR
W 12-24
VOLTS IP
67



Part No.	Description	Cat.
NEW 8883040	Rear Observation System, Quad Screen (1) Standard Camera	888 (N)
8883101	Additional Camera	888 (N)

Wireless Rear Observation System with Backup Camera

- 7" TFT-LCD Color wireless monitor
- Auto reverse "on"
- Audio
- Adjustable mounts
- Wireless night vision camera with audio
- Wireless remote
- 65' cable

2-YEAR
W 12-24
VOLTS IP
67



Part No.	Description	Cat.
NEW 8883200	Wireless Rear Observation System*	888 (N)

Color Camera with Heated Night Vision and Audio

2-YEAR W **12-24 VOLTS** **IP 67**



Part No.	Description	Cat.
8883101	Camera, Standard, IP67, Night Vision, Heated, Audio	888 (N)

License Plate Mount Camera

1-YEAR W **12-24 VOLTS** **IP 67**



Part No.	Description	Cat.
8883102	License Plate, waterproof, 4-Pin	888 (N)

Color Bullet Camera for Recessed Mounting with Night Vision

1-YEAR W **12-24 VOLTS** **IP 67**



Part No.	Description	Cat.
8883103	Camera, Recessed 1" Dia. Bullet, IP67, Night Vision	888 (N)

Surface Side Mount Camera, Color with Night Vision

1-YEAR W **12-24 VOLTS** **IP 67**



Part No.	Description	Cat.
8883104	Camera, Side, Universal, IP67, Night Vision	888 (N)

Surface Mount Cube Camera, Color with Night Vision

1-YEAR W **12-24 VOLTS** **IP 67**



Part No.	Description	Cat.
8883106	Cube Surface Mount, Camera, Waterproof, 4-Pin	888 (N)

Camera Cable for Rear Observation systems and Backup Cameras

1-YEAR W **12-24 VOLTS** **IP 67**



Part No.	Description	Cat.
8883116	Cable, 16'/5m	888 (N)
8883132	Cable, 32'/10m	888 (N)
8883165	Cable, 65'/20m	888 (N)
8883182	Cable, 82'/25m	888 (N)

Universal Camera Washing System



Camera not included

- Hi-pressure
- Works with camera, **8883101**
- Includes: 1-1/2 quart tank with mounting bracket, 9-1/2 ft fluid tube with pressure nozzle, Pump, in-cab controller, 32 ft power cord, mounting hardware.

Part No.	Description	Cat.
8882150	Universal Camera Washing System, 12-24 VDC	888 (N)

Dual Camera

1-YEAR W **12-24 VOLTS** **IP 67**



Part No.	Description	Cat.
8883108	Dual Camera, Waterproof, 4-pin	888 (N)

Standard Wireless Camera

1-YEAR W **12-24 VOLTS** **IP 67**



Part No.	Description	Cat.
8883211	Camera, Standard, IP67, Night Vision, Heated, Wireless	888 (N)

Sphere Surface Mount Camera with Night Vision



Part No.	Description	Cat.
8883105	Sphere Surface Mount, Waterproof, 4-Pin	888 (N)

Self-Grounding Backup Alarms

2-YEAR W **12-24 VOLTS** **SAE J994**



BA0972



BA102/BA107

- Low frequency tone
- Epoxy sealed from moisture, dust & vibration
- Self-grounding
- Full-color display box
- Meets OSHA, Bureau of Mines, GSA & all state regulations

Part No.	Description	Cat.
BA0972	97 dB, 4" L x 1-5/8" W x 2-5/8" T	888 (N)
BA102	102 dB, 4" L x 1-5/8" W x 2-5/8" T	888 (N)
BA107	107 dB, 4" L x 1-3/4" W x 3-1/16" T	888 (N)



Booster Cables and Roadside Assistance

Booster Cables with Quick Connect

- 22' Booster cable plus 6' battery side cable with quick connects
- 4 AWG insulated cable
- 600 Amp



Blue Quick Connector



Gray Quick Connector

Part No.	Description	Cat.
5601025	Cables with Gray Quick Connect, 28' Kit	560 (N)
5601026	Cables with Blue Quick Connect, 28' Kit	560 (N)
5601015	Gray Quick Connect Replacement Set	560 (N)
5601016	Blue Quick Connect Replacement Set	560 (N)
5601020	6' Battery Side Cable with Gray Quick Connect	560 (N)
5601021	6' Battery Side Cable with Blue Quick Connect	560 (N)

Heavy-Duty Towing Light Set

- Durable 30' cord with 4-pole spring plug easily activates turn signal, brakes and tail lights
- Visible for up to one mile
- Includes plastic storage case



Part No.	Description	Cat.
TL257M	Towing Lights, Plastic Storage Case	889 (N)

4" Round Rechargeable Magnetic Road Strobe/Flare

IP 67

- 1.25" thick x 4.25" diameter
- Rechargeable 110V AC
- USB and 12 VDC adapter included
- 9 flash patterns



8891016
Single road strobe/flare



8891018
Case of 6 road strobe/flare

Part No.	Size	LEDs	Color	Amp	Flash	Wt. (lbs.)	Cat.
8891016	4"	16	Amber	0.50	(1) LED Road Flare, (1) 12 volt and 110 volt charging connections	0.85	889 (N)
8891018 Pack of 6 with Charging Case	4"	16	Amber	0.50	Case includes (6) LED road flares, 12 volt and 110 volt charging connections. Storage doubles as a charging base	6.42	889 (N)

For Charge/Run Times Visit BuyersProducts.com

Pre-wired Switch Panels



6391001

- Single Switch Panel, Prewired and fused
- 10 Amp, On-Off
- 2" L x 1.625"W x 2.25"T
- Backlit



6391002

- Double Switch Panel
- 15 Amp, On-Off
- 3" L x 1.625"W x 2.25"T
- Backlit



6391003

- Triple Switch Panel, Prewired and fused
- 20 Amp, On-Off
- 3.875"L x 1.625"W x 2.25"T
- Backlit



6391004

- Quad Switch Panel (2)
- 10 Amp
- On-Off
- 4.75"L x 1.625"W x 2.25"T
- Backlit

Part No.	Description	Cat.
6391001	Switch Panel, Single, On-Off Illuminated	639 (N)
6391002	Switch Panel, Double, On-Off Illuminated	639 (N)
6391003	Switch Panel, Triple, On-Off Illuminated	639 (N)
6391004	Switch Panel, Quad, On-Off Illuminated	639 (N)
6391101	Replacement Rocker Switch, On/Off Red, 12VDC	639 (N)

8 Function Switch Panel



- Each push button is back lit and accommodates a custom legend (included)
- LED status indicator for each switch
- 15 amps/switch power module

See buyersproducts.com for more details.

Part No.	Description	Cat.
6391308	8 Function Panel Switch, Illuminated-On, Prewired	639 (N)

Pre-Wired Switch Panels



6391204



6391205



6391206, 6391207



6391208



6391209

Part No.	Description	Cat.
6391204	4 Switch Panel: (3) On/Off, (1) Momentary	639 (N)
6391205	5 Switch Panel: (3) Lights, (1) Flash Button, (1) On/Off	639 (N)
6391206	6 Switch Panel: (4) On/Off, (2) Momentary, with LED Indicators and Harnesses, used with Modular 49", 54", & 60" Lightbars	639 (N)
6391207	6 Switch Panel: (4) On/Off, (2) Momentary, with LED Indicators and Harnesses, used with 8894037 & 8894047 Directional Warning Lights	639 (N)
6391208	Switch Panel, 7 Function, Multi-Purpose, Programmable used with Modular 49", 54", & 60" Lightbars	639 (N)
6391209	Switch Panel, 8 Function, Multi-Purpose, Programmable, with Relays used with Modular 49", 54", & 60" Lightbars	639 (N)

Pre-wired Switch Boxes

- Pre-wired switch boxes fused with relay & circuit breaker
- Individually fused
- Backlit
- Multiple legends included



6391104



6391106

Part No.	Description	Cat.
6391104	4- Function Backlit Switch Box (3) 20 Amp, (1) 40 Amp	639 (N)
6391106	6- Function Backlit Switch Box (5) 20 Amp, (1) 40 Amp	639 (N)
6391101	Mini Rocker Switch, On-Off, Illuminated, Replacement	639 (N)



Switches

Mini Round Rocker Switches

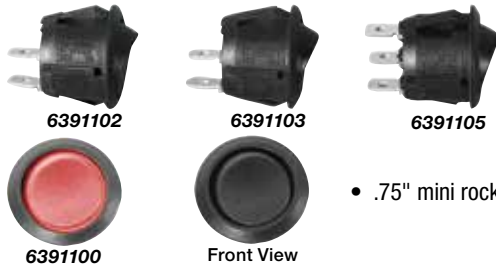

- .75" mini rocker switch

Part No.	Description	Cat.
6391100	On-Off, Illuminated	639 (N)
6391102	On-Off	639 (N)
6391103	On-Off-On	639 (N)
6391105	Momentary-On	639 (N)

Pre-wired Switch with Momentary Button



- On-off, flash pattern control
- 15' Pre-wired cable
- 10 Amp
- 2-1/2"L x 1-1/2"W x 1"H
- Commonly used with strobes on pages C25-C33

Part No.	Description	Cat.
6391215	Switch Panel, On-Off with Flash Pattern	639 (N)

Panel Mount Momentary Push Button Switch



- Weatherproof, dust proof, single pole, single throw
- Rubber cap & mounting nut assembly, two screw terminals with lock-washers
- Mounting stem 5/8"-32 Thd., 21/32" long
- Max 35 amps

Part No.	Description	Cat.
BSW90030	Switch, Momentary Push Button	639 (N)

50 AMP Rotary Switch



- Commonly used with tarp gear motors
- Heavy-duty 50 AMP rotary switch controls forward and reverse motion of a 12-volt motor. No relay required
- Momentary on/off/momentary on lever type actuator
- 4 screw terminals with silver laminated contacts
- M12 x 1.0 mounting threads
- Aluminum name plate included

Part No.	Description	Cat.
SW710	Switch, 50 AMP, Rotary, Momentary	639 (N)

12 Volt Momentary Switch



- Push for ON, Spring return for OFF
- Two brass terminals
- Two 5/8"-32 brass screws
- 2-5/16" long OD
- 5/8" diameter mounting hole, fits through 3/4" thick panel
- Moisture repellent insulator

Part No.	Description	Cat.
SW901	Switch, Momentary, 12V, (2) Terminals	639 (N)

Rocker Switch & Bracket



- Commonly used with tarp gear motors

shown with bracket installed must purchase separately

Part No.	Description	Cat.
3014187	12 Volt, Double Momentary Open/Close	639 (N)
3014188	Rocker Switch Bracket	639 (N)

LED Strobe Controller



- LED strobe flasher
- Includes 2-sided 3M mounting tape and 3 wire taps
- 12-24V
- 6 Amps
- Commonly used with strip lights on page C14

Part No.	Description	Cat.
5621002	Controller, Strobe, LED, 12VDC, 6 Amps	639 (N)

Heavy Duty Rotary On/Off Switch



- Single pole battery disconnect, two position (on & off)
- 12V DC, 20A continuous 125A intermittent +15 sec.on, min off
- Two 3/8" copper terminal studs
- Brass mounting stem
- 3/4"-16 Thd., 23/32" long, fits through 3/16" thick panel

Part No.	Description	Cat.
SW700	Switch with Face Plate	639 (N)

High-Low Beam Push-Button Switch



- Single pole, single throw switch with 5/16"-24 Thd.
- Stud terminals 29/32" mounting holes 1-3/4" on center
- Top of button extends 1" above faceplate

Part No.	Description	Cat.
BSW002	Switch, Tailgate, Heavy-Duty	600 (N)

12V Recessed Toggle Switch



- 12 VDC, 10 AMP switch with panel mount
- Two blade terminals
- Recessed pan protects switch from impacts & accidental activation
- 20 gauge zinc plated steel pan
- 2" diameter mounting hole

Part No.	Description	Cat.
SW911	Switch, Toggle, 12V (2) Blade Terminals and Recessed Panel Mount	639 (N)
SW9111	Switch, Toggle, 12V (2) Blade Terminals	639 (N)

Hi-Amp Circuit Breakers

- For cranes, dump hoists, liftgates, plows, spreaders, etc.
- Auto reset or a manual reset, push-to-trip
- 1/4-28 silver plated studs and stainless steel nuts with rubber boots
- Waterproof



Part No.	Amps	Action	Cat.
CB30PB	30	Manual Reset, Push-to-Trip	560 (N)
CB50	50	Auto Reset	560 (N)
CB50PB	50	Manual Reset, Push-to-Trip	560 (N)
CB60	60	Auto Reset	560 (N)
CB60PB	60	Manual Reset, Push-to-Trip	560 (N)
CB80PB	80	Manual Reset, Push-to-Trip	560 (N)
CB90PB	90	Manual Reset, Push-to-Trip	560 (N)
CB100	100	Auto Reset	560 (N)
CB100PB	100	Manual Reset, Push-to-Trip	560 (N)
CB120PB	120	Manual Reset, Push-to-Trip	560 (N)
CB150	150	Auto Reset	560 (N)
CB150PB	150	Manual Reset, Push-to-Trip	560 (N)
CB200PB	200	Manual Reset, Push-to-Trip	560 (N)
CB1		Terminal Adapter for Larger Eyelets	520 (N)

Hi-Amp Panel Mount Circuit Breakers

- For cranes, dump hoists, liftgates, plows, spreaders, etc.
- Auto reset or a manual reset, push-to-trip
- Panel mount with 1/4-28 stainless steel studs
- Waterproof

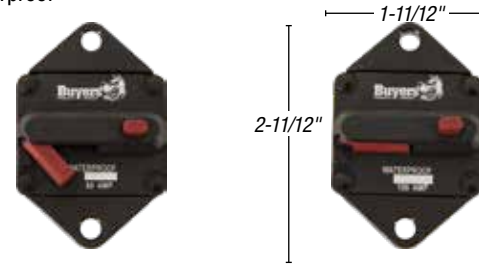

Part No.	Amps	Description	Cat.
CB62PB	60	Manual Reset, Push-to-Trip	560 (N)
CB102PB	100	Manual Reset, Push-to-Trip	560 (N)
CB152PB	150	Manual Reset, Push-to-Trip	560 (N)
CB202PB	200	Manual Reset, Push-to-Trip	560 (N)

Hi-Amp Large Frame Circuit Breakers

- For cranes, dump hoists, liftgates, plows, spreaders, etc.
- Auto reset or a manual reset, push-to-trip
- 3/8" silver plated steel studs and nuts with rubber boots provide additional clearance for heavy gauge connectors
- Waterproof

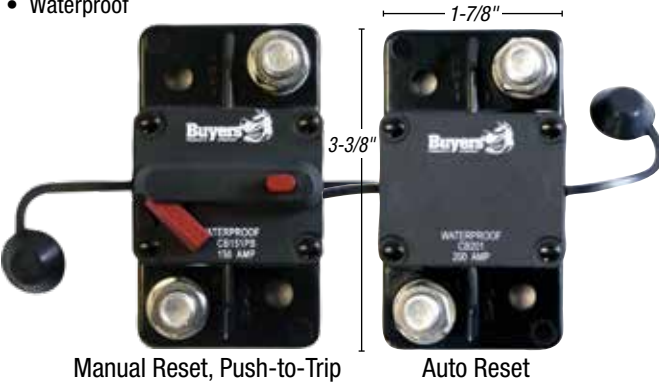

Part No.	Amps	Action	Cat.
CB151	150	Auto Reset	560 (N)
CB151PB	150	Manual Reset, Push-to-Trip	560 (N)
CB201	200	Auto Reset	560 (N)
CB201PB	200	Manual Reset, Push-to-Trip	560 (N)
CB62PB	60	Manual Reset, Push-to-Trip	560 (N)
CB102PB	100	Manual Reset, Push-to-Trip	560 (N)
CB152PB	150	Manual Reset, Push-to-Trip	560 (N)
CB202PB	200	Manual Reset, Push-to-Trip	560 (N)
CB251PB	250	Manual Reset, Push-to-Trip	560 (N)

Counter Clockwise Rotation Motor



Part No.	Description	Cat.
M3100	12 Volt D.C. Motor Less Drive End, Tang Shaft	639 (N)

Bi-Rotational Motor



Part No.	Description	Cat.
M3300	12 Volt, DC Motor	639 (N)

Solenoids and Motors

Clockwise Rotation Motor with Spline Output Shaft



Part No.	Description	Cat.
M3400	12 Volt D.C. Motor with 9-Spline Output Shaft	639 (N)

Canister Type Solenoid



- Push for ON, Spring return for off
- 5/16"-24 Thd. terminals
- 1" diameter mounting hole
- Fits through 1/4" panel thickness
- Button extends 1" above faceplate

Part No.	Description	Cat.
B63322	Solenoid - Canister	639 (N)

Continuous Duty 12 Volt Plastic Case Solenoid (Insulated)

- Waterproof, sealed design
- 11/32" holes, 3" on center
- 5/16"-24 Thd. terminals
- 10-32 coil terminals



Part No.	Description	Cat.
1306317	Solenoid, 12V, Motor Relay, Continuous	639 (N)
1304719	Solenoid, 12V, 150 AMP, Motor Relay, Intermittent	639 (N)

Intermittent 12 Volt Plastic Case Solenoid (Insulated)

- 5/16"-24 Thd. terminals
- 9/32" x 25/64" holes, 27/64" on center



Part No.	Description	Cat.
1306070	Intermittent-duty, +12V to Activate	639 (N)
1306300	Intermittent-duty, GND to Activate	639 (N)

Solenoid Switch Kit



- 150 AMPS, grounded coils
- Alloy silver-plated contact material, intermittent-duty
- Ideal for any application that requires reversing motion (truck winch, tarp systems, boat lifts, RV slide-out, RV leveling systems)

Part No.	Description	Cat.
1306600	Solenoid, grounded, Reversing Polarity	639 (N)
3014186	Plastic Cover for 1306600	639 (N)

12 Volt Steel Case Solenoid (Insulated)



- Continuous-duty
- 5/16"-24 thread terminals
- Ground connection applied to center terminal activates solenoid
- Compares to Cole-Hersee® #24059

Part No.	Description	Cat.
1306515	Solenoid, Steel, 12V, Continuous Duty	639 (N)

Grounded 12 Volt Steel Case Solenoid (Insulated)



- **B98596:**
- Continuous-duty
- 5/16"-24 Thd. terminals
- 12 volts applied to center terminals activates solenoid
- **1306505:**
- Continuous-duty
- 5/16"-24 thread terminals
- 29/32" x 25/64" holes, 27/64" on center
- Ground connection applied to center terminal activates solenoid

Part No.	Description	Cat.
B98596	Solenoid-Steel Case with Slots	639 (N)
1306505	Solenoid, Steel, Ground-Activate	639 (N)

Clockwise Rotation Motor



Part No.	Description	Cat.
M3200	12 Volt D.C. Motor Less Drive End Tang Shaft	639 (N)

Hour Meter



- Low power, low cost reliable hour meter with quartz timing
- Compact, tamper proof meter is sealed against moisture and dirt
- Mechanical indicating counter requires no battery
- 2.75" dia. x 1.875" deep

Part No.	Description	Cat.
B40B45	10-80V DC Hour Meter	630 (N)

Master Battery Isolator Switch



- Rated 100 amps continuous, 500 amps surge, at 12 volts
- Four 3/16" diameter mounting holes
- Key and water resistant cover included

6391201
replacement key

Part No.	Description	Cat.
6391200	Master Battery Disconnect Switch	639 (N)

Dual Battery Isolator Switch



- 1000 Amp Surge/300 Amp Continuous for 5 Seconds
- 12-28 VDC
- IP54 Rated
- Silver Plated Contacts

Part No.	Description	Cat.
6391050	Dual Battery Isolator Switch, 300A	639 (N)

Locking Battery Disconnect Switch



- 2500 Amp Surge/250 Amp Continuous for 5 Seconds
- 12-24VDC
- Complies with OSHA 1910.147 Lock-out/Tag-out

Part No.	Description	Cat.
6391005	Battery Disconnect Switch, Dual, 250A	639 (N)

Brass Battery Bolt Adapters, Bulk

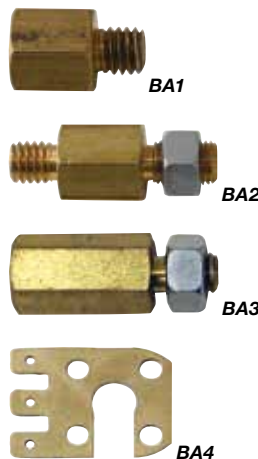

- Organize and protect battery connections
- Reduce corrosion of battery and connections
- Reduce warranty claims
- Replaces standard battery bolts
- Attach lights, backup alarms, lift gates, plows, spreaders, winches, etc.

Part No.	Description	Cat.
BA1	Bolt, Brass, Side Terminal, 3/8-16	520 (N)
BA2	Bolt, Brass, Side Terminal, 3/8-24	520 (N)
BA3	Bolt, Brass, Top Term, Bulk with Nut	520 (N)
BA4	Bolt, Brass, Terminal Tap & Ground, Side Mount Bulk	520 (N)

Dual Fuse Holders

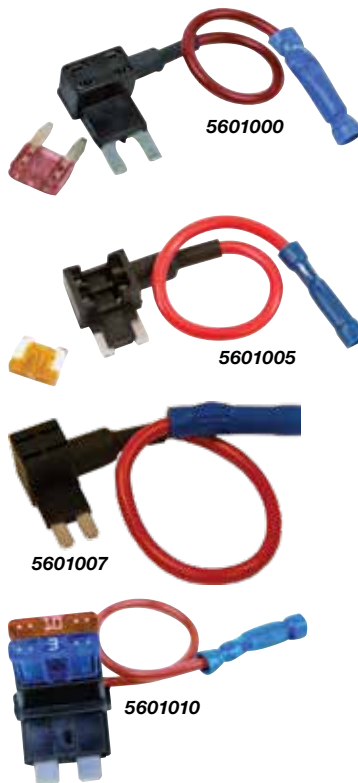

- Turns one fuse slot into two
- Fuse not included.

Part No.	Description	Cat.
5601000	Dual Fuse Holder Dual ATM Mini Fuse Holder 10 Amp Main, 5 Amp Added	639 (N)
5601005	Dual Fuse Holder Dual ATM Type Low Profile, 10 Amp Main, 5 Amp Added	639 (N)
5601007	Dual Fuse Holder Dual ATR Type Micro, 10 Amp Main, 5 Amp Added	639 (N)
5601010	Dual Fuse Holder Dual ATO/ATC Fuse Holder 10 Amp Main, 5 Amp Added	639 (N)

Junction Boxes



Part No.	Description	Cat.
5601100	PP Electrical Junction Box with 7 Terminals 8-3/8"L x 3-7/8"W x 2-3/8"T	639 (N)
5601101	ABS Electrical Junction Box with 7 Color-Coded Terminals, Retail Packaged 8"L x 3-1/4" W x 2-3/16" T	639 (N)

6-Way Fuse Block With Cover



- For use with ATC/ATO blade-type fuses (fuses not included)
- 25 Amps max per circuit with 150 Amp max per block
- Includes two tin-plated copper 10-32 studs and six tin-plated copper terminal screws
- Clear polycarbonate removable cover for easy viewing

Part No.	Description	Cat.
5601006	6-Way Fuse Block with Cover	639 (N)

Low Voltage Battery Protector



- 12 Volt 20 Amp solid state
- Over current protection
- 4-wire terminal
- Compact size
- Durable metal case

Part No.	Description	Cat.
5601012	Disconnect, Power, Voltage, Low, 5 Min	639 (N)

Electric Converter



- Convert 110C AC to 12V DC
- 5A Output
- 1/4" MQD(-), 1/4" FQD(+)
- Perfect for showroom displays

Part No.	Description	Cat.
3023432	Electric Adaptor	639 (N)

TRUCK EQUIPMENT & ACCESSORIES

Buyers provides you with all the equipment and add-ons you'll need to get the job done.



DUMPERDOGG DUMP INSERTS	E2
LIFTDOGG™ LIFT GATES	E4
ATV / UTV ALL SEASON SPREADERS	E5
NEW Tow Behind Broadcast Spreader	E5
ELECTRIC WINCHES	E6
KABGARD™ CAB GUARDS	E7
LADDER RACKS AND ACCESSORIES	E8
NEW Steel and Aluminum Truck Ladder Racks	E8-E10
CONDUIT CARRIERS	E11
LANDSCAPE TRAILER EQUIPMENT	E12
CLAMPS, CARRIERS AND HOLDERS	E16
NEW Stake Pocket Spare Tire Carrier	E17
NEW Document Holder with Clear Cover	E17
FENDERS AND ACCESSORIES	E18
NEW Full Radius Poly Fenders	E18
MUDFLAPS AND SPLASH GUARDS	E20
SIGHT GUIDES	E24
NEW Illuminated LED Sight Guides	E24
BULK STORAGE TANKS	E25
OUTRIGGER PADS	E27
NEW UHMW Poly Outrigger Pad	E27
WHEEL CHOCKS	E28
NEW Steel Motorcycle Wheel Chock	E33
WORK WEAR	E34

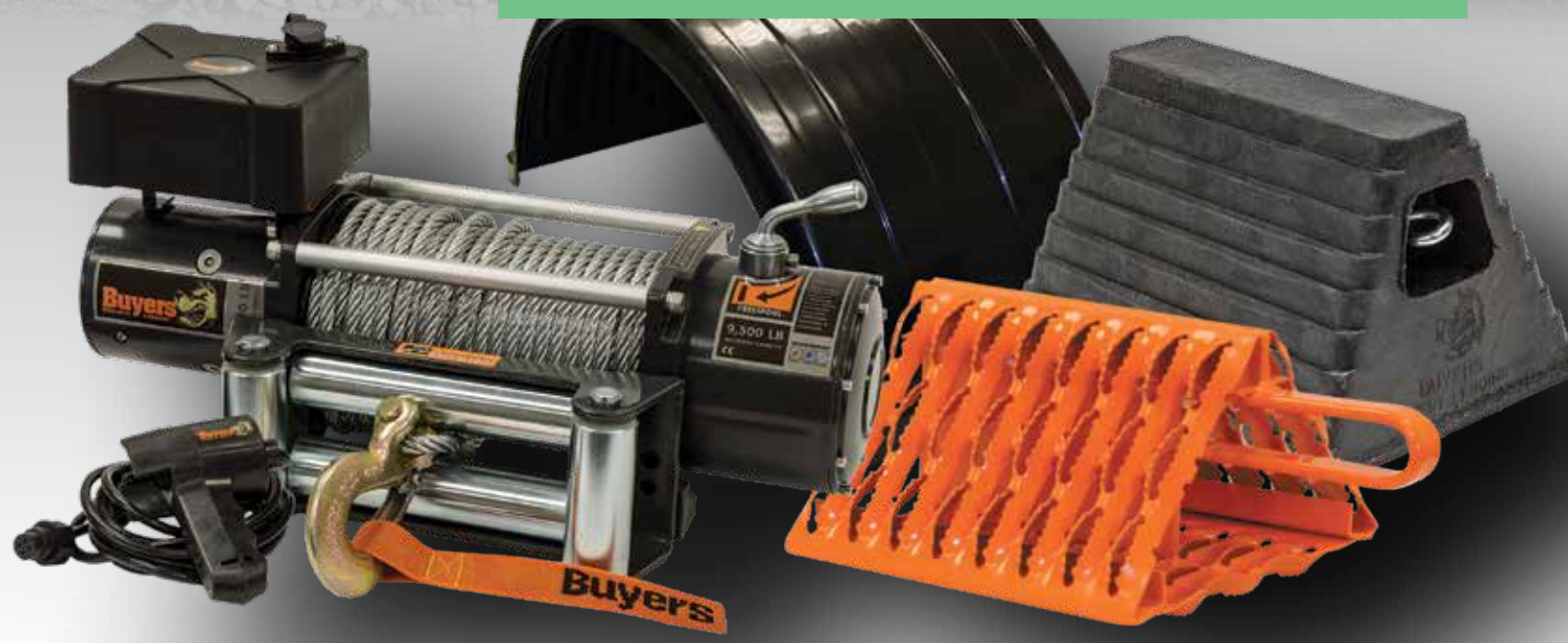

DumperDog[®] Dump Inserts

All DumperDog[®] Features

- 20 ft. battery cables
- Tailgate chains with vinyl mesh covers
- Body-up indicator kit (SK10)



SPECIFICATION	6 FT STEEL DUMPERDOGG	6 FT STAINLESS STEEL DUMPERDOGG	8 FT STEEL DUMPERDOGG	8 FT STAINLESS STEEL DUMPERDOGG	8 FT POLYMER DUMPERDOGG
Part Number	5531006	5534006	5531000	5534000	5532000
Category	553 (Y)	553 (Y)	553 (Y)	553 (Y)	553 (Y)
Bed Floor Size	48.25" x 78.5"	48.25" x 78.5"	48.25" x 97"	48.25" x 97"	36" x 89.75"
Overall Dimensions (HxWxD)	26" x 72" x 82"	26" x 72" x 82"	26" x 72" x 102"	26" x 72" x 102"	43" x 70" x 101"
Volume Capacity	1.5 cu. yd.	1.5 cu. yd.	2.0 cu. yd.	2.0 cu. yd.	3.1 cu. yd.
Max Payload Capacity*	6,000 lbs.	6,000 lbs.	6,000 lbs.	6,000 lbs.	6,000 lbs.
Weight	920lbs.	988 lbs.	986 lbs.	875 lbs.	1,115 lbs.
Body Construction	Black powder coated 12 Gauge Steel	12 Gauge 304 Stainless	Black powder coated 12 Gauge Steel	12 Gauge 304 Stainless	Double Wall Polymer with integral side extensions
Frame Construction	Black Powder Coated Structural Steel Frame				
Dump Angle	0° – 45°				
Tailgate	Double Pivoting and Removable with Four 3/4" Diameter Hinge Pins				
Lift	Double Acting Scissor Hoist with 3HP Monarch Power Unit				
Hydraulics/Cylinder	4-1/2" x 8" Power Up/Power Down Cylinder				
Control Box	Tethered Control Box with 10 ft. Cord				
Lubrication	Grease Holes and Fittings at Pivot Points				

OPTIONAL ACCESSORIES

Cab Guard	5531010	5534010	5531010	5534010	Included
Side Wall Extensions	5531020	5534020	5531020	5534020	Included
Tarp Kit	DTR5508	DTR5508	DTR5511	DTR5511	DTR4510

*Weight limits not to exceed manufacturers gross vehicle weight limits. **Must use with steel/stainless steel DumperDog[®] cab guard.



Cab Guards for DumperDogg®



5531010

Part No.	Description	Wt. (lbs.)	Cat.
5531010	Steel Bolt-On Cab Guard (use with Steel Inserts)	83	553-1 (Y)
5534010	Stainless Steel Bolt-On Cab Guard (use with Stainless Steel Inserts)	55	553-1 (Y)

Side-Wall Extension Brackets for DumperDogg®



5531020



5534020



5531020 shown with 2' x 12" boards

Part No.	Description	Wt. (lbs.)	Cat.
5531020	Steel Side-Wall Extension Bracket Kit. 2 Brackets/Side, Hardware Included. (use with Steel Inserts)	15	553-1 (Y)
5534020	Stainless Steel Side-Wall Extension Bracket Kit. 2 Brackets/Side, Hardware Included. (use with Stainless Steel Inserts)	15	553-1 (Y)

Must be used with cab guard installed. 2' x 12' board not included.

Roll Tarp Kits for DumperDogg®



DTR5511

Part No.	Description	Wt. (lbs.)	Cat.
DTR5508	Roll Tarp Kit, 5.4'W x 9.5'L for 6' Steel/Stainless Steel Inserts (Must be used with Cab Guard Installed)	24	554 (Y)
DTR5511	Roll Tarp Kit, 5.4'W x 11.5'L for 8' Steel/Stainless Steel Inserts (Must be used with Cab Guard Installed)	25	554 (Y)
DTR4510	Roll Tarp Kit, 4.6'W x 10'L for 8' Poly Insert	23	554 (Y)

Replacement Tailgate Spreader



- Fits all DumperDogg® Dump Inserts
- All stainless steel construction won't rust or corrode
- 12VDC Spinner Motor 54 AMP/ 620 RPM
- 12VDC Auger Gear Motor 50 AMP/ 30 RPM/ 1042 in lbs.
- Adjustable spread pattern from 4' to 20' of rock salt, free-flowing granular materials or de-icer chemicals
- Includes in-cab, independent variable spinner speed control & auger control
- Dual-flight augers (5" O.D. x 2.4" I.D. x 20"L) with mixing tines
- 14" Poly spinner
- Overall dimensions 64.5" W x 31" H x 16.5" D
- Quick and Easy 4-pin installation.

Part No.	Description	Wt. (lbs.)	Cat.
5535000	Tailgate Replacement Spreader	291	553 (Y)



LiftDogg™ Lift Gates

Pickup Truck Lift Gates

- 1,300 lb. capacity
- 12V DC, electric hydraulic Monarch™ power unit with built-in pressure relief
- Keyed, security switch operation standard (Remote control pendant optional)
- Twin, chrome plated direct-lift cylinders
- 40" floor-to-ground travel height
- Tread plate steel platform surfaces

- Torsion spring platform assist
- Platform folds down for simple dock and forklift loading
- 4" tapered ramp edge
- Accommodates spare tire and frame mounted hitches
- Recessed license plate housing with LED light
- Battery cable & circuit breaker included
- Greasable pivot joints
- Durable black powder coat finish

Pickup Lift Gate (One Piece)

Pickup Lift Gate (Two Piece)



13006039



13006027

5051000 optional

Part No.	Description	Wt. (lbs.)	Cat.
13006027	One Piece Lift Gate (60"W x 27"D Platform)*	450	505 (Y)
13006039	Two Piece Lift Gate (60"W x 39"D Platform)*	500	505 (Y)
5051000	Lift Gate Remote Control Pendant, Optional	1.2	505-1 (N)

*Truck mounts sold separately

LiftDogg™ Mounts



- LiftDogg™ mounts are make and model specific
- Made from carbon steel
- Black powder coat finish

Part No.	Manufacturer	Body Style	Year	Wt. (lbs.)	Cat.
5051100	Chevy/GMC	C/K 1500 (Classic)	2007	38.6	505-1 (N)
	Chevy/GMC	C/K 2500/3500 (Classic)	2007	38.6	505-1 (N)
	Chevy/GMC	C/K 1500 (Not Classic)	1999-2006	38.6	505-1 (N)
	Chevy/GMC	C/K 2500/3500 (Not Classic)	2001-2006	38.6	505-1 (N)
	Chevy/GMC	C/K 2500 (Not Classic)	1999-2000	38.6	505-1 (N)
5051105	Chevy/GMC	C/K 1500 (Not Classic)	2007-2018	38.6	505-1 (N)
	Chevy/GMC	C/K 2500/3500 (Not Classic)	2007-2019	38.6	505-1 (N)
5051200	Ford	F-250 HD/F-350 HD	1997	43.1	505-1 (N)
	Ford	F-150, F-250, F-350	1973-1996	43.1	505-1 (N)
5051205	Ford	F-150	1997-2014	35.5	505-1 (N)
	Ford	F-250 LD	1997-1999	35.5	505-1 (N)
5051206	Ford	F-150	2015+		505-1 (N)
5051207	Ford	F-250, F-350	2017+	59.5	505-1 (N)
5051210	Ford	Super Duty Series	1999-2016	38.5	505-1 (N)
5051300	Dodge/RAM	2500/3500	2003-2019	47.5	505-1 (N)
	Dodge/RAM	1500	2002-2018	47.5	505-1 (N)
5051400	Toyota	Tundra T-50	2007-2019	30.0	505-1 (N)

ATV All Purpose Spreader, Rack Mount

- Rust-proof, poly hopper
- Heavy-duty, sealed 12V motor
- Direct linkage controls eliminates stretching/breaking cable
- Rain cover included
- Multi-purpose design: you can salt, fertilize, broadcast seed & feed game
- Manual feed gate regulator
- Spreader frame mounts horizontally on ATV utility rack



ATVS100

Tow Behind Broadcast Spreader

- Comes with a tow-bar for small tractors, utility vehicles and ATVs
- Large single flow gate for use with bulk and bagged material
- Spread range up to 24'
- 1.5 cubic ft. hopper can hold as much as 100 lbs
- Rugged construction with a black powder-coated steel frame
- 13" pneumatic tires and solid axle
- Flow regulator with solid control linkage
- Hitch pin included
- Backed with a 1 year warranty on parts and labor



TB150BG

Part No.	Description	Wt. (lbs.)	Cat.
 ATVS100	100 lb. Capacity	19	537 (N)

Part No.	Description	Wt. (lbs.)	Cat.
 TB150BG	100 lb. Capacity	31	903-3 (N)

ATV All Purpose Spreaders, Receiver Mount

- Durable polymer hopper
- Black powder coated steel framework, resists rust & corrosion
- Quick detach mounting bracket
- Hopper empties completely
- Multi-purpose design: you can salt, fertilize, broadcast seed & feed game



- Adjustable shut-off gate regulates amount dispersed
- Spread 25'– 30'
- Fits 2" receiver hitch (UTVS16 only)
- Spreader frame mounts vertically on ATV tubular utility rack (ATV15A)



UTVS16



ATVS15A

Part No.	Description	Wt. (lbs.)	Cat.
 ATVS15A	15 Gallon Capacity	39	537 (N)
 UTVS16	15 Gallon Capacity with 2" Receiver Connection	57.5	537 (N)



Electric Winches & Accessories

Electric Winch



- Commercial grade 12V electric winch
- Commonly used on utility, government or contractor fleet vehicles (pickups & utility bodies)
- 4.9 HP series wound motor
- High speed 3-stage planetary gear box provides quick, efficient 6.2 FPM line speed at full capacity (5579500) 4.9 FPM (5571200)
- Gear Ratio: 210:1 (5579500), 294:1 (5571200)
- 3/8" x 100' galvanized cable with 4-way roller fairlead
- Waterproof submersible construction (IP68) seals and protects electronics and internals for reliable use in all environments
- Free spooling clutch provides quick manual deployment of cable
- 8 "clockable" gear housing positions to rotate clutch lever
- Auto-Brake
- Power in & out provides consistent load control
- 12' remote control pendant with rubber housing
- 10" x 4.5" Universal mounting bolt pattern
- Ships UPS

5571006 optional

Part No.	Description	Wt. (lbs.)	Cat.
5579500	9,500 lb., 6.2 FPM, 210:1 Gear Ratio	81	557 (N)
5571200	12,000 lb., 4.9 FPM, 294:1 Gear Ratio	83	557 (N)

Electric Winch Accessories



Part No.	Description	Wt. (lbs.)	Cat.
5571000	Wireless Remote	0.53	557 (N)



Part No.	Description	Wt. (lbs.)	Cat.
5571001	Snatch Block (20,000 lb.)	4.13	557 (N)



Part No.	Description	Wt. (lbs.)	Cat.
5571002	3/4" Shackle	2.28	557 (N)



Part No.	Description	Wt. (lbs.)	Cat.
5571003	Universal Mount	28.83	557 (N)



Part No.	Description	Wt. (lbs.)	Cat.
5571004	Jeep Mount (hardware included)	20.13	557 (N)



Part No.	Description	Wt. (lbs.)	Cat.
5571005	2" Receiver Mount	25.58	557 (N)



Part No.	Description	Wt. (lbs.)	Cat.
5571006	Handheld Controller, 30' Cord	2.56	557 (N)



Part No.	Description	Wt. (lbs.)	Cat.
5571007	25' Aux. Trailer Wiring Harness	10.2	557 (N)



Part No.	Description	Wt. (lbs.)	Cat.
5571008	Roller Fairlead	10.64	557 (N)



Part No.	Description	Wt. (lbs.)	Cat.
3025777	Clevis Slip Hook	0	557 (N)

Kabgard™ Protectors



- Protect your cab
- Mount accessories
- Secure your cargo
- Quick installation- mounts included
- Black powder coat finish resists rust and corrosion
- Ships UPS

Part No.	Description	Wt. (lbs.)	Cat.
85104	Kabgard™ (69" x 23.5") with Standard Mount	46.24	540 (Y)
85204	Kabgard™ (71.6" x 26.3") with Standard Mount	53.10	540 (Y)
85106	Standard Kabgard™ Mounting Kit (included in 85104 & 85204)	9.43	540 (Y)

Application Guide

Part No.	Manufacturer	Body Style	Year
85104	Chevy/GMC	1500 Reg. Cab, Ext. Cab & Crew Cab	1999+
	Chevy/GMC	2500 Reg. Cab, Ext. Cab & Crew Cab	1999+
	Ford	F-150	1997+
	Ford	F-250/350 Super Duty Reg. Cab	1997-1999
	Dodge/Ram	1500 Reg. Cab	1997-2001
	Dodge/Ram	1500 Quad Cab	1997-2000
	Dodge/Ram	1500 Quad Cab, (155" wheel base only)	2001
85204	Dodge/Ram	2500 Reg. Cab	1997-2001
	Chevy/GMC	2500HD (all cab styles)	2003+
	Chevy/GMC	3500 (all cab styles)	2003+
	Ford	F-250 Super Duty Reg. Cab, Super Cab & Crew Cab	2003+
	Ford	F-350 Super Duty Reg. Cab, Super Cab & Crew Cab	2003+
	Dodge/Ram	1500 Quad Cab	2001+
	Dodge/Ram	2500 Reg. Cab	2002+
	Dodge/Ram	3500 Reg. Cab & Quad Cab	2003+
	Dodge/Ram	3500 Mega Cab	2006

Kabgard™ Accessories



- Works with Kabgard™ window protector for mounting a cross body truck box.

Part No.	Description	Wt. (lbs.)	Cat.
85162	Cross body Truck Body Adapter	11.91	540 (Y)



Part No.	Description	Wt. (lbs.)	Cat.
85141	Beacon Light Mount, DS	3.50	540 (Y)
85142	Beacon Light Mount, PS	3.50	540 (Y)
85152	Mini Lightbar Mount	5.80	540 (Y)



Part No.	Description	Wt. (lbs.)	Cat.
85166	Post-Mount Light Mount (Pair)	1.24	540 (Y)
85177	Full-Size Lightbar Mount (Pair)	4.67	540 (Y)
85176	Traffic Arrow Lightbar Mount (Pair)	1.19	540 (Y)
851105	Kabgard 5 Position Tool Holder	11.91	541 (Y)
851111	Kabgard 11 Position Tool Holder	22.43	541 (Y)



Ladder Racks

Heavy Duty Steel Pickup Ladder Rack



- Fits full-sized pickup trucks with 5.5' to 8' beds
- Black powder coat with rust inhibiting e-coat
- Integrated no-drill mounting system
- Over cab design
- Built-in grab handles at rear
- (4) Crossbars, (2) fixed, (1) adjustable, (1) removable
- Removable rear crossbar (no tools required)*
- Built-in tie points

Part No.	Description	Capacity (lbs.)	Wt. (lbs.)	Cat.
NEW 1501150	11.5' x 56" x 36"	1,000	81	540 (Y)

*Late model Chevy/GMC trucks require drilling at rear corners

Heavy Duty Steel Service Body Ladder Rack



- Fits both single & dual rear wheel utility compartments
- Can be mounted on top of compartments or front & back
- Adjustable height accommodates 21" - 31" range
- Black powder coat with rust inhibiting e-coat
- Over cab design
- Built-in grab handles at rear
- (4) Crossbars: (2) fixed, (1) adjustable, (1) removable
- Removable rear crossbar (no tools required)
- Built-in tie points
- Additional adjustable cross bars optional



Part No.	Description	Capacity (lbs.)	Wt. (lbs.)	Cat.
NEW 1501250	13.5' x 66" x 21-30"	1,000	155	540 (Y)
NEW 1501260	14.5' x 66" x 21-30"	1,000	159	540 (Y)
3028368	Optional CrossBar with Hardware Kit, Black (use with 1501250 & 1501260)		9	540 (Y)

Truck Window Screens

1501105

- Black powder coat finish
- 15 gauge, CNC formed steel
- 24"H x 57"W top, 70"W bottom

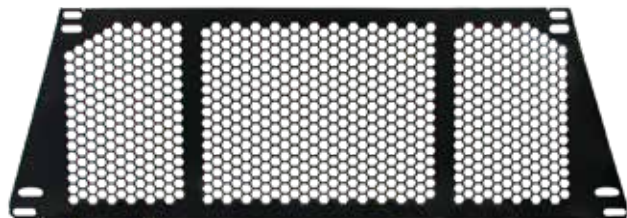

1501110

- Black powder coat finish
- 15 gauge, CNC formed steel
- 19"H x 62"W

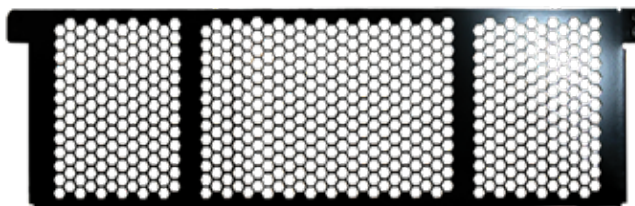

Part No.	Description	Wt. (lbs.)	Cat.
1501105	Pickup Window Screen (use with 1501150)	18	540 (Y)
1501110	Service Body Window Screen, Black (use with 1501250 & 1501260 Utility Racks)	19	540 (Y)

Universal Steel Pickup Rack



- **FITS MOST MAKES & MODELS**
- Over-cab design accommodates large ladders and loads up to 500 lb
- Easy, drill-free installation using only simple tools*
- Durable, corrosion-resistant black powder-coated steel construction
- Tie downs sold separately

Part No.	Description	Capacity (lbs.)	Wt. (lbs.)	Cat.
NEW 1501550	6.5' x 77" x 33", Black	500	52	540 (Y)

*Late model Chevy/GMC trucks require drilling at rear.

Aluminum Full Size Ladder Rack



- **FITS MOST MAKES & MODELS**
- Cab-over design accommodates large ladders and loads up to 800 lb
- Easy, drill-free installation using only simple tools*
- Comes standard with four load mounts/stops that can be adjusted to secure your cargo
- Durable, corrosion-resistant anodized aluminum construction
- Includes zinc-plated hardware for corrosion resistance
- Tie downs sold separately

Part No.	Description	Capacity (lbs.)	Wt. (lbs.)	Cat.
NEW 1501400	11.5' x 76-3/8" x 35", Clear Anodized Aluminum	800	99	540 (Y)
NEW 1501410	11.5' x 76-3/8" x 35", Black Powder Coat Aluminum	800	99	540 (Y)

*Late model Chevy/GMC trucks require drilling at rear.

Ladder Rack Wind Deflector Kit



- 40" in length
- 3 - Ring stainless steel clamps included for mounting to front crossbar
- Reduces wind noise

Part No.	Description	Wt. (lbs.)	Cat.
1501193	Wind Deflector, Black (use with 1501150, 1501250, 1501260, 1501310, 1501550)	3.6	540 (Y)



Ladder Racks

Aluminum Truck Ladder Rack



1501680



1501675

- Over-cab design accommodates large ladders and loads up to 800 lb
- Easy, drill-free installation using only simple tools
- Comes standard with four load mounts/stops that can be adjusted to secure your cargo
- Durable, corrosion-resistant aluminum construction
- Includes zinc-plated hardware for corrosion resistance
- Tie downs sold separately

Part No.	Description	Capacity (lbs.)	Wt. (lbs.)	Cat.
1501675	6.5' x 76" x 28" Natural Finish Aluminum	800	44	540 (Y)
1501680	6.5' x 76" x 28" Black Powder Coated Aluminum	800	44	540 (Y)



Van Ladder Rack



- Mounts to rain gutter, universal fit
- 6" wide gutter clamps - 3/16" thick plate steel
- 1-1/2" & 1-1/4" square 14-gauge steel tubing
- Easy to install
- Adjustable widths: 41" to 72"
- White powder coat finish
- Ships UPS in 1 box



Part No.	Description	Capacity (lbs.)	Wt. (lbs.)	Cat.
1501310	Van Rack Set (2 Bars, 2 Clamps)	600	41.5	540 (Y)
1501311	Optional Third Bar with Clamps (use with 1501310)	600	23	540 (Y)



PVC Conduit Carrier Kit



- For use with 4", 6" or 8" diameter PVC (PVC not included)
- Kit Includes: Cast aluminum door & end cap, saddle brackets, zinc-plated U-bolts and hardware
- Spring loaded latching mechanism for quick, easy access
- Pre-drilled padlock tabs for security (padlock not included)
- Neoprene gasket on door to keep your interior dry
- Designed for use with ladder racks, this flexible kit can be built to accommodate any desired length

Part No.	Description	Wt. (lbs.)	Cat.
CC400	4" Diameter PVC Conduit Carrier	4	540 (Y)
CC600	6" Diameter PVC Conduit Carrier	6.5	540 (Y)
CC800	8" Diameter PVC Conduit Carrier	8.25	540 (Y)

Conduit pipe not included

PVC Conduit Carrier Replacement Parts



Part No.	Description	Wt. (lbs.)	Cat.
Parts for CC400			
3016367	Cap, 4" Conduit	0.72	540 (Y)
3016369	Saddle, 4" Conduit Carrier	0.38	540 (Y)
3016371	U-Bolt, RD, 4-1/2" x 6-1/2" with 2-1/2" of 3/8-16THD.	0.42	540 (Y)
3016383	Cover Assy, 4" Conduit	1.9	540 (Y)
3006554	Hardware Kit, Conduit Carrier	0.31	540 (Y)
Parts for CC600			
3016366	Cap, 6" Conduit	1.09	540 (Y)
3016368	Saddle, 6" Conduit Carrier	0.57	540 (Y)
3016370	U-Bolt, RD, 6-5/8" x 9-3/4" with 3" of 3/8-16THD.	0.61	540 (Y)
3016382	Cover Assy, 6" Conduit	2.6	540 (Y)
3006554	Hardware Kit, Conduit Carrier	0.31	540 (Y)
Parts for CC800			
3025858	Cap, 8" Conduit	1.15	540 (Y)
3025860	Saddle, 8" Conduit Carrier	0.15	540 (Y)
3025859	U-Bolt, RD, 8-5/8" x 11-3/4" with 3" of 3/8-16THD	0.12	540 (Y)
3025864	Cover Assy, 8" Conduit	3.9	540 (Y)
3006554	Hardware Kit, Conduit Carrier	0.31	540 (Y)

Diamond Tread Aluminum Conduit Carrier



- Provides fully enclosed storage for conduit, pipe, tubing, etc.
- Kit Includes: two-piece design (for shipping & storage) and mounting brackets for round or square bars
- Lock hasp (lock not included)
- .060 diamond tread aluminum construction
- 3 pieces for easy shipment

Part No.	Description	Wt. (lbs.)	Cat.
5401000	121-3/8"L x 11"W x 6"H	40	540 (Y)

Landscape Trailer Racks

3-Trimmer Locking Rack



- Holds 3 trimmers (not included)
- Includes vinyl-coated hooks
- Easy, snap-in design; one-hand operation
- Includes locking device
- Long-lasting stainless steel springs
- LT10 secures with padlock (not included)

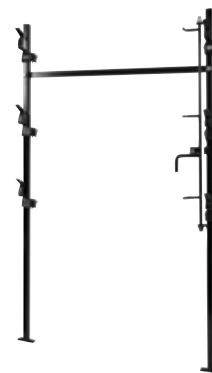

Part No.	Description	Trailer Type	Wt. (lbs.)	Cat.
LT10	3-Position Snap-in Lockable Trimmer Rack	Open	25.0	538 (Y)
3004090	Trimmer Rack Lock for LT10	-	2.13	538 (Y)

3-Trimmer Enclosed Truck/Trailer Rack



- Holds 3 trimmers (not included)
- Vinyl-coated hooks protect from scratches
- Easy, snap-in design for one-hand operation
- Long-lasting stainless steel springs
- Trimmers not included



Part No.	Description	Trailer Type	Wt. (lbs.)	Cat.
LT12	3-Position Snap-in Trimmer Rack	Enclosed	14.7	538 (Y)

3-Trimmer Locking Rack with Padlocks



- Heavy-duty vinyl-coated
- 3 position lockable trimmer rack
- Channel and flat pin design is adjustable to 3 settings to reduce rattle
- **Set includes 2 trimmer racks, 6 securing pins, 3 locks and mounting hardware**
- Trimmers not included



Part No.	Description	Trailer Type	Wt. (lbs.)	Cat.
LT13	3-Position Channel Style Lockable Trimmer Rack	Open	23.0	538 (Y)

Multi-Rack for Trailers (Chainsaw, hedge trimmers, hand blower)



- Protects hedge trimmers, chainsaws, or handheld blowers
- Includes rubber straps to secure equipment
- Chainsaw not included



Part No.	Description	Trailer Type	Wt. (lbs.)	Cat.
LT15	Multi-Rack	Both	15.0	538 (Y)

Backpack Blower Rack



- Blowers mount and secure conveniently on hook with spring latch
- Includes rubber strap to secure equipment (not for *STIHL® BR-Series)
- Blower not included

Part No.	Description	Trailer Type	Wt. (lbs.)	Cat.
 LT20	Backpack Blower Rack	Both	7.0	538 (Y)

Stihl® BR Series Blower Rack



- Designed specifically for *STIHL® BR340 , BR380, BR420 & BR440 blowers
- Blower rests on bottom support and is secured on top hang pin
- Secures with padlock
- Padlock & blower not included

Part No.	Description	Trailer Type	Wt. (lbs.)	Cat.
 LT22	Backpack Blower Rack (for Stihl Blowers)	Both	6.5	538 (Y)

Water Cooler Racks



LT25



5201005

- Holds most standard coolers
- Adjustable strap included
- Water cooler not included

Part No.	Description	Trailer Type	Wt. (lbs.)	Cat.
 LT25	Water Cooler Rack	Both	6.5	538 (Y)
5201005	White Water Cooler Mount, Fits a Standard 3 to 5 Gallon Water Cooler	—	7.92	538 (Y)

Gas Container Rack



- Holds one 5-gal. or two 2-1/2-gal. rectangular polymer cans (not included)
- Includes rubber strap to secure can(s)
- Gas can not included

Part No.	Description	Trailer Type	Wt. (lbs.)	Cat.
 LT30	Gas Can Rack	Both	12.0	538 (Y)

*Buyers Products is not authorized by nor affiliated with the manufacturer of Stihl® products.



Landscape Trailer Racks

Locking Gas Container Rack



- Holds one 5-gallon gas can (not included)
- Includes lock and steel pin to lock gas can in place
- Powder coated steel construction
- Includes mounting hardware
- Gas can not included

Part No.	Description	Trailer Type	Wt. (lbs.)	Cat.
LT32	Locking Gas Can Rack	Both	11.4	538 (Y)

Vertical Hand Tool Rack



- Holds up to 6 straight handle tools (not included)
- Keeps tools organized and trailer bed clutter-free
- Includes rubber grommets to protect tools
- Mounts to open-style trailers

Part No.	Description	Trailer Type	Wt. (lbs.)	Cat.
LT35	Hand Tool Rack	Open	15.0	538 (Y)

Horizontal Hand Tool Rack

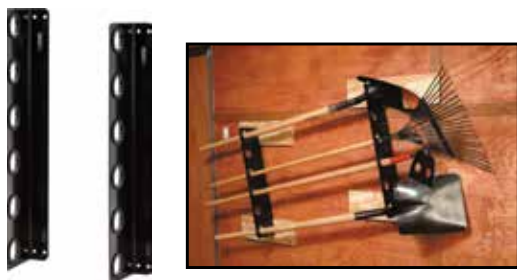

- Holds up to 6 straight handle tools (not included)
- Keeps tools organized and trailer bed clutter-free
- Includes rubber grommets to protect tools
- Mounts to closed-style trailers

Part No.	Description	Trailer Type	Wt. (lbs.)	Cat.
LT37	Hand Tool Rack	Enclosed	9.0	538 (Y)

Trimmer Line Spool Bracket



- Holds one 3 lb. or 5 lb. line spool (not included)
- Powder coated steel construction
- Mounting hardware included
- Trimmer line not included

Part No.	Description	Trailer Type	Wt. (lbs.)	Cat.
LT40	Trimmer Line Spool Bracket	Both	3.1	538 (Y)

EZ Gate™ Tailgate Assist Patented



Buyers Products EZ Gate™ Tailgate Assist reduces the physical strain from lifting and lowering heavy trailer tailgates by up to 90%. The spring-loaded mechanism mounts to your trailer's side rail and attaches to the tailgate, taking most of the gate's weight off the user's hands. It also leaves the other side of the trailer open for equipment racks and other rail-mounted trailer accessories.

The EZ Gate works on most open utility trailers with square or round tubing and a side rail height of 10" to 24". One kit will handle gates up to 180 lb.

The EZ Gate is made of heavy duty steel with a black powder-coated finish to protect against corrosion and wear. It includes all necessary hardware for fast and simple installation.



- Trailer Tailgate Lift Assist
- Reduces lifting by 90%
- Reduces injuries and fatigue
- One kit works on gates up to 180 lbs.
- Simple installation
- No rattle spring insert
- Black powder coat finish
- Mounting hardware included
- Works on open utility trailers with siderail height of 10"-14"
- 71" x 2-1/2" diameter tube
- Retail friendly package size, 2-1/2" x 6" x 43-1/2"

Part No.	Description	Trailer Type	Wt. (lbs.)	Cat.
 5201000	EZ Gate™ Tailgate Lift Assist	Open	21.0	520 (N)

Torsion Ramp Spring



3002879



3034279

- 23 in.-lbs. per degree rating
- 3-3/4" wide
- 1.88" I.D.
- .468" dia. bar
- For HD trailer ramps

Part No.	Description	Wt. (lbs.)	Cat.
3002879	Left Hand Torsion Ramp Spring for Heavy-Duty Trailer Ramps	3.03	520 (N)
3002880	Right Hand Torsion Ramp Spring for Heavy-Duty Trailer Ramps	3.03	520 (N)
NEW 3034278	Left Hand Torsion Ramp Spring for Trailer Ramps - Replaces Sure-Trac ST9437L	0.63	520 (N)
NEW 3034279	Right Hand Torsion Ramp Spring for Trailer Ramps - Replaces Sure-Trac ST9437R	0.63	520 (N)

Ramp Hinge Bracket



- Stamped from 1/2" steel plate
- Other thicknesses and configurations are available by special order
- 4" L x 3" W
- 1.945" dia. hole
- Supports ramp spring mounting bars

Part No.	Description	Wt. (lbs.)	Cat.
RH4350	Ramp Hinge	1.16	512 (N)

Material Storage

Rubber Clamps



- **RC10S:**
 - Holds objects 1" to 2-1/2" in diameter (shovels, brooms, etc.)
 - Mounts with one #10 bolt and screws (not included)
 - Mounting base measures 2-3/4" L x 13/16" W
 - Each clamp supports approx. 22 lbs.
- **RC10L:**
 - Holds objects 2-1/2" to 9-1/2" in diameter (fire extinguishers, etc.)
 - Mounts with three #10 bolts or screws (not included)
 - Mounting base measures 6" x 7/8"
 - Each clamp supports a W.W.L. of 50 lbs.

Part No.	Description	Mounting Base	Mounting	S.W.L. (lbs.)	Wt. (lbs.)	Cat.
RC8M	Mini, Holds Objects 5/8" to 1-3/8" Diameter (i.e. Hand Tools)	1-3/4"L x 1-1/2"W	4 - #10 bolts/washers	25	0.12	520 (N)
RC10S	Small, Holds Objects 1" to 2-1/4" Diameter (i.e. Shovel)	2-1/2"L x 3/4"W	1 - #10 bolts/washers	25	0.30	520 (N)
RC10L	Large, Holds Objects 2-1/2" to 9-1/2" Diameter (i.e. Fire Extinguisher)	6"L x 7/8"W	3 - #10 bolts/washers	50	0.60	520 (N)

Diamond Tread Aluminum Chain Carrier



- Reinforced, structural steel construction
- Pre-drilled for simple frame mounting (bolts not included)
- Black powder coat finish
- TIG Welded
- Popular with over-the-road freight haulers required to carry tire chains

Part No.	Description	Height	Depth	Width	Wt. (lb)	Cat.
5910024	Hinged, Aluminum Diamond Plate Cover with Lock Hasp	9	7.5	24	34	591 (N)
3023908	Replacement Lid for 5910024 Chain Carrier				5.8	591 (N)

Traffic Cone Holders

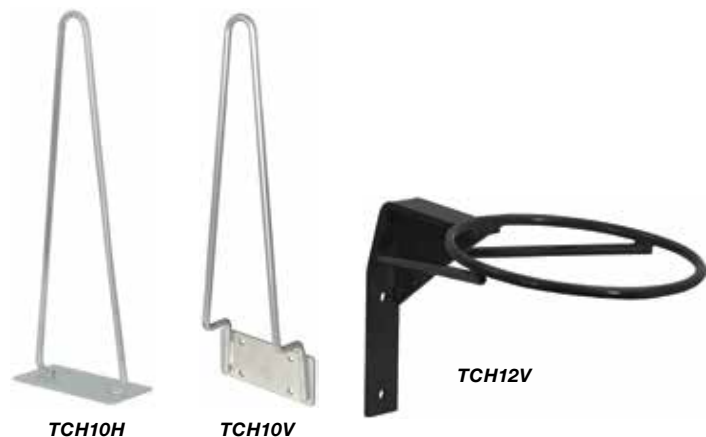

- Predrilled to mount to any flat surface (hardware not included)
- TCH10H and TCH10V packaged 2 per box

Part No.	Cones Held	Finish	Dimensions	Wt. (lb)	Cat.
TCH10V	(10) 18" or (5) 28"	Silver Powder-Coat (Zinc-Based)	22" Vertical Bracket Mount	2.5	520 (N)
TCH10H	(10) 18" or (5) 28"	Silver Powder-Coat (Zinc-Based)	18" Horizontal Bracket Mount	2.25	520 (N)
TCH12V	(10) 18"	Black Powder-Coat	12" Vertical Bracket Mount	8.41	520 (N)

Tank Holder for Vehicles



- 12-gauge zinc plated steel construction
- Wing nut & hinge design provide quick access
- Rubber gasket eliminates friction and noise

Part No.	Description	Wt. (lbs.)	Cat.
TH612714	Use for Oxygen & Acetylene Tanks (6-1/2" to 7-1/4" Dia.)	3	520 (N)
TH9934	Use for Oxygen Tanks (9" to 9-3/4" Dia.)	4	520 (N)

Water Cooler Mount



- Provides quick access mount for water coolers
- White powder coated steel
- Easy to install

Part No.	Description	Wt. (lbs.)	Cat.
 5201005	5 Gallon, White Mount	7.92	520 (N)

Spare Tire Carrier



- Universal Fit for 19.5" rims or smaller
- 14-gauge steel construction
- Oversized wing nut
- Bolt-on or weld-on
- Black powder coat finish

Part No.	Description	Wt. (lbs.)	Cat.
5201010	23-5/8"L x 6-1/2"W x 7/8"H	8	520 (N)

Stake Pocket Spare Tire Carrier



- Provides a removable spare tire mount on stake body trucks and trailers
- Fits wheels with the following bolt patterns: 5 on 4-1/2", 6 on 5-1/2", and 8 on 6-1/2"
- Fits most standard stake pockets
- Black powder coat finish
- Installation hardware included

Part No.	Description	Wt. (lbs.)	Cat.
 NEW 5201012	23-5/8"L x 6-1/2"W x 7/8"H	8	520 (N)

Stainless Steel Document Holder



- Ideal for tractor trailer applications
- Rubber caps provide tight seal
- 5-3/4" H x 2-13/16" W x 4" D stainless steel mounting bracket

Part No.	Description	Wt. (lbs.)	Cat.
5201100	1-5/8" Dia. x 9"	0.59	520 (N)

Document Holder With Clear Cover



- Corrosion, impact and UV-resistant plastic construction
- Keeps permits, work licenses, and other papers dry, secure and accessible
- Easy to use cover lets you see what's inside
- Interior spring keeps documents in place
- Mounting hardware included

Part No.	Description	Wt. (lbs.)	Cat.
 NEW 5201101	1-5/8" Dia. x 9"	0.40	520 (N)



Fenders

Smooth Poly Fender



- Injection molded poly construction won't rust or corrode
- Durable, forgiving, and lightweight poly construction
- Sold individually

Part No.	Description	Height	Depth	Width	Wt. (lbs.)	Cat.
8590195	Fits Minimum 19.5" Dual Rear Wheels	20"	22-1/2"	48"	8.5	859 (N)

*Compares to: *Minimizer® PM1901; Fleet Engineer's Inc.® 034-02130*

Ribbed Poly Fender



- Integrated molded ribs add strength and reduce spray
- Injection molded poly construction won't rust or corrode
- Durable, forgiving, and lightweight poly construction
- Sold Individually

Part No.	Description	Height	Depth	Width	Wt. (lbs.)	Cat.
8590245	Fits Up to 24.5" Dual Rear Wheels	23-1/2"	26-1/2"	50-1/2"	14.3	859 (N)

*Compares to: *Minimizer® PM2201 & PM2401; Fleet Engineer's Inc.® Spray Mate® 034-01520*

Tri-axle Fender



8591040



8591050



8591060

- Fit Wheel Sizes: 22.5", 24.5" and 25.0"

Part No.	Description	Height	Depth	Width	Wt. (lbs.)	Cat.
8591040	Poly Pusher Fender (Front)	19.69"	17.32"	52.95"	7	859 (N)
8591050	Poly Intermediate Fender (Middle)	10.63"	27"	56.38"	10	859 (N)
8591060	Poly Intermediate Fender (Rear)	19.69"	27"	55.45"	11	859 (N)

Full Radius Poly Fender

- Integrated molded ribs add strength and reduce spray
- Injection molded poly construction won't rust or corrode
- Durable, forgiving, and lightweight poly construction
- Sold Individually



Part No.	Description	Height	Depth	Width	Wt. (lbs.)	Cat.
8590017	To Fit 16-1/2 Inch Dual Wheels	14.875"	19.375"	37"	8.6	859 (N)
8590196	To Fit 18 To 19-1/2 Inch Dual Wheels	17.625"	20"	39"	8	859 (N)

*Buyers Products is not authorized by nor affiliated with the manufacturer of *Spray Control Systems, Inc.®* or *Fleet Engineer's Inc.®* products.

Wide Rubber Fender Extension



- 1/4" thick
- Extends fender 2-1/2"
- Built-in curvature for smooth fit
- Supplied in 50' coils

Part No.	Description	Wt. (lbs.)	Cat.
B52150	Black Rubber Fender Extension	30	874 (N)

Blind Mount Rubber Fender Extension



- 3/16" thick
- Extends fender 2"
- Built-in curvature for smooth fit
- Supplied in 50' coils

Part No.	Description	Wt. (lbs.)	Cat.
B52169	Black Rubber Fender Extension	28	874 (N)

Replacement Parts

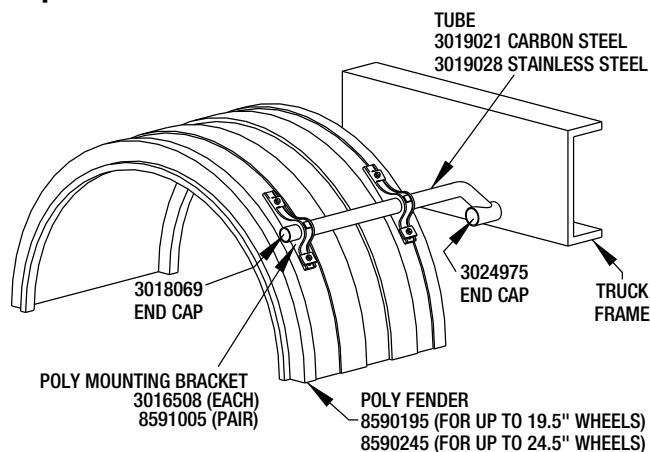

Part No.	Description	Wt. (lbs.)	Cat.
3018069	Black Plastic End Cap	0.02	859 (N)
3024975	Black Plastic End Cap (Frame End)	0.02	859 (N)
NEW 3035509	Black Plastic End Cap	0.02	859 (N)

Fender Mounting Arm



- 1 - Fender Mounting Arm
- 1 - Bolt

Part No.	Description	Wt. (lbs.)	Cat.
8591010	Black Powder Coated	8.05	859 (N)

Straight Fender Mounting Kit



- Flush, End-mount Design
- Black Powder Coat or Stainless Steel
- 30.25" Long x 1.88" Diameter x .125" Wall Straight Tubing
- Kit Includes: (2) Straight Mounting Tubes, (2) Plastic End-caps & Fasteners
- 2 pair of 8591005 required per fender (sold separately)

Part No.	Description	Wt. (lbs.)	Cat.
8591020	Black Powder Coated	13	859 (N)

*Compares to: Fleet Engineer's Inc.® 031-01250 & 031-1251

Fender Hanger Bracket



Part No.	Description	Wt. (lbs.)	Cat.
8591005	A Pair	2.4	859 (N)
3016508	One	1.2	859 (N)

Poly Fender Mounting Kit



- Heavy wall, structural steel
 - Black powder coat or stainless steel
 - 30.5" long mounts covers all dual rear wheel applications
 - 5" tubing offset clears spring shackles and adjusts fender mounting height
 - Kit includes: (2) steel or stainless steel tube mounting brackets with end caps, (2) frame bolts, (4) poly fender hanger brackets with fasteners
 - For use with 8590195, 8590245, 8590017, 8590196
- Note: Order (1) kit for one fender. Order (2) kits for two rear fenders.**

Part No.	Description	Wt. (lbs.)	Cat.
8591000	Black Powder Coated	24	859 (N)
8591001	Stainless Steel	24	859 (N)

*Compares to: Spray Mate® 031-00883 mounts with 031-00823 hangers



Mudflaps

"Caution Wide Turns" Polymer Mudflaps



- 3/16" super durable polymer mudflaps
- Withstands impact & stress while maintaining appearance & anti-sail properties
- Withstands subfreezing temps
- Resists buildup of ice & snow
- Repels impact from road debris
- Bright yellow & "Caution Wide Turns" increase safety

Part No.	Color	Size (W x L)	Wt./Pair (lbs.)	Cat.
B2424YC	Yellow	24" x 24"	7	842 (Y)
B2430YC	Yellow	24" x 30"	8	842 (Y)
B2436YC	Yellow	24" x 36"	10	842 (Y)

Spray Reducing Grooved Polymer Mudflaps



- 5/16" thick polymer mudflaps
- Heavy duty, no sail design
- Unique design minimizes spray
- Withstands subfreezing temps
- Resists buildup of ice & snow
- Repels impact from road debris
- Stocked in white & black
- Custom sizes and colors quoted on request
- 40+ gloss pigment foils are stocked & available for custom imprinting
- As large as 20" x 20" area available for custom imprinting

Part No.	Color	Size (W x L)	Wt./Pair (lbs.)	Cat.
B24PSRPB	Black	24" x 24"	11	833 (Y)
B24PSRPW	White	24" x 24"	11	833 (Y)
B30PSRPB	Black	24" x 30"	14	833 (Y)
B30PSRPW	White	24" x 30"	14	833 (Y)
B36PSRPB	Black	24" x 36"	17	833 (Y)
B36PSRPW	White	24" x 36"	17	833 (Y)

Thermo Flex Fender Guard Mudflaps



- 1/8" thick poly mudflaps
- Add style to your truck or trailer
- Repels impact from road debris
- Withstands subfreezing temps.
- Resists buildup of ice & snow
- 40+ gloss pigment foils are stocked & available for custom imprinting

Part No.	Color	Size (W x L)	Wt./Pair (lbs.)	Cat.
B915PPB	Black	9" x 15"	1	840 (Y)
B1018PPB	Black	10" x 18"	1	840 (Y)
B1020PPB	Black	10" x 20"	1	840 (Y)
B117518PPB	Black	11.75" x 17.75"	2	840 (Y)
B1237PPB	Black	12" x 37"	3	840 (Y)
B1237PPW	White	12" x 37"	3	840 (Y)

Polymer Mudflaps



- 3/16" super durable polymer mudflaps
- Withstands subfreezing temps
- Resists buildup of ice & snow
- Repels impact from road debris
- Stocked in white, black, red, blue, and yellow
- 40+ gloss pigment foils are stocked & available for custom imprinting
- As large as 20" x 20" area available for custom imprinting
- Custom sizes and colors quoted on request

Part No.	Color	Size (W x L)	Wt./Pair (lbs.)	Cat.
RC18PPB	Black	24" x 18"	5	850 (Y)
RC18PPW	White	24" x 18"	5	850 (Y)
RC24PPB	Black	24" x 24"	7	850 (Y)
RC24PPW	White	24" x 24"	7	850 (Y)
B24PPY	Yellow	24" x 24"	7	850 (Y)
RC30PPB	Black	24" x 30"	8	850 (Y)
RC30PPBLU	Blue	24" x 30"	8	850 (Y)
RC30PPR	Red	24" x 30"	8	850 (Y)
RC30PPW	White	24" x 30"	8	850 (Y)
B30PPY	Yellow	24" x 30"	8	850 (Y)
RC36PPB	Black	24" x 36"	10	850 (Y)
RC36PPW	White	24" x 36"	10	850 (Y)
B36PPY	Yellow	24" x 36"	10	850 (Y)
RC40PPB	Black	24" x 40"	12	850 (Y)
RC40PPW	White	24" x 40"	12	850 (Y)

Composite Mudflaps

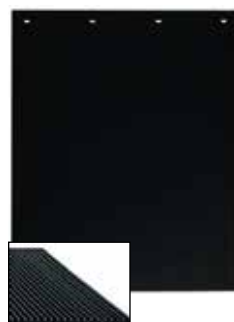

- Available with 1/4" or 3/8" grooves on back
- Heavy duty, no sail design
- Withstands subfreezing temps
- Custom sizes quoted on request
- 40+ gloss pigment foils are stocked & available for custom imprinting
- As large as 20" x 20" area available for custom imprinting

Part No.	Color	Size (W x L)	Wt./Pair (lbs.)	Cat.
BSGS2018	Black	20" x 18" x 1/4"	5	845 (Y)
BSGS2030	Black	20" x 30" x 1/4"	11	845 (Y)
BSGS2424	Black	24" x 24" x 1/4"	9	845 (Y)
BSGS2430	Black	24" x 30" x 1/4"	12	845 (Y)
BSGS2436	Black	24" x 36" x 1/4"	15	845 (Y)
BSGD2424	Black	24" x 24" x 3/8"	11	845 (Y)
BSGD2430	Black	24" x 30" x 3/8"	14	845 (Y)
BSGD2436	Black	24" x 36" x 3/8"	17	845 (Y)

Heavy Anti-Spray Rubber Mudflaps



- 1/2" thick rubber mudflaps
- Repels spray with special 1/4" broad based knobs
- Resists impact, cutting & tearing
- Resists buildup of ice & snow
- Repels impact from road debris

Part No.	Color	Size (W x L)	Wt./Pair (lbs.)	Cat.
B24SRP	Black	24" x 24"	19	800 (Y)
B30SRP	Black	24" x 30"	22	800 (Y)
B36SRP	Black	24" x 36"	24	800 (Y)

Solid Rubber Mudflaps



- 1/2" thick rubber mudflap
- Solid back
- For use in off-road conditions
- Resists impact, cutting & tearing
- Resists buildup of ice & snow
- Repels impact from road debris

Part No.	Color	Size (W x L)	Wt./Pair (lbs.)	Cat.
B24SPP	Black	24" x 24"	21	820 (Y)
B30SPP	Black	24" x 30"	27	820 (Y)
B36SPP	Black	24" x 36"	33	820 (Y)

Heavy-Duty Rubber Mudflaps



- 1/4" thick rubber mudflaps
- Resists impact, cutting & tearing
- Resists buildup of ice & snow
- Repels impact from road debris

Part No.	Color	Size (W x L)	Wt./Pair (lbs.)	Cat.
B1018LSP*	Black	10" x 18"	3	780 (N)
B1218LSP	Black	12" x 18"	4	780 (N)
B1412LSP	Black	14" x 12"	4	780 (N)
B1812LSP	Black	18" x 12"	4	780 (N)
B1820LSP	Black	18" x 20"	7	780 (N)
B2014LSP	Black	20" x 14"	6	780 (N)
B2018LSP	Black	20" x 18"	7	780 (N)
B2020LSP	Black	20" x 20"	8	780 (N)
B2024LSP	Black	20" x 24"	9	780 (N)
B2030LSP	Black	20" x 30"	13	780 (N)
B2412LSP	Black	24" x 12"	7	780 (N)
B2414LSP	Black	24" x 14"	7	780 (N)
B2418LSP	Black	24" x 18"	8	780 (N)
B2420LSP	Black	24" x 20"	9	780 (N)
B24LP	Black	24" x 24"	12	780 (N)
B30LP	Black	24" x 30"	14	780 (N)
B36LP	Black	24" x 36"	16	780 (N)
B40LP	Black	24" x 40"	18	780 (N)

*Teardrop Style

Super Heavy-Duty Rubber Mudflaps



- 3/8" thick rubber mudflaps
- Resists impact, cutting & tearing
- Resists buildup of ice & snow
- Repels impact from road debris

Part No.	Color	Size (W x L)	Wt./Pair (lbs.)	Cat.
B24LXP	Black	24" x 24"	16	810 (Y)
B30LXP	Black	24" x 30"	18	810 (Y)
B36LXP	Black	24" x 36"	20	810 (Y)
B40LXP	Black	24" x 40"	22	810 (Y)



Boomerang
RUBBER, INC.

www.BoomerangRubber.com

Need Custom Printed Rubber Flaps?



Boomerang Rubber, part of the Buyers family of manufacturing companies, manufactures high quality, long-lasting, heavy duty mud flaps, made from 100% post production recycled material.

Boomerang Rubber is ISO 14001:2015 certified.

Call (937) 693-4611 for a quote
50 Piece Minimum

Black is the NEW Green  Made in the U.S.A.



Products are Retail Packaged



Splash Guards & Accessories

Mudflap Bolting Plate



- Reinforces the critical bolt hole area of all 24" wide rubber or plastic splash guards
- Black powder coat finish
- Sold in pairs
- 25 Pairs per master carton

Part No.	Description	Wt./Pair (lbs.)	Cat.
MFW2375	Black Powder Coated Steel	2.6	859 (N)

Mudflap Mounting Plate



- Welds to truck or trailer body to provide fast & economical mount for all 24" wide splash guards
- Sold in pairs

Part No.	Description	Wt./Pair (lbs.)	Cat.
MFBH2375F	Straight Mounting Plate	6.5	859 (N)

90° Mudflap Mounting Plate



- Welds to truck or trailer body to provide fast & economical mount for all 24" wide splash guards
- Sold in pairs

Part No.	Description	Wt./Pair (lbs.)	Cat.
MFBH2375A	90° Mounting Plate	6.5	859 (N)

Anti-Sail Brackets for Mudflaps

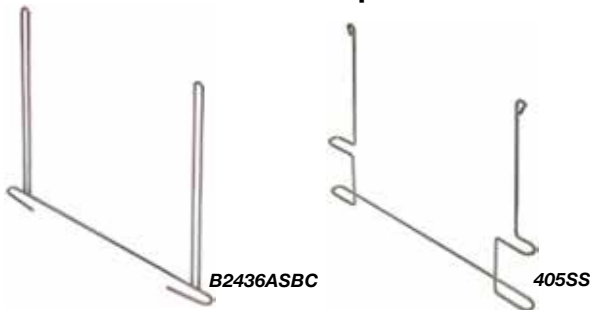

- Bolts-on or welds to truck or trailer body to provide fast & economical mount for all 24" wide splash guards
- Sold in pairs and Bulk per Case

Part No.	Description	Number of Pairs in Case	Height	Width	Wt./Pair (lbs.)	Cat.
400BZ	Galvanized, Sized For Exhaust Tip Clearance	5	20-3/4	21-3/8	4.1	859 (N)
NEW 400SS	Stainless Steel, Sized For Exhaust Tip Clearance	5	20-3/4	21-3/8	4.1	859 (N)
405BZ	Galvanized	5	21	26-1/8	4.45	859 (N)
405BC	Chrome Plated	5	21	26-1/8	4.45	859 (N)
405SS	Stainless Steel, Sized For Exhaust Tip Clearance	5	20-3/4	21-3/8	4.1	859 (N)
B2436ASBC	Chrome Plated (5 Pairs Per Case)	5	20-3/4	24-1/2	5.7	859 (N)
B2418ASBC	Chrome Plated (5 Pairs Per Case)	5	9	24-1/2	5.2	859 (N)
NEW 3037722	Black Powder Coated, Sized For Exhaust Tip Clearance	5	20-3/4	21-3/8	4.1	859 (N)

Steel Splash Guard



- Includes: (2) splash shields, (2) tubes, (2) end cap plugs
- 2" steel tube welds to hoist sub-frame in front of the rear wheels on dump bodies
- Requires no additional bracing
- Predrilled holes for easy installation (fasteners not included)
- Guards bolt on to mounting tubes
- Black powder coat finish

Part No.	Description	Size	Wt./Pair (lbs.)	Cat.
SG2228	Heavy-Duty, 12 Gauge Reinforced Steel Guards	22" x 28"	51	859 (N)

Aluminum Splash Guard

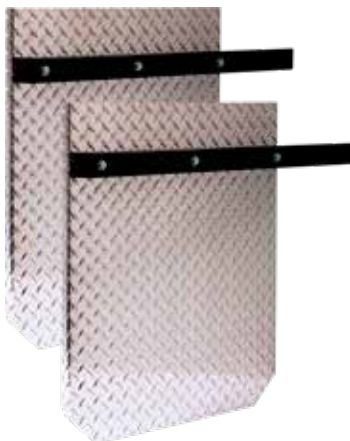

- Includes: (2) splash shields, (2) mounting tubes, (2) end cap plugs
- 2" steel tube welds to hoist sub-frame in front of the rear wheels on dump bodies or flatbeds
- Requires no additional bracing
- Predrilled holes for easy installation (fasteners not included)
- Guards bolt on to mounting tubes

Part No.	Description	Size	Wt./Pair (lbs.)	Cat.
SG2229	.100" Thick Aluminum Diamond Tread Guards	22" x 28"	29	859 (N)

Aluminum Stone Guard



- Protects lower front panel of utility bodies & underbody toolboxes from stone chips & road debris
- Six predrilled 3/16" mounting holes
- Includes 12 rivets

Part No.	Description	Size	Wt.(lbs.)	Cat.
STG1210	.100" Thick Aluminum Diamond Tread Guard	10" x 12"	1.4	859 (N)



Plow / Bumper Guides

Fluorescent Orange Bumper Guides

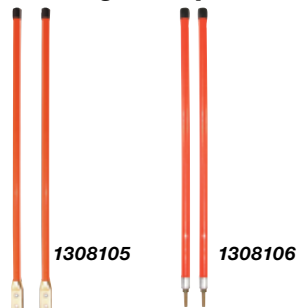

- 3/4" O.D. tube is constructed of low temperature fluorescent orange nylon
- Full 1/8" wall size
- More surface area than conventional markers
- Sold in pairs with vertical mounting fasteners included
- Horizontal mounting brackets are available

Part No.	Dimensions	Mount	Wt. (lbs.)	Cat.
1308105	3/4" x 28"	Bolt-On Base	0.80	900 (N)
1308107	3/4" x 28"	Bolt-On Base	0.68	900 (N)
1308110	3/4" x 36"	Bolt-On Base	1.00	900 (N)
1308115	3/4" x 48"	Bolt-On Base	1.06	900 (N)
1308103	3/4" x 24"	Stud Mount	0.68	900 (N)
1308106	3/4" x 28"	Stud Mount	0.72	900 (N)
1308111	3/4" x 36"	Stud Mount	0.98	900 (N)
1308125	Horizontal Adapter Kit		0.36	900 (N)

Oversized Bumper Sight Guides

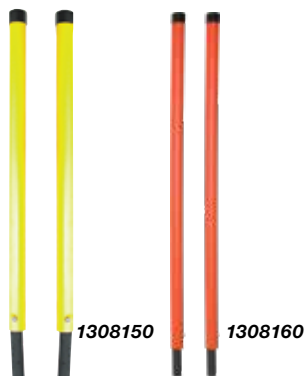

- Oversized
- High density orange or yellow poly guides
- Black nylon caps
- Flexible base
- Comes in pairs

Part No.	Description	Wt. (lbs.)	Cat.
1308150	1-5/16" x 24" Oversized (pair), Yellow	1.50	900 (N)
1308160	1-5/16" x 36" Oversized (pair), Orange	1.85	900 (N)

Illuminated LED Guides



- Patented light-up design makes it easier to see your equipment in low visibility conditions
- Includes wiring harness that is 12 ft per side with a pre-terminated male bullet connector and ring terminal to connect to the LED guides
- Unique, eye-catching look helps your truck stand out from the competition
- Easy wiring and installation that only requires a few basic tools
- Compatible with most snow plows and truck bumpers

Part No.	Description	Wt. (lbs.)	Cat.
1308124	24 Inch Illuminated LED Snow Plow Blade Guides	2.18	520 (N)
1308128	28 Inch Illuminated LED Snow Plow Blade Guides	2.22	520 (N)
1308136	36 Inch Illuminated LED Snow Plow Blade Guides	2.48	520 (N)
1308126	Horizontal Adapter Kit for 1/2" Base with Hardware	0.58	900 (N)

Bulk Storage Tanks

Construction

Produced out of all-virgin, medium-density polyethylene with ultraviolet (UV) inhibiting stabilizers, allowing for long-term outdoor storage. The all-purpose bulk storage tanks are designed for convenient dispensing and storage of chemicals (not to exceed specific gravity of 1.7, excluding flammable hydrocarbons).

Approved for:

- Potable Water
- Agricultural Chemicals
- Industrial Chemicals
- Other Non-Flammable Liquids

Tanks not intended for fuel storage

Environmental

The recommended maximum contact operating temperature is 110°F.

Features & Benefits

- Large fill cap & drain
- 3/4" bulkhead fitting, (2" on 325 & 550 gallon tanks)
- One piece molded tank
- Molded-In channels for saddle straps
- Thick walled, heavy-duty construction
- Low-profile design
- Translucent material for easy visibility of fluids
- Molded in graduation marks (in gallons & liters)
- Easy-tighten cap

Domed Storage Tanks



Part No.	Description	Capacity	Dimensions (LxWxH)	Wt. (lbs.)	Cat.
82123879*	Domed Storage Tank	8 Gal.	16" x 12" x 15"	7 lbs.	653 (Y)
82123889*	Domed Storage Tank	16 Gal.	22" x 16" x 16"	10 lbs.	653 (Y)
82123899*	Domed Storage Tank	26 Gal.	26" x 18" x 19"	12 lbs.	653 (Y)

* Can be shipped UPS

Square End Storage Tanks



Part No.	Description	Capacity	Dimensions (LxWxH)	Wt. (lbs.)	Cat.
82123909*	Square End Storage Tank	30 Gal.	24" x 19" x 22"	18 lbs.	653 (Y)
82123919*	Square End Storage Tank	50 Gal.	38" x 19" x 22"	25 lbs.	653 (Y)
82123929	Square End Storage Tank	100 Gal.	38" x 30" x 29"	40 lbs.	653 (Y)

* Can be shipped UPS



Bulk Storage Tanks

Storage Tanks with Legs



Part No.	Description	Capacity	Dimensions (LxWxH)	Wt. (lbs.)	Cat.
82123939	Storage Tank with Legs	65 Gal.	38" x 23" x 27"	28 lbs.	653 (Y)
82123949	Storage Tank with Legs	125 Gal.	48" x 36" x 28"	50 lbs.	653 (Y)
82124269	Storage Tank with Legs	550 Gal.	78" x 48" x 49"	160 lbs.	653 (Y)

Pick-Up Truck Storage Tanks



Part No.	Description	Capacity	Dimensions (LxWxH)	Wt. (lbs.)	Cat.
82124639	Pick-Up Truck Storage Tank	210 Gal.	60" x 52.5" x 29.75"	90 lbs.	653 (Y)
82124649	Pick-Up Truck Storage Tank	325 Gal.	62" x 52.5" x 32.75"	110 lbs.	653 (Y)

Vertical Storage Tanks



Part No.	Description	Capacity	Dimensions (LxWxH)	Wt. (lbs.)	Cat.
82124749	Vertical Storage Tank	550 Gal.	67" x 45"	140 lbs.	653 (Y)
82124659	Vertical Storage Tank	1,550 Gal.	86" x 71"	315 lbs.	653 (Y)

Hardwood Outrigger Pad

- Constructed of natural hardwood in a "floating design" to avoid cracking and breaking
- Heavy duty U-bolt style handle runs the complete length of the pad for improved strength
- Handle is generously sized for gloved hands



Part No.	Description	Wt. (lbs.)	Cat.
OP18X18	Hardwood Outrigger Pad, 18" x 18" x 2"	18.0	520 (N)

Rubber Outrigger Pad

- Constructed of 2" solid rubber
- Textured surface
- Built-in handle
- Ideal for concrete, paved surfaces, and off road use



Part No.	Description	Wt. (lbs.)	Cat.
OP18X18R	Rubber Outrigger Pad, 18" x 18" x 2"	34.5	520 (N)
NEW OP24X24R	Rubber Outrigger Pad, 24" x 24" x 2"	52.8	520 (N)

HDPE Poly Outrigger Pad

- Durable, HDPE High Density Polyethylene Construction
- 1/2 the weight of rubber
- Compact
- Rope style handle



Part No.	Description	Wt. (lbs.)	Cat.
NEW OP12X12P	Poly Outrigger Pad, 12" x 12" x 1"	5	520 (N)
NEW OP15X15P	Poly Outrigger Pad, 15" x 15" x 1"	7.5	520 (N)
OP18X18P	Poly Outrigger Pad, 18" x 18" x 1"	11.7	520 (N)
OP181815	Poly Outrigger Pad, 18" x 18" x 1.5"	17.5	520 (N)
OP24X24P	Poly Outrigger Pad, 24" x 24" x 1"	20.8	520 (N)
OP242415	Poly Outrigger Pad, 24" x 24" x 1.5"	30	520 (N)

UHMW Poly Outrigger Pad

- Ultra durable UHMW polyethylene, construction is a lightweight alternative to rubber
- Ideal for protecting concrete, paved, and other surfaces
- Textured surface
- Built-in rope handle for easy transport



Part No.	Description	Wt. (lbs.)	Cat.
OP181810	Poly Outrigger Pad, 18" x 18" x 1"	11.22	520 (N)
NEW OP242410	Poly Outrigger Pad, 24" x 24" x 1"	19	520 (N)
OP242420	Poly Outrigger Pad, 24" x 24" x 1"	40.1	520 (N)



Wheel Chocks

Heavy-Duty Rubber Chock with Chain Eye



- Reinforced rubber design
- Includes chain eye
- WC6810L is patent pending

Part No.	Description	Height	Depth	Width	Wt. (lbs.)	Cat.
WC1086	Rubber Wheel Chock with Chain Eye	6"	8"	10"	8.25	380 (N)
WC6810L	Rubber Wheel Chock with Chain Eye Recessed	6"	8"	10"	7.46	380 (N)

Heavy-Duty Rubber Chock with Handle



- Reinforced rubber design
- Includes handle

Part No.	Description	Height	Depth	Width	Wt. (lbs.)	Cat.
WC1085H	Rubber Wheel Chock with Handle	5"	8"	10"	8.2	380 (N)

Heavy-Duty Rubber Chock with Molded Hand Hold

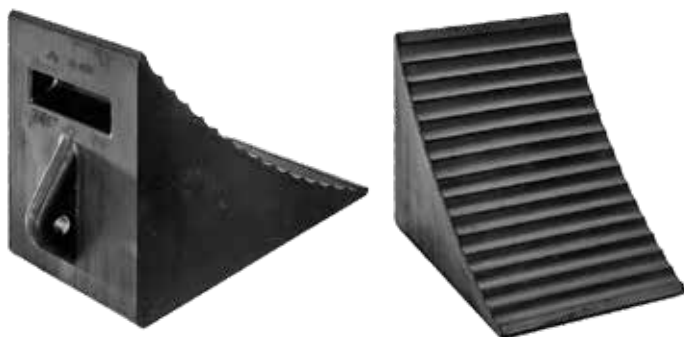

- Designed for unusually heavy loads
- Built to OSHA standards
- Convenient molded handhold and chain eye

Part No.	Description	Height	Depth	Width	Wt. (lbs.)	Cat.
WC2556A	Rubber Wheel Chock with Handle & Chain Eye Molded In	8.13"	10.25"	7"	9.95	380 (N)

Laminated Rubber Wheel Chock

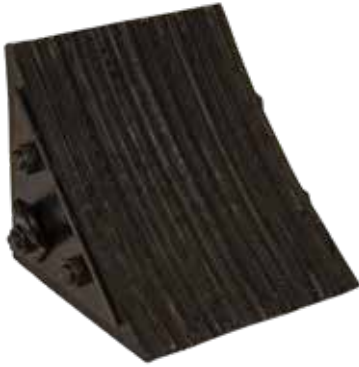

- Features durable, recycled tire rubber pressed between two 1/4" steel plates
- Includes retaining bracket for use with chains

Part No.	Description	Height	Depth	Width	Wt. (lbs.)	Cat.
WC0888	Rubber Wheel Chock with Retaining Bracket for Chains	8"	8"	8.75"	15	380 (N)

Heavy-Duty Rubber Chock U-Handle



- Reinforced rubber design
- Perfect for most applications
- Includes "U" wire handle

Part No.	Description	Height	Depth	Width	Wt. (lbs.)	Cat.
WC1086UWH	Rubber Wheel Chock with Handle	5.88"	7.5"	9.63"	9.1	380 (N)

Customized Heavy-Duty Rubber Chock

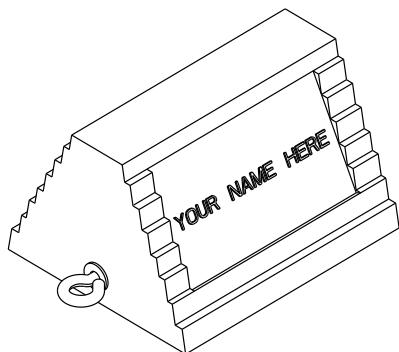

- For part number WC1086
- 500 piece minimum order
- Customizable area is 4" x 7"
- Call customer service at (440) 974-8888 for a quote



Wheel Chocks

Rubber Wheel Chock



WC1467A

WC1468A

- Reinforced rubber design
- Resistant to sun, salt, oil and acid

Part No.	Description	Height	Depth	Width	Wt. (lbs.)	Cat.
WC1467A	Rubber Wheel Chock	5"	6"	5"	2.78	380 (N)
WC1468A	Rubber Wheel Chock	5"	6"	8"	4.4	380 (N)

Rubber Wheel Chock with Chain Eye



- Reinforced rubber design
- Resistant to sun, salt, oil and acid
- Includes chain eye

Part No.	Description	Height	Depth	Width	Wt. (lbs.)	Cat.
WC796R	Rubber Wheel Chock with Chain Eye	7"	7"	9-1/2"	9.69	380 (N)

Rubber Wheel Chock Set



- Ribbed extruded rubber chock for aircraft, ground equipment or for anchoring large pipe
- 3 ft. Nylon rope
- High visibility reflective tape on three sides

Part No.	Description	Height	Depth	Width	Wt. (lbs.)	Cat.
WC24483	Rubber Wheel Chocks with Rope	4"	4"	8"	6	380 (N)

Mini Rubber Wheel Chock Set



- For ATVs & similar type vehicles
- Not for automotive or truck use
- 36" Rope

Part No.	Description	Height	Depth	Width	Wt. (lbs.)	Cat.
 WC35225	Mini Rubber Wheel Chocks with Rope	2.25"	5"	3"	1.67	380 (N)

Composite Wheel Chock Set





- 100% recycled composite, safety yellow
- Resistant to oils & chemicals
- Will not deteriorate or rot
- 32-3/4" rope, boxed in sets

Part No.	Description	Height	Depth	Width	Wt. (lbs.)	Cat.
WC9642Y	Composite Wheel Chocks with Rope	4"	6"	9.5"	10.5	380 (N)

Orange Polyurethane Wheel Chock Set



- Semi-rigid polyurethane
- Fluorescent orange for high visibility
- 1/2 the weight of rubber
- Built-in carrying hand grip
- Includes mounting holes for rope, eye bolts, etc.
- Two wheel chocks per box

Part No.	Description	Height	Depth	Width	Wt. (lbs.)	Cat.
 WC786	Orange Polyurethane Wheel Chock Set, Small	6.25"	8.31"	7.38"	2.37	380 (N)
 WC8118	Orange Polyurethane Wheel Chock Set, Large	8.13"	11.25"	8.69"	2.37	380 (N)

Black Polyurethane Wheel Chock



- 100% Recycled plastic (solid)
- 3/4" Zinc plated handle
- 1/8" Aluminum grating base for snow, ice, and mud

Part No.	Description	Height	Depth	Width	Wt. (lbs.)	Cat.
WC8127	Black Polyurethane Wheel Chock Set with Grating Base	8"	12"	7"	9.7	380 (N)



Wheel Chocks

Aluminum Chock

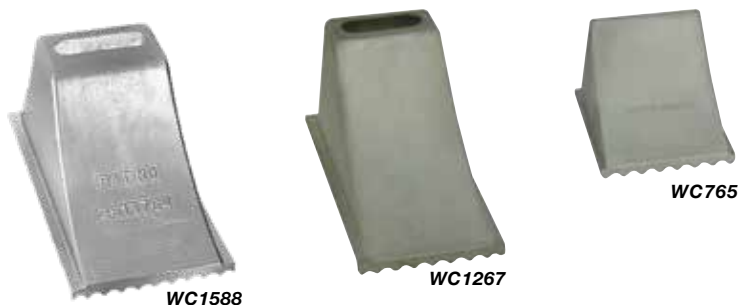

- Light weight
- Reduces operator fatigue

Part No.	Description	Height	Depth	Width	Capacity (lbs.)	Wt. (lbs.)	Cat.
WC765	Aluminum Wheel Chock, Small	5-1/4"	7"	6"	28,000	1.5	380 (N)
WC1267	Aluminum Wheel Chock, Medium	7"	12-1/4"	6-1/4"	55,000	3.25	380 (N)
WC1588	Aluminum Wheel Chock, Large	8-1/4"	15"	8-1/2"	70,000	7.25	380 (N)

Wheel Chock Bracket



- Safely store WC1267 wheel chocks
- Mounts easily to trailer bed, fender or loading dock
- 1/4" x 1-1/4" steel bar
- Black powder coat finish

Part No.	Description	Wt. (lbs.)	Cat.
WCB186	Black Powder Coated Steel Bar	4.86	380 (N)

Aluminum Wheel Chock with Ribbed Slope

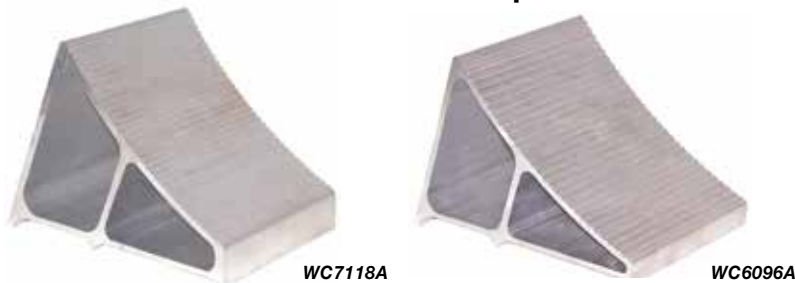

- Extruded aluminum
- Great for ice and snow conditions
- For use in chocking semi-trailers and trucks

Part No.	Description	Height	Depth	Width	Wt. (lbs.)	Cat.
WC6096A	Extruded Aluminum Wheel Chock, Small	5.86"	8.75"	6"	3.54	380 (N)
WC7118A	Extruded Aluminum Wheel Chock, Large	7.8"	10.75"	7"	7.3	380 (N)

Galvanized Serrated Wheel Chock



- Great for off-road ice and snow conditions
- Serrated texture on all sides offers extra "grip"
- Built-in grab handle

Part No.	Description	Height	Depth	Width	Wt. (lbs.)	Cat.
WC091060	Galvanized Serrated Wheel Chock with Handle	6"	10"	9"	10	380 (N)
WC091061	Orange Powder Coated Galvanized Steel Wheel Chock with Handle	6"	10"	9"	10	380 (N)

Chrome Plated Steel Motorcycle Chock



- Fits tires up to 5-1/2" wide
- Quick mount design interlocks with floor mounted receivers
- Durable, 3/4" chrome plated steel tubing construction with welded braces
- Chrome finish

3801000

Part No.	Description	Height	Depth	Width	Wt. (lbs.)	Cat.
 WC100609	Chrome Plated Steel Wheel Chock with Hardware	9"	10"	5-1/2"	4.5	380 (N)
 3801000	Extra Mounting Hardware Kit for WC100609*	-	-	-	0.92	380 (N)

*Additional mounting hardware available for alternative mounting/storage solutions

Black Powder Coated Steel Motorcycle Wheel Chock

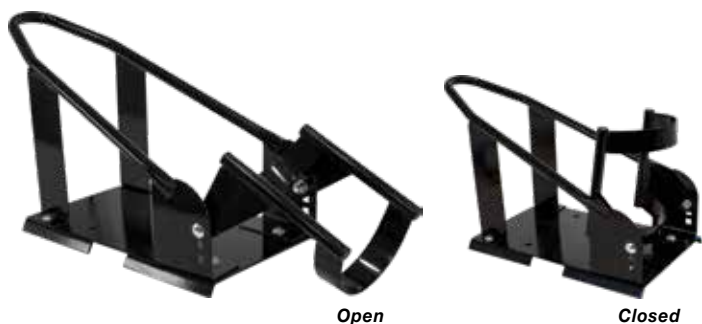

Open

Closed

- Fits 17" to 21" wheels with tires up to 5-1/2" wide
- Mounts firmly to truck beds, trailers, and garage floors
- Drive-in wheel lock makes securing your vehicle quick and easy
- Ideal solution for storing or transporting your motorcycle or moped
- Black powder coat finish

Part No.	Description	Height	Depth	Width	Wt. (lbs.)	Cat.
 WC151013	Black Powder-Coated Steel Motorcycle Wheel Chock	13.13"	28"	10.5"	13.2	380 (N)

Carbon Steel Motorcycle Chock



- Tapered design fits tires up to 5-1/2" wide
- Bolt-down design for truck beds, trailers or garage floors
- Solid carbon steel construction, 3/16" mounts & 5/8" formed rod
- Durable black powder coat finish

Part No.	Description	Height	Depth	Width	Wt. (lbs.)	Cat.
 WC181212	Black Powder Coated Steel Wheel Chock with Hardware	12-1/4"	18"	12"	9.65	380 (N)



Work Wear

Multi-Use Commercial Work Gloves



- Durable, synthetic leather palm
- Comfortable, form fitting back
- Vented fingers for breathability
- Adjustable wrist closure for optimum fit
- Retail cut case box included with 9901000

Part No.	Description	Wt. (lbs.)	Cat.
9901000	Case Pack Black Work Gloves. Includes: 10-Pair X-Large and 10-Pair XX-Large	5.60	990 (N)
9901005	Large Black Work Gloves	0.23	990 (N)
9901010	X-Large Black Work Gloves	0.24	990 (N)
9901015	XX-Large Black Work Gloves	0.24	990 (N)

Buyers Products Black Knit Hat



- One size fits all
- Embroidered Buyers Products Logo

Part No.	Description	Wt. (lbs.)	Cat.
9901100	Black Knit Hat	0.13	903-1 (N)

TARP SYSTEMS

We've built a full line of electric and manual tarps as well as replacement parts for every application.

ELECTRIC TARP SYSTEMS	F3
NEW Steel Electric Tarp Systems	F3
ELECTRIC TARP SYSTEM PARTS AND ACCESSORIES	F4
NEW High Torque Tarp Gear Motor	F4
NEW Aluminum Tension Bow	F5
NEW Tarp Arm Accessories	F6
NEW Electrical Parts and Accessories	F7
MANUAL TARP SYSTEMS	F8
NEW Tapered Cab Shield DTR Mounting Brackets	F8
NEW Retention Bow Catch Plate	F9
NEW Aluminum Chain Guard	F10
NEW Manual Tarp Systems with Aluminum Deflector and Housing	F11
TARPS	F12
MANUAL TARP SYSTEM PARTS	F13



Electric Tarp Systems

Electric Arm Tarp Systems

Choose the following options:

PIVOTS

Side mount pivots (4- or 5-spring)
with die-cast aluminum housing

OR

Underbody pivots (tension springs)

ARMS

Telescoping extruded aluminum arms

OR

Telescoping steel arms

AND

Each System Includes



60:1 or 90:1 gear motors
available with 1 or 3 year
warranty.



60A, auto-reset circuit breaker



60', 8 Ga dual conductor
battery cable



Rocker switch and solenoid
with cover



Wind deflector

Tarps Are Sold Separately See Page F12



60:1 or 90:1 High torque
tarp gear motor with cover

(6) Poly arm guides

One-piece aluminum wind deflector

Universal side mount pivots
with die cast housing
4-spring (Fits 8'-19' Dumps)
5-spring (Fits 14'-23' Dumps)

Telescoping pivot arm assembly
4-spring (Fits 8'-19' Dumps)
5-spring (Fits 14'-23' Dumps)



now available in steel arms

5544000

Part No.	Material	Springs	Wind Deflector	Gear Motor	Motor Warranty	Wt. (lbs.)	Cat.
Fits 8' - 19' Dumps							
5544000	Aluminum	4-Spring Steel	Yes	600W / 90:1	1 Yr.	126	554-2 (N)
5544300	Aluminum	4-Spring Steel	Yes	600W / 90:1	3 Yr.	126	554-2 (N)
5544365	Aluminum	4-Spring Steel	Yes	900W / 60:1	3 Yr.	128	554-2 (N)
5544395	Aluminum	4-Spring Steel	Yes	600W / 90:1	3 Yr.	128	554-2 (N)
5544006	Aluminum	4-Spring Steel	No	600W / 90:1	1 Yr.	126	554-2 (N)
5544306	Aluminum	4-Spring Steel	No	600W / 90:1	3 Yr.	126	554-2 (N)
5544366	Aluminum	4-Spring Steel	No	900W / 60:1	3 Yr.	128	554-2 (N)
5544396	Aluminum	4-Spring Steel	No	900W / 90:1	3 Yr.	128	554-2 (N)
5546000	Aluminum	15-Coil Torsion	Yes	600W / 90:1	1 Yr.	126	554-2 (N)
5546300	Aluminum	15-Coil Torsion	Yes	600W / 90:1	3 Yr.	126	554-2 (N)
5546365	Aluminum	15-Coil Torsion	Yes	900W / 60:1	3 Yr.	128	554-2 (N)
5546395	Aluminum	15-Coil Torsion	Yes	600W / 90:1	3 Yr.	128	554-2 (N)
5546006	Aluminum	15-Coil Torsion	No	600W / 90:1	1 Yr.	126	554-2 (N)
5546306	Aluminum	15-Coil Torsion	No	600W / 90:1	3 Yr.	126	554-2 (N)
5546366	Aluminum	15-Coil Torsion	No	900W / 60:1	3 Yr.	128	554-2 (N)
5546396	Aluminum	15-Coil Torsion	No	900W / 90:1	3 Yr.	128	554-2 (N)
5548000	Steel	4-Spring Steel	Yes	600W / 90:1	1 Yr.	117	554-2 (N)
5548006	Steel	4-Spring Steel	No	600W / 90:1	1 Yr.	104	554-2 (N)
5548300	Steel	4-Spring Steel	Yes	600W / 90:1	3 Yr.	117	554-2 (N)
5548306	Steel	4-Spring Steel	No	600W / 90:1	3 Yr.	104	554-2 (N)
5548365	Steel	4-Spring Steel	Yes	900W / 60:1	3 Yr.	117	554-2 (N)
5548366	Steel	4-Spring Steel	No	900W / 60:1	3 Yr.	104	554-2 (N)
5548395	Steel	4-Spring Steel	Yes	900W / 90:1	3 Yr.	126	554-2 (N)
5548396	Steel	4-Spring Steel	No	900W / 90:1	3 Yr.	114	554-2 (N)
Fits 14' - 23' Dumps							
5545000	Aluminum	5-Spring Steel	Yes	600W / 90:1	1 Yr.	142	554-2 (N)
5545300	Aluminum	5-Spring Steel	Yes	600W / 90:1	3 Yr.	142	554-2 (N)
5545365	Aluminum	5-Spring Steel	Yes	900W / 60:1	3 Yr.	144	554-2 (N)
5545395	Aluminum	5-Spring Steel	Yes	900W / 90:1	3 Yr.	144	554-2 (N)
5545006	Aluminum	5-Spring Steel	No	600W / 90:1	1 Yr.	142	554-2 (N)
5545306	Aluminum	5-Spring Steel	No	600W / 90:1	3 Yr.	142	554-2 (N)
5545366	Aluminum	5-Spring Steel	No	900W / 60:1	3 Yr.	144	554-2 (N)
5545396	Aluminum	5-Spring Steel	No	900W / 90:1	3 Yr.	144	554-2 (N)
5547000	Aluminum	15-Coil Torsion	Yes	600W / 90:1	1 Yr.	142	554-2 (N)
5547300	Aluminum	15-Coil Torsion	Yes	600W / 90:1	3 Yr.	142	554-2 (N)
5547365	Aluminum	15-Coil Torsion	Yes	900W / 60:1	3 Yr.	144	554-2 (N)
5547395	Aluminum	15-Coil Torsion	Yes	900W / 90:1	3 Yr.	144	554-2 (N)
5547006	Aluminum	15-Coil Torsion	No	600W / 90:1	1 Yr.	142	554-2 (N)
5547306	Aluminum	15-Coil Torsion	No	600W / 90:1	3 Yr.	142	554-2 (N)
5547366	Aluminum	15-Coil Torsion	No	900W / 60:1	3 Yr.	144	554-2 (N)
5547396	Aluminum	15-Coil Torsion	No	900W / 90:1	3 Yr.	144	554-2 (N)
5549000	Steel	5-Spring Steel	Yes	600W / 90:1	1 Yr.	126	554-2 (N)
5549006	Steel	5-Spring Steel	No	600W / 90:1	1 Yr.	114	554-2 (N)
5549300	Steel	5-Spring Steel	Yes	600W / 90:1	3 Yr.	126	554-2 (N)
5549306	Steel	5-Spring Steel	No	600W / 90:1	3 Yr.	114	554-2 (N)
5549365	Steel	5-Spring Steel	Yes	900W / 60:1	3 Yr.	126	554-2 (N)
5549366	Steel	5-Spring Steel	No	900W / 60:1	3 Yr.	114	554-2 (N)
5549395	Steel	5-Spring Steel	Yes	900W / 90:1	3 Yr.	126	554-2 (N)
5549396	Steel	5-Spring Steel	No	900W / 90:1	3 Yr.	114	554-2 (N)

See pg. F12 for Tarps

Electric Tarp Systems

Electric Tarp Gear Motors









600W
5541095
5543095



900W
5541065
5543965
5541895
5543895

- 3-1/8" x 3/4" output shaft
- Bronze alloy gear for extended life
- 5 Mounting holes, fits all 3 and 4-bolt configurations
- Includes 5541006 chrome cover
- Retail packaged

Part No.	Description	Warranty	Watts	HP	Gear Ratio	RPM	Compares To	Wt. (lbs.)	Cat.
 5541095	BEST SELLER	1 Yr.	600	0.8	90:1	40	Donovan® 61X* & 61L*, Roll-Rite® 1030/1031*, US Tarp® 11521/13655*, Tarps & Beyond® 5000XT90*	13.25	554-3 (N)
 5543095	EXTENDED WARRANTY	3 Yr.	600	0.8	90:1	40	Donovan® 61G*	13.25	554-3 (N)
 NEW 5541895	HIGH TORQUE	1 Yr.	900	0.8	90:1	40	Donovan® 4 0909*, Aero® Power Plus RS/RA*, Shur-Co® 1703823*, Super Winch® 719527*, Mountain Tarp K0170*	13.25	554-3 (N)
 5543895	EXTENDED WARRANTY, HIGH TORQUE	3 Yr.	900	1.2	90:1	40	Donovan® 4 0909*, Aero® Power Plus RS/RA*, Shur-Co® 1703823*, Super Winch® 719527*, Mountain Tarp K0170*	13.5	554-3 (N)
 5541065	HIGH SPEED	1 Yr.	900	1.2	60:1	60	Roll-Rite® Tarp Master 10360*, US Tarp® 11521/13655*, Tarps & Beyond® 5000XT60*, Mountain Tarp K0170S*	13.5	554-3 (N)
 5543965	EXTENDED WARRANTY, HIGH SPEED	3 Yr.	900	1.2	60:1	60	Roll-Rite® Tarp Master 10310*	13.5	554-3 (N)

Gear Motor Cover



5541005

- Chrome-plated plastic tarp gear motor cover replacement
- Protects tarp gear motors from the elements
- Retail packaged

Part No.	Description	Compares To	Wt. (lbs.)	Cat.
5541005	Fits 600W Motors	Donovan® 4278*	0.59	554-3 (N)
5541006	Fits 600-900W Motors	Donovan® 4278*	0.65	554-3 (N)

Wind Deflector



3011874



3011871



3011873

- 98" Long x 7-1/2" Tall x 1" Return
Comparable to: Donovan® 1216*

Part No.	Description	Wt. (lbs.)	Cat.
3011871	Aluminum Wind Deflector, Partial Top	12	554-3 (N)
3011873	End Plate, DS for 3011871	1.45	554-3 (N)
3011874	End Plate, PS for 3011871	1.45	554-3 (N)

*Buyers Products is not authorized by nor affiliated with the manufacturer of Donovan®, Roll-Rite®, US Tarp®, Tarps & Beyond®, Pulltarp®, Aero®, Shur-Co®, Super Winch®, Mountain Tarp Inc. products.

Tension Bow



- Prevents tarp from flapping in transit
- Works with Buyers electric and manual tarp arms (Works with all Buyers tarp kits with arms)
- Extruded aluminum tubing, cast aluminum corners, and poly bumpers included
- 30° (3011868), 45° (3036900) and 60° (3036901) tarp joints sold separately

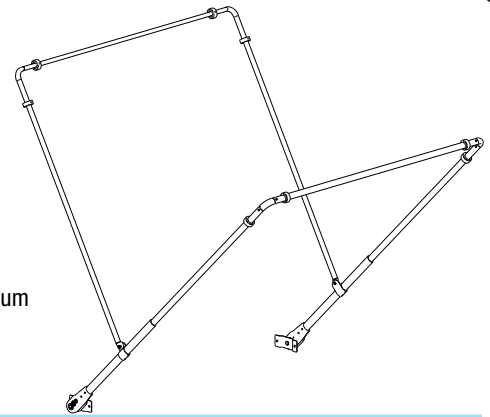

Part No.	Description	Cat.
NEW 5540000	Aluminum Tarp Tension Bow	554-3 (N)

Aluminum Arm Kits

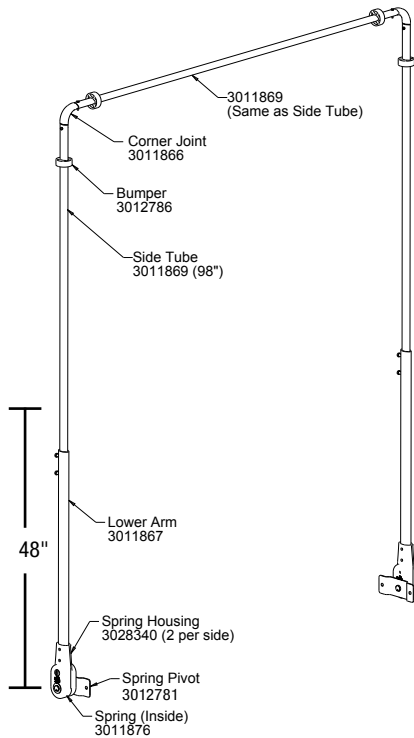

- 4 Spring
- New cast aluminum spring housing
- Side tube telescopes for 8' - 19' dump bodies

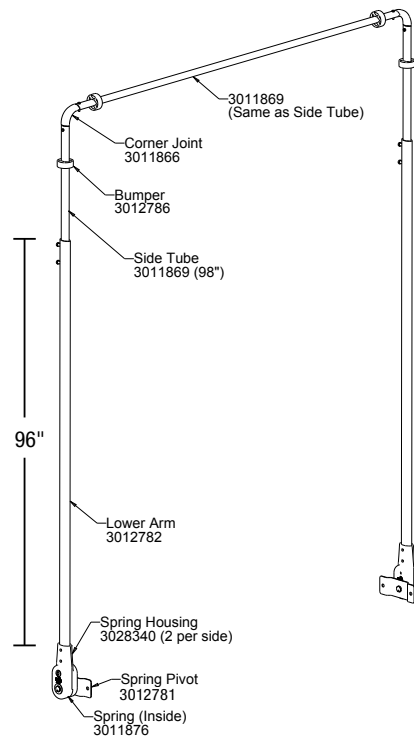

- 5 Spring
- New cast aluminum spring housing
- Side tube telescopes for 14' - 23' dump bodies

Part No.	Description	Wt. (lbs.)	Cat.
3016666	Universal Aluminum Tarp Arm Kit	59	554-3 (N)
3016667	Universal Aluminum Tarp Arm Kit	75	554-3 (N)

* Buyers Products is not authorized by nor affiliated with the manufacturer of Roll-Rite®

Tarp Arm Bumper



- 3-1/2" dia. x 1-1/4" wide
- Molded polyethylene with nut insert lock

Part No.	Description	Wt. (lbs.)	Cat.
3012786	Tarp Arm Bumper	0.27	554-3 (N)

Arm Joints



- Provides extra tarp arm clearance for trucks with tall cabs
- For use with Buyers electric tarp kits and manual tarp arm kits

Part No.	Description	Wt. (lbs.)	Cat.
3011868	30° Aluminum Tarp Arm Joint	1.66	554-3 (N)
3036900	45° Aluminum Tarp Arm Joint	1.51	554-3 (N)
3036901	60° Aluminum Tarp Arm Joint	1.51	554-3 (N)



Electric Tarp Systems

Tarp Arm Accessories



- Used with electric and manual tarp arm systems
- Provides extra tarp arm support
- Reduces noise and wear from tarp arm rattle
- Includes rubber landing pad
- *Comparable to:*
Roll-Rite® 4695

Part No.	Description	Wt. (lbs.)	Cat.
NEW 5540001	Aluminum Tarp Stop Bracket Kit (Pair)	2.5	554 (Y)



- Used with electric and manual tarp arm systems
- Provides extra tarp arm support
- Reduces noise and wear from tarp arm rattle
- 8" L x 2-1/2" W x 3" H
- *Comparable to:*
Roll-Rite® 7660

Part No.	Description	Wt. (lbs.)	Cat.
NEW 5540002	Rubber Tarp Centering Wedge (Pair)	1.23	554 (Y)

Underbody Pivot Spring



3024913



3024912

- 5/8", 15-Coil torsion spring
- 3,900 lbs

Part No.	Description	Wt. (lbs.)	Cat.
3024913	Spring, DS	8.14	554-3 (N)
3024912	Spring, PS	8.14	554-3 (N)

Underbody Spring Pivot Assembly



- For electric underbody systems
- Bearings and all mounting hardware included
- 5/8", 15-Coil torsion spring
- *Comparable to:* Mountain Tarp® K0511B*(DS) K0512B*(PS)

Part No.	Description	Wt. (lbs.)	Cat.
3024915	Underbody Spring Assembly, DS	20.5	554-3 (N)
3024916	Underbody Spring Assembly, PS	20.5	554-3 (N)

Tarp Axle



- 97" Long x 2" Diameter
- Multi-mount 3/4" tarp hole axle
- Accepts screw-in and slide-in tarps

Part No.	Description	Wt. (lbs.)	Cat.
3011870	Tarp Axle	14	554-3 (N)

Spiral Torsion Spring



- 5/8" wide
- Tempered spring steel
- Black powder coated
- *Comparable to:*
Donovan® 2416*
Roll-Rite® 4723*
US Tarp® 11121*
Mountain Tarp K0199*

Part No.	Description	Wt. (lbs.)	Cat.
3011876	Universal Flat Coil Spring	1.1	554-3 (N)

Electrical Parts and Accessories



- Solenoid with cover
- Rocker switch with bracket
- Circuit breaker
- Wire harness

Part No.	Description	Wt. (lbs.)	Cat.
NEW 5541020	Rocker Switch Kit (Everything Needed to Operate Tarp Gearmotor)	.005	554-3 (N)



- 150A ground coils
 - Silver plated contacts
 - Ideal for any application that requires reversing motion
 - Optional cover sold separately
- Comparable to:
Donovan® 1464*, Roll-Rite 10690*

Part No.	Description	Wt. (lbs.)	Cat.
1306600	Solenoid Switch	0.76	900 (N)
3014186	Optional Solenoid Cover	0.08	560 (N)



- 12V, 80A
 - Sealed, weatherproof
 - 6 terminal poles
- Comparable to:
Cole Hersee 24452*
Mountain Tarp K0176M*
US Tarp 13994 EZ Relay*

Part No.	Description	Wt. (lbs.)	Cat.
NEW 5541100	Motor Reversing Relay	0.54	554 (N)

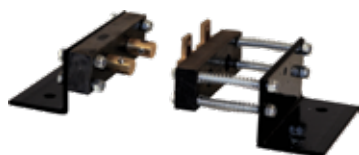

- 12V
 - Reduces wire length on long dumps
- Comparable to:
Donovan® 1379A*
Mountain Tarp K0141*

Part No.	Description	Wt. (lbs.)	Cat.
3015127	Contact Plate	3	554-3 (N)



- 2-Way trailer connectors
 - Die-cast metal and round pins
 - Trailer end with cable guard spring
- Comparable to:
Donovan® 3848*, Roll-Rite® 1267* (truck end)
US Tarp® 11544* (truck end), Roll-Rite® 1268* (trailer end), US Tarp® 11545* (trailer end)



Part No.	Description	Wt. (lbs.)	Cat.
TC1012	Truck End, Vertical	0.68	542 (N)
TC1002	Truck End, Horizontal	0.68	542 (N)
TC2012	Trailer End, Vertical	0.74	542 (N)
TC2002	Trailer End, Horizontal	0.74	542 (N)



- 50A rotary switch
 - Switch bracket
 - Red indicator light
 - 40A circuit breaker
- Comparable to:
Donovan® 85N*, Roll-Rite®
1050*, US Tarp® 11479*,
Mountain Tarp K0176*



- Comparable to:
Donovan® 600*,
Roll-Rite® 1905*,
US Tarp® 11129*,
Mountain Tarp K017E*

Part No.	Description	Wt. (lbs.)	Cat.
5540710	Rotary Switch Kit	1.09	554-3 (N)
SW710	Heavy Duty Rotary Switch	0.39	639 (N)



- 12V
 - Double momentary open/close
 - Switch and bracket sold separately
- Comparable to:
Donovan® 1897* (switch)
Donovan® 1532* (bracket)
Roll-Rite 19300* (switch)
Roll-Rite 10390* (bracket)

Part No.	Description	Wt. (lbs.)	Cat.
3014187	Rocker Switch	0.1	639 (N)
3014188	Rocker Switch Mounting Bracket	0.25	554-3 (N)



- 12V
 - Auto reset
- Comparable to:
Donovan® 1461*

Part No.	Description	Wt. (lbs.)	Cat.
NEW CB50	50 A Circuit Breaker	0.23	560 (N)
CB60	60 A Circuit Breaker	0.23	560 (N)

*30-250 A also available



- Copper wire
- Three conductor
- 20'

Part No.	Description	Wt. (lbs.)	Cat.
3014217	14 Gauge Wire, 3 Conductor	1.5	554-3 (N)



- Copper wire
 - Dual conductor
 - 60'
- Comparable to:
Donovan® 88* (6 gauge)
Roll-Rite® 1133* (6 gauge)
US Tarp® 11148* (6 gauge)
Donovan® 2141* (8 gauge)

Part No.	Description	Wt. (lbs.)	Cat.
3012783	6 Gauge Wire, Dual Conductor	15.4	554-3 (N)
3020919	8 Gauge Wire, Dual Conductor	10.5	554-3 (N)



- Quick connects
 - Used with 6 gauge wire
 - 2 per kit
- Comparable to:
Donovan® 3799*,
Mountain Tarp K0144*

Part No.	Description	Wt. (lbs.)	Cat.
5601015	Connector Kit	0.78	560 (N)

* Buyers Products is not authorized by nor affiliated with the manufacturer of Donovan®, Roll-Rite®, US Tarp®, Tarps & Beyond®, Pulltarp®, Aero®, Shur-Co®, Super Winch®, Mountain Tarp Inc. products.

Manual Tarp Systems

Crank Arm Tarp Systems



Die-cast aluminum housing, protects springs and strengthens arm joints



Tarp crank with friction brake



10' nickel-plated chain and shaft assembly with 18T sprocket

- Telescoping, aluminum pivot arms
- Tarp crank with friction brake
- **Includes:** Aluminum arms & pivots, 10' chain, 3 spring pivot, bumpers, torsion springs, cast corner joints, mounting hardware
- Tarps sold separately (Page F12)

Part No.	# of Springs	Wind Deflector	Wt. (lbs.)	Cat.
5543000	3	Yes	97	554-2 (N)
5543006	3	No	85	554-2 (N)

See pg. F12 for Tarps

Optional aluminum wind deflector Adjustable poly arm guides

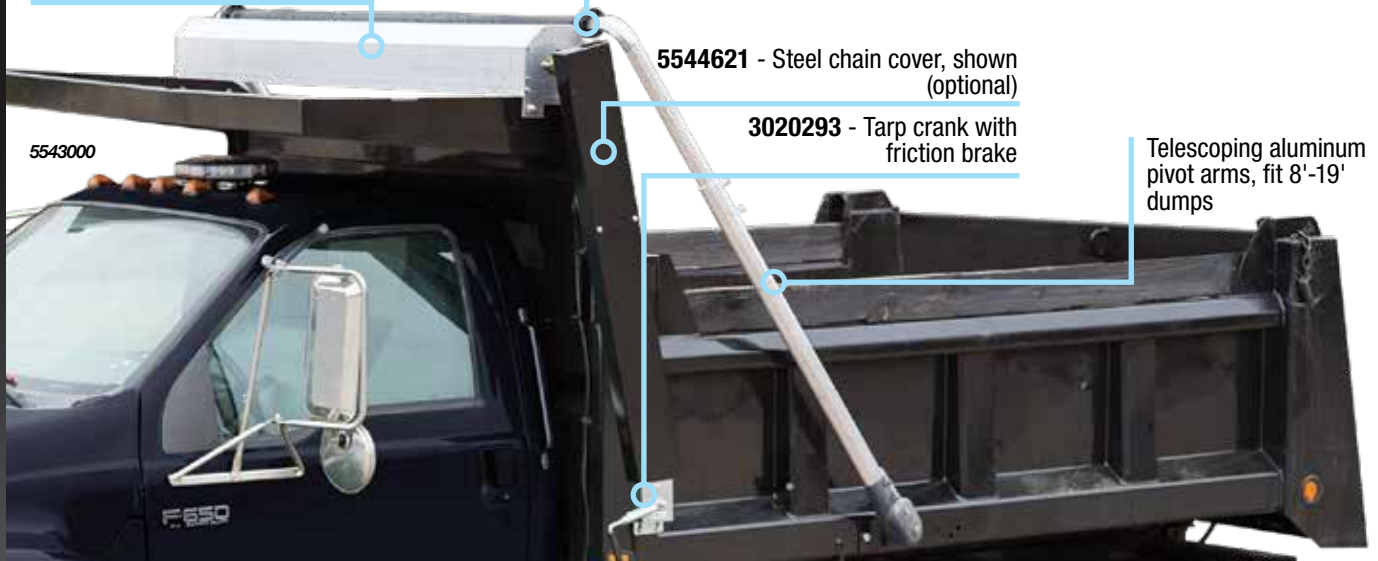

5544621 - Steel chain cover, shown (optional)

3020293 - Tarp crank with friction brake

Telescoping aluminum pivot arms, fit 8'-19' dumps

Tapered Cab Shield DTR Mounting Brackets



- Provides a 'square' mounting surface for dump bodies with tapered cab shields
- Black powder coated steel

Chain Cover



5544621

5544622

Part No.	Description	Wt. (lbs.)	Cat.
3031692	Used on Crysteel® Dump Body	7	554-3 (N)
3031808	Used on Rugby® Dump Body	7	554-3 (N)

Part No.	Description	Wt. (lbs.)	Cat.
5544621	DTG Chain Cover, Black Steel	19	554-3 (N)
5544622	DTG Chain Guard, Aluminum	4.68	554-3 (N)

Optional Wind Deflector



- 98" Long x 8" Tall x 4"

Part No.	Description	Wt. (lbs.)	Cat.
3026462	Aluminum Wind Deflector, Full Top	16.93	554-3 (N)
3026457	End Plate, DS for 3026462	1.45	554-3 (N)
3026458	End Plate, PS for 3026462	1.45	554-3 (N)

Crank Arm Drive



Part No.	Description	Wt. (lbs.)	Cat.
3013299	10' Nickel Plated Chain with Master Link	4.34	554 (N)
3024748	3/4" x 14" Shaft Assembly with 18T Sprocket	2.17	554-3 (N)

Works with 5543000 and 5543006 tarp systems

Pull-Style Tarp Systems with Spring Assist

- Spring assist helps keep tension for easy retracting
- 98" Aluminum anti-sail tarp retention bow set with poly arm stops
- **Includes:** 20' pull rope, wind deflector, aluminum end plates, tarp retention bow catch plate, tarp, mounting hardware
- **Ships pre-assembled with tarp on roller under tension** (except 5542000 & 5542090)

Part No.	Description	Housing Length	Tarp Dimensions	Wt. (lbs.)	Cat.
554275150	Aluminum Tarp System with Mesh Tarp	96"	7-1/2' x 15'	102	554-2 (N)
554275152	Aluminum Tarp System with Solid Tarp	96"	7-1/2' x 15'	108	554-2 (N)
554270150	Aluminum Tarp System with Mesh Tarp	91"	7' x 15'	101	554-2 (N)
554270152	Aluminum Tarp System with Solid Tarp	91"	7' x 15'	105	554-2 (N)
554270155	Aluminum Tarp System with Mesh Tarp	88"	7' x 15'	100	554-2 (N)
554270156	Aluminum Tarp System with Solid Tarp	88"	7' x 15'	102	554-2 (N)
554265150	Aluminum Tarp System with Mesh Tarp	82"	6-1/2' x 15'	100.5	554-2 (N)
554260140	Aluminum Tarp System with Mesh Tarp	76"	6' x 14'	99.5	554-2 (N)
554250120	Aluminum Tarp System with Mesh Tarp	64"	5' x 12'	97.5	554-2 (N)
5542000	96" Aluminum Tarp System Hardware Kit Only	96"	-	92	554-2 (N)
5542090	91" Aluminum Tarp System Hardware Kit Only	91"	-	90.5	554-2 (N)

See pg. F12 For Tarps

Optional DTB Retention Bow Catch Plate



Part No.	Description	Wt. (lbs.)	Cat.
NEW 3029712	Tarp Retention Bow Catch Plate	0.79	554-3 (N)



554275150

Manual Dump Tarp Systems

All Kits Include

- Tarp rollers with telescoping extruded aluminum cross bars to fit exact width of truck
- **NEW** Aluminum tarp deflector and housing (TDH systems only)
- 20' rope
- Tarp (unless noted)
- (4) rope tie down hooks
- (2) 15" rubber straps with S-hook
- Mounting hardware

PLUS: Your choice of crank (included)

UNIVERSAL

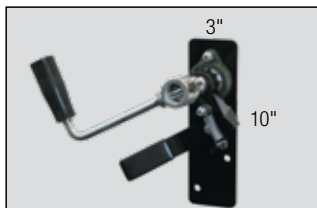

3" bearing bolt center mounting is used on all kits with a **DTR** prefix

RUGBY DUMP BODY/STYLE



3-1/2" bearing bolt centers available as kit **DTR1**. Tarp sold separately

GROUND CRANK WITH CHAIN



Available as kit **DTG**. Tarp sold separately

Options

Chain Cover



5544621



5544622

Part No.	Description	Wt. (lbs.)	Cat.
5544621	DTG Chain Cover, Black Steel	19	554-3 (N)
NEW 5544622	DTG Chain Guard, Aluminum	4.68	554-3 (N)

Rear Anti-Sail Tarp Retention Bow Set Options



- Fits into rear pocket sleeve

Part No.	Description	Wt. (lbs.)	Cat.
DTB96	96" Black Powder Coated	11.5	554-3 (N)
DTB98A	98" Aluminum	8.0	554-3 (N)
DTB102	102" Black Powder Coated	14.0	554-3 (N)



NEW
TDH7515

One-piece, extruded aluminum wind deflector

DTB102 Tarp Tension Bow (optional)

Standard sewn-in pocket works with optional DTB96, DTB98A and DTB102 rear anti-sail tarp retention bow sets

20' Pull rope with snap hook

DTR7015

With Aluminum Deflector and Housing

Part No.	Description	Dimensions	Wt. (lbs.)	Cat.
TDH7512	7.5' x 12' Black Mesh	Yes	49.5	554-2 (N)
TDH7515	7.5' x 15' Black Mesh	Yes	51	554-2 (N)
TDH7518	7.5' x 18' Black Mesh	Yes	53	554-2 (N)

Roll Kits Without Tarp

Part No.	Description	Dimensions	Wt. (lbs.)	Cat.
DTR	Dump Tarp Roll Kit (less tarp), Universal	—	19.25	554 (Y)
DTR1	Dump Tarp Roll Kit (less tarp), for Pre-Drilled Rugby® Dump Body	—	16.25	554 (Y)
DTG	Tarp Roller Kit, with Ground Control (less tarp)	—	30.1	554 (Y)

DTR Roll Kits With Tarp Included

Part No.	Description	Dimensions	Wt. (lbs.)	Cat.
DTR4510	Aluminum Tarp System with Mesh Tarp	4-1/2' x 10'	23	554 (Y)
DTR5012	Aluminum Tarp System with Mesh Tarp	5' x 12'	24.75	554 (Y)
DTR5014	Aluminum Tarp System with Mesh Tarp	5' x 14'	25	554 (Y)
DTR5508	Aluminum Tarp System with Mesh Tarp	5-1/3' x 9-1/2'	24	554 (Y)
DTR5511	Aluminum Tarp System with Mesh Tarp	5-1/3' x 11-1/2'	25	554 (Y)
DTR5514	Aluminum Tarp System with Mesh Tarp	5-1/2' x 14'	28	554 (Y)
DTR6014	Aluminum Tarp System with Mesh Tarp	6' x 14'	28	554 (Y)
DTR6016	Aluminum Tarp System with Mesh Tarp	6' x 16'	27.01	554 (Y)
DTR6515	Aluminum Tarp System with Mesh Tarp	6-1/2' x 15'	29	554 (Y)
DTR6518	Aluminum Tarp System with Mesh Tarp	6-1/2' x 18'	28.5	554 (Y)
DTR7012	Aluminum Tarp System with Mesh Tarp	7' x 12'	26.55	554 (Y)
DTR7015	Aluminum Tarp System with Mesh Tarp	7' x 15'	31.5	554 (Y)
DTR7015S	Aluminum Tarp System with Solid Tarp	7' x 15'	36.5	554 (Y)
DTR7018	Aluminum Tarp System with Mesh Tarp	7' x 18'	33	554 (Y)
DTR7018S	Aluminum Tarp System with Solid Tarp	7' x 18'	40.5	554 (Y)
DTR7020	Aluminum Tarp System with Mesh Tarp	7' x 20'	35	554 (Y)
DTR7021S	Aluminum Tarp System with Solid Tarp	7' x 21'	43.5	554 (Y)
DTR7022	Aluminum Tarp System with Mesh Tarp	7' x 22'	35	554 (Y)
DTR7512	Aluminum Tarp System with Mesh Tarp	7-1/2' x 12'	29.5	554 (Y)
DTR7515	Aluminum Tarp System with Mesh Tarp	7-1/2' x 15'	31	554 (Y)
DTR7515S	Aluminum Tarp System with Solid Tarp	7-1/2' x 15'	38	554 (Y)
DTR7518	Aluminum Tarp System with Mesh Tarp	7-1/2' x 18'	33	554 (Y)
DTR7520	Aluminum Tarp System with Mesh Tarp	7-1/2' x 20'	36	554 (Y)
DTR7520S	Aluminum Tarp System with Solid Tarp	7-1/2' x 20'	42.5	554 (Y)
DTR8018	Aluminum Tarp System with Mesh Tarp	8' x 18'	33	554 (Y)
DTR8022	Aluminum Tarp System with Mesh Tarp	8' x 22'	37	554 (Y)

Tapered Cab Shield DTR Mounting Brackets
(optional see pg. F8)



DTB102 Tarp Tension Bow (optional)

Tarps

Heavy Duty Black Tarps

- Heavy duty double stitch hem
- Full perimeter brass grommets
- All hems reinforced with 2" heavy duty nylon webbing
- HD UV resistant, PVC coated vinyl with 1,000 denier polyester mesh
- Solid vinyl 18 oz. tarp is rated up to **330°F, for asphalt**

Part No.	Description	Dimensions (W x L)	Wt. (lbs.)	Cat.
3014480	Mesh	4-1/2' x 10'	4	554-1 (Y)
3011034	Mesh	5' x 12'	5.4	554-1 (Y)
3025044	Mesh	5' x 14'	6.2	554-1 (Y)
3014677	Mesh	5-1/3' x 9-1/2'	4.5	554-1 (Y)
3014481	Mesh	5-1/3' x 11-1/2'	5.33	554-1 (Y)
3011350	Mesh	5-1/2' x 14'	7	554-1 (Y)
3009455	Mesh	6' x 14'	7.5	554-1 (Y)
3036879	Mesh	6' x 16'	8.41	554-1 (Y)
3008976	Mesh	6-1/2' x 15'	8.5	554-1 (Y)
3009094	Mesh	6-1/2' x 18'	10	554-1 (Y)
3011036	Mesh	7' x 12'	7.3	554-1 (Y)
3008210	Mesh	7' x 15'	9.15	554-1 (Y)
3009456	Mesh	7' x 18'	11	554-1 (Y)
3009457	Mesh	7' x 20'	12.54	554-1 (Y)
3022116	Mesh	7' x 22'	13.91	554-1 (Y)
3013395	Mesh	7' x 24'	14.7	554-1 (Y)
3013396	Mesh	7' x 28'	17.15	554-1 (Y)
3011035	Mesh	7-1/2' x 12'	9.48	554-1 (Y)
3008209	Mesh	7-1/2' x 15'	9.8	554-1 (Y)
3009458	Mesh	7-1/2' x 18'	11.75	554-1 (Y)
3009095	Mesh	7-1/2' x 20'	12.85	554-1 (Y)
3013397	Mesh	7-1/2' x 24'	15.42	554-1 (Y)
3013398	Mesh	7-1/2' x 28'	18	554-1 (Y)
3022117	Mesh	8' x 18'	9.48	554-1 (Y)
3009892	Mesh	8' x 22'	15	554-1 (Y)
3016005	Mesh Roll-Off Container Tarp, Manual	12' x 24'	24.25	554-1 (Y)
3016006	Mesh Roll-Off Container Tarp, Manual	12' x 26'	26.25	554-1 (Y)
3011352	Solid, Asphalt	7' x 15'	13	554-1 (Y)
3011351	Solid, Asphalt	7' x 18'	15	554-1 (Y)
3016004	Solid, Asphalt	7' x 21'	22.37	554-1 (Y)
3011353	Solid, Asphalt	7-1/2' x 15'	16.05	554-1 (Y)
3011354	Solid, Asphalt	7-1/2' x 20'	17	554-1 (Y)

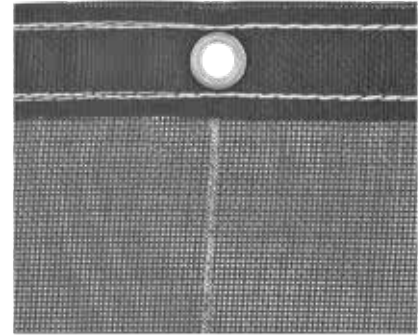

Mesh, 12 oz.

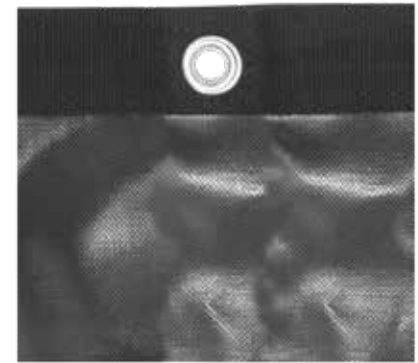

Solid Vinyl, 18 oz.
Asphalt rated to 330°F

Selecting the Right Tarp Size

Tarp length should typically be 2' to 3' longer than A & B combined. Tarp width should typically be no wider than C, provided it still covers the inside body width. Exceeding the dump body width can cause tarp to tangle when rolling up.

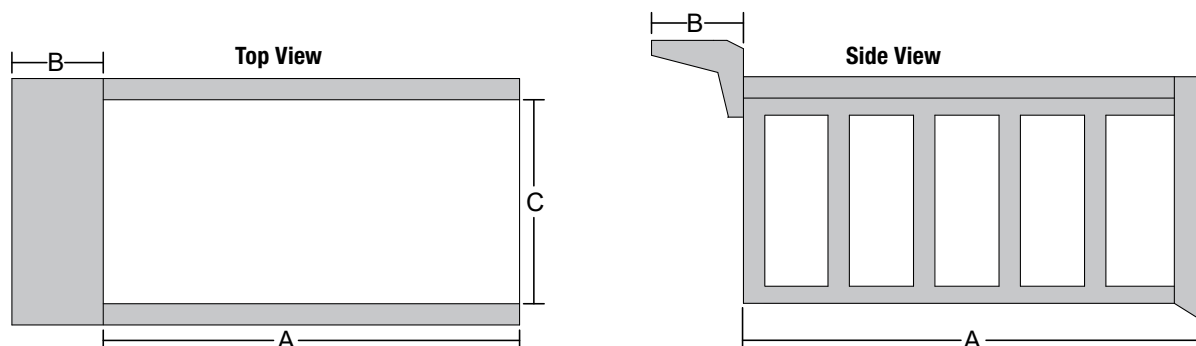

Rope Assembly



- 3/8" x 20' poly rope
- 3-5/16" snap hook
- Used on all manual DTR and Pull-Style tarp systems

Part No.	Description	Wt. (lbs.)	Cat.
3008225	20' Rope Assembly	0.65	520 (N)

Bearings



3012784

- 3/4" dia. flange bearing
- 3-1/4" bolt centers



1411000

- 1" dia. flange bearing
- 3" bolt centers

Part No.	Description	Wt. (lbs.)	Cat.
3012784	Stamped Flange Bearing, 3/4" Dia.	0.46	554-3 (N)
1411000	Cast Flange Bearing, 1" Dia.	0.86	554-3 (N)

Square Gudgeon



- 1-1/2" Cast steel tarp gudgeon
- Fits 2" pipe
- 3/4" Square key replacement
- Interchanges with Shur-Co 1105033*

Part No.	Description	Wt. (lbs.)	Cat.
3027070	Square Gudgeon	0.64	554-3 (N)

Tarp Joints



3001894

- Used with ground control tarp rollers
- Zinc Plated

Part No.	Description	Wt. (lbs.)	Cat.
3001894	Roll Tarp Joint, 1-1/4" R, 3/8" PH x 1-3/8" 21	4.64	520 (N)
3001895	Male 21 Spline x 1-13/16" Male Stub Shaft	1.54	520 (N)
3012784	3/4" Flange Bearing with 3-1/4" Bolt Centers	0.46	554-3 (N)

Tarp Cranks



3035381



3020293

Part No.	Description	Wt. (lbs.)	Cat.
3035381*	Ground Level Crank	30.1	554 (N)
3020293**	Tarp Crank with Friction Brake	6.44	554-3 (N)

*Used with DTG ground control systems

**Used with 5543000 and 5543006 systems

Comparable to Donovan 441 and Shur-Co 1800088

Manual Dump Tarp System Parts

Binding Hooks



- Weld-on
- 1/2" Round cross section
- 5" Length
- 11/32" Mounting holes (B2448C)



- 3/8" Round cross section
- 3-1/4" Length
- 9/13" Mounting holes

Part No.	Description	Wt. (lbs.)	Cat.
B2448	Plain Finish Binding Hook	0.29	700 (N)
B2448C	Zinc Plated Binding Hook	0.29	700 (N)
B2447NHP	Weld-On Tarp Hook (No Holes)	0.14	700 (N)
B2447BZ	Zinc Plated Tarp Hook	0.13	700 (N)
B2447WAL	Weld-On Alum. Tarp Hook (No Holes)	0.15	700 (N)

Rope Clip



- Die-cast zinc



Part No.	Description	Wt. (lbs.)	Cat.
B450	Zinc Cast Rope Clip	0.11	700 (N)

Rubber Tarp Straps

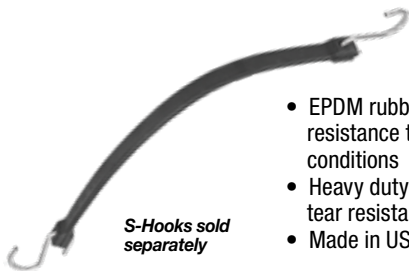

S-Hooks sold separately

- EPDM rubber provides outstanding resistance to extreme weather conditions
- Heavy duty square ends for strength/tear resistance
- Made in USA



- Sold separately from tarp straps
- 0.180" diameter
- Zinc plated

Part No.	Description	Wt. (lbs.)	Cat.
TS9	9" Rubber Tarp Strap (100/carton)	0.11	350 (Y)
TS15	15" Rubber Tarp Strap (100/carton)	0.12	350 (Y)
TS20	20" Rubber Tarp Strap (100/carton)	0.15	350 (Y)
TS31	31" Rubber Tarp Strap (50/carton)	0.25	350 (Y)
TS41	41" Rubber Tarp Strap (50/carton)	0.30	350 (Y)
9225	2.5" S-Hook (100/carton)	4	360 (N)

CARGO CONTROL

Buyers Cargo Control has every component to secure your load from D-rings to winches and load binders.

D-RINGS

NEW Forged Stake Pocket D-Rings

G2

G3

ROPE RINGS

G5

EYE BOLTS & TRAILER TIE DOWN HARDWARE

G9

TRAILER OUTRIGGERS

G10

NEW 7" Cast Steel Removable Outrigger

G10

WINCHES & WINCH HARDWARE

G11

TIE DOWN STRAPS

G13

E-TRACK

G14

LADDER RACK TIE-DOWNS

G16

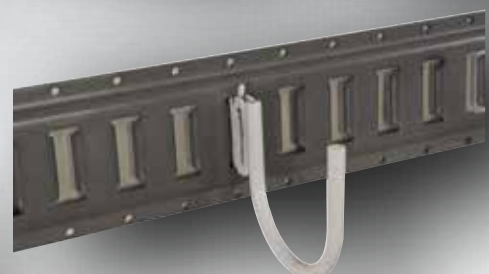
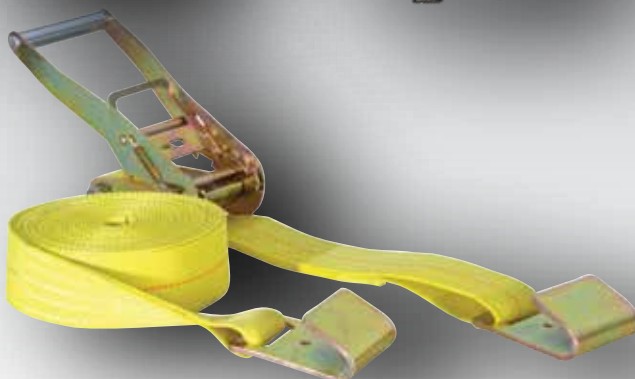

Forged D Rings

Rotating 1" Forged D-Ring



- Forged 1" dia. ring
- Rotates for optimum strapping angle
- D-Rings are not approved for overhead use

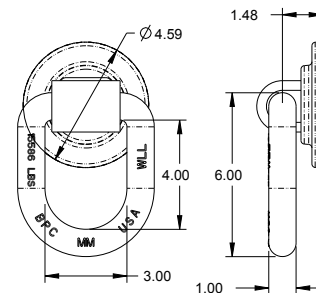

Part No.	Description	Ring DIA.	I.D. (H X W)	W.L.L. (lbs.)	Ultimate Breaking Strength (lbs.)	Wt. (lbs.)	Cat.
B51	Forged 360° Rotating D-Ring, with Mounting Bracket	1"	4" x 3"	15,586	46,758	7.1	524 (N)

Rotating Angled 1" Forged D-Ring



- Forged 1" dia. 55° bend - makes it easier to attach strap or chain
- Rotates for optimum strapping angle
- D-Rings are not approved for overhead use

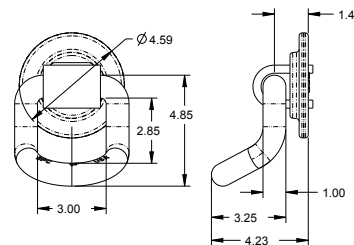

Part No.	Description	Ring DIA.	I.D. (H X W)	W.L.L. (lbs.)	Ultimate Breaking Strength (lbs.)	Wt. (lbs.)	Cat.
B52	Forged 360° Rotating D-Ring, (55°) with Mounting Bracket	1"	3½" x 3"	15,586	46,758	7.1	524 (N)

1/2" Forged D-Rings



- Forged from C-1045 steel
- 1/2" diameter ring
- Includes weld-on or 2-Hole mounting bracket
- Forged bracket is 2" wide & 1-1/16" thick
- 2-Hole bracket is 1-3/4" wide & 3/16" thick with square mounting holes to accept 3/8" carriage bolts
- D-Rings are not approved for overhead use

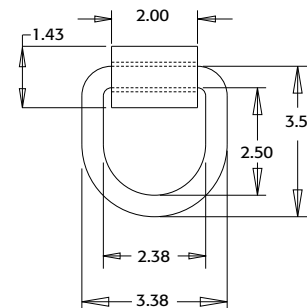

Part No.	Description	Ring DIA.	I.D. (H X W)	W.L.L. (lbs.)	Ultimate Breaking Strength (lbs.)	Wt. (lbs.)	Cat.
B38	Forged D-Ring with 2-Hole Mounting Bracket	1/2"	2-1/2" x 2-3/8"	4,080	12,240	1.0	524 (N)
B38W	Forged D-Ring with Weld-On Mounting Bracket	1/2"	2-1/2" x 2-3/8"	4,080	12,240	1.0	524 (N)
B38ZW	Forged White Zinc Plated D-Ring with 2-Hole Mounting Bracket	1/2"	2-1/2" x 2-3/8"	4,080	12,240	1.0	524 (N)
B38ZY	Forged Yellow Zinc Plated D-Ring with 2-Hole Mounting Bracket	1/2"	2-1/2" x 2-3/8"	4,080	12,240	1.0	524 (N)
02040	Retail Packaged B38ZY, Must Order in Multiple of 5	1/2"	2-1/2" x 2-3/8"	4,080	12,240	1.0	524 (N)

Bolt-On 1/2" Forged D-Ring With Recessed Pan Mount



- Forged from C-1045 steel for durability
- Recessed pan mount makes for sturdy hold
- D-rings are not approved for overhead use

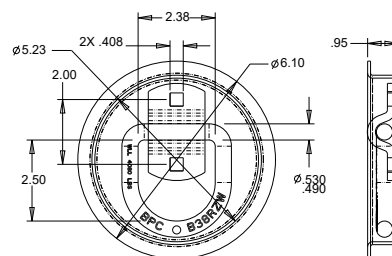

Part No.	Description	Ring DIA.	I.D. (H X W)	W.L.L. (lbs.)	Ultimate Breaking Strength (lbs.)	Wt. (lbs.)	Cat.
B38RP	Forged D-Ring with 2-Hole Mounting Bracket with Recessed Pan	1/2"	2-1/2" x 2-3/8"	4,080	12,240	1.8	524 (N)
3009093	Recessed Pan Mounted for B38RP, Clear Zinc Plated, Only					.9	524(N)

Single Bolt Mounted 1/2" Forged D-Ring



- Forged from C-1045 steel
- 1/2" diameter ring
- Integral bracket is 1-3/4" wide & 3/8" thick with square mounting hole to accept 3/8" carriage bolts
- D-Rings are not approved for overhead use
- **Includes:** Integral one-hole mounting bracket

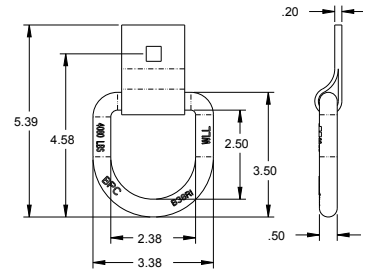

Part No.	Description	Ring DIA.	I.D. (H X W)	W.L.L. (lbs.)	Ultimate Breaking Strength (lbs.)	Wt. (lbs.)	Cat.
B38S	Forged D-Ring with Integral Bracket	1/2"	2-1/2" x 2-3/8"	4,080	12,240	1.2	524 (N)

Forged Stake Pocket D-Ring

- Fits common flush and outside stake pockets
- Provides convenient D-Ring tie down where needed
- D-Rings are not approved for overhead use
- **Includes:** 1/2" hitch pin with cotter



B38SP



B32SPZ



B28SP



B38SP application

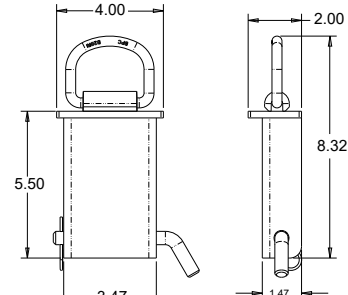
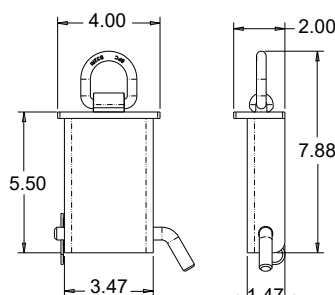
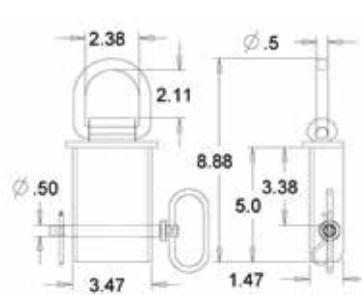

Part No.	Description	Ring DIA.	I.D. (H X W)	Wt. (lbs.)	Cat.
B38SP	Forged Stake Pocket D-Ring, Black Powder Coated	1/2"	2-1/2" x 2-3/8"	3.38	524 (N)
B28SP	Forged Stake Pocket D-Ring, Black Powder Coated	3/8"	2" x 2-1/2"	3.22	524 (N)
B28SPZ	Forged Stake Pocket D-Ring, Zinc Plated	3/8"	2" x 2-1/2"	3.22	524 (N)
B32SP	Forged Stake Pocket D-Ring, Black Powder-Coated	3/8"	1.44" x 1.50"	2.82	524 (N)
B32SPZ	Forged Stake Pocket D-Ring, Zinc Plated	3/8"	1.44" x 1.50"	3.22	524 (N)

Extended 1/2" Forged D-Ring



- Forged from C-1045 steel
- 1/2" diameter ring
- Forged bracket is AISI-1025 steel
- D-Rings are not approved for overhead use
- **Includes:** Weld on mounting bracket

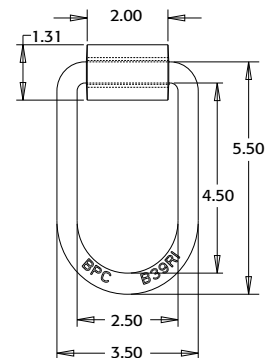

Part No.	Description	Ring DIA.	I.D. (H X W)	W.L.L. (lbs.)	Ultimate Breaking Strength (lbs.)	Wt. (lbs.)	Cat.
B39W	Forged D-Ring with Integral Bracket	1/2"	4-1/2" x 2-1/2"	4,080	12,240	1.21	524 (N)



Forged D Rings

5/8" Forged D-Ring



- Forged from C-1045 steel
- 5/8" diameter ring
- Forged bracket is 2-1/2" wide & 3/8" thick AISI-1025 steel
- D-Rings are not approved for overhead use
- **Includes:** Weld on mounting bracket

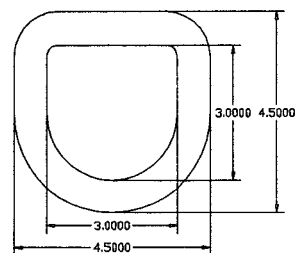

Part No.	Description	Ring DIA.	I.D. (H X W)	W.L.L. (lbs.)	Ultimate Breaking Strength (lbs.)	Wt. (lbs.)	Cat.
B40	Forged D-Ring with Mounting Bracket	5/8"	3" x 3"	6,130	18,390	2.0	524 (N)
02050	Retail Packaged B40, Must Order in Multiples of 10	5/8"	3" x 3"	6,130	18,390	2.0	524 (N)

Bolt-On 5/8" Forged D-Ring



- 5/8" diameter forged ring with 2-1/2" wide & 3/8" thick forged mounting bracket welded on 1/4" steel plate
- Bolt-on; no welding required
- Black powder coat finish
- 5" Square with 0.406" sq. punch holes
- D-Rings are not approved for overhead use
- **Includes:** D-Ring on plate, 2 back support, 4 carriage bolts, 4 nylock nuts

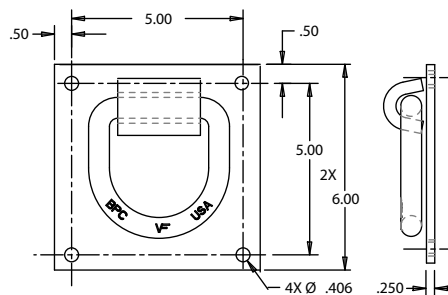

Part No.	Description	Ring DIA.	I.D. (H X W)	W.L.L. (lbs.)	Ultimate Breaking Strength (lbs.)	Wt. (lbs.)	Cat.
B40MP	Bolt-On D-Ring Kit	5/8"	3" x 3"	-	-	5.06	524 (N)

3/4" Forged D-Ring



- Forged from C-1045 steel
- 3/4" diameter ring
- Forged bracket is 2-1/4" wide & 3/8" thick
- D-Rings are not approved for overhead use
- **Includes:** Weld on mounting bracket

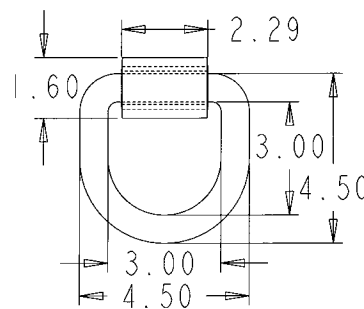

Part No.	Description	Ring DIA.	I.D. (H X W)	W.L.L. (lbs.)	Ultimate Breaking Strength (lbs.)	Wt. (lbs.)	Cat.
B46	Forged D-Ring with Mounting Bracket	3/4"	3" x 3"	9,120	27,360	2.5	524 (N)
B46BF	Forged Mounting Bracket for B46, Only	-	-	-	-	0.75	524 (N)

1" Forged D-Ring



- Forged from C-1045 steel
- 1" diameter ring
- Forged bracket is 2-1/8" wide & 1/2" thick
- D-Rings are not approved for overhead use
- **Includes:** Weld on mounting bracket

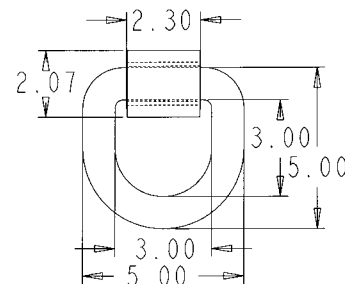



Part No.	Description	Ring DIA.	I.D. (H X W)	W.L.L. (lbs.)	Ultimate Breaking Strength (lbs.)	Wt. (lbs.)	Cat.
B48	Forged D-Ring with Mounting Bracket	1"	3" x 3"	15,586	46,758	4.2	524 (N)

Extended 1" Forged D-Ring

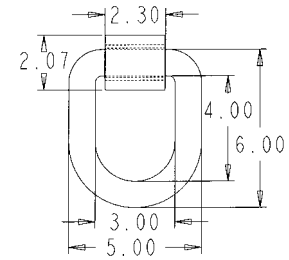

- Forged from C-1045 steel
- 1" diameter ring
- Forged bracket is 2-1/4" wide & 1/2" thick
- D-Rings are not approved for overhead use
- **Includes:** Weld on mounting bracket



Part No.	Description	Ring DIA.	I.D. (H X W)	W.L.L. (lbs.)	Ultimate Breaking Strength (lbs.)	Wt. (lbs.)	Cat.
B50	Forged D-Ring with Mounting Bracket	1"	4" x 3"	15,586	46,758	4.5	524 (N)
 02055	Retail Packaged B50, Must Order in Multiples of 10	1"	4" x 3"	15,586	46,758	4.5	524 (N)

Angled 1" Forged D-Ring



- Forged from C-1045 steel
- 1" diameter ring
- Forged bracket is 2-1/4" wide & 1/2" thick
- D-Rings are not approved for overhead use
- **Includes:** Weld on mounting bracket

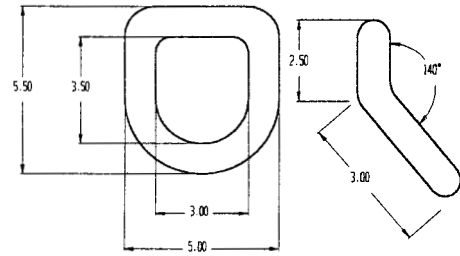

Part No.	Description	Ring DIA.	I.D. (H X W)	W.L.L. (lbs.)	Ultimate Breaking Strength (lbs.)	Wt. (lbs.)	Cat.
B5055	Forged D-Ring (55°) with Mounting Bracket	1"	3-1/2" x 3"	15,586	46,760	4.5	524 (N)

Recessed Rope Ring



B601

- Zinc plated
- Requires 3" dia. mounting hole in 3/8" or thicker material
- Do not use for lifting

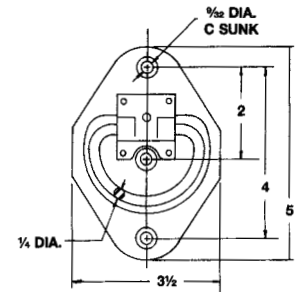

Part No.	Description	Hole Size for Bolt	W.L.L. (lbs.)*	Ultimate Breaking Strength (lbs.)	Wt. (lbs.)	Cat.
B601*	Recessed Rope Ring	7/16"	285	855	0.42	549 (N)
 02020*	Retail Packaged 4-Pack B601, Must Order in Multiples of 10	7/16"	285	855	0.42	549 (N)
B601U*	Recessed Rope Ring (.260 Holes Not Countersunk)	1/4"	285	855	0.42	549 (N)
7622BP	Zinc Plated Back Support Plate Used with B601, B601U, B701, B701SM, B20, B23, & B23SS	-	-	-	1.10	549 (N)

*All ratings shown are based on perpendicular loading under test conditions

Surface Mounted Rope Ring





B701SM

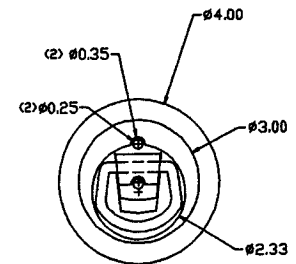

7622BP

- Zinc plated
- Requires 3" diameter mounting hole in 1/4" or thicker material
- Do not use for lifting



Part No.	Description	W.L.L. (lbs.)*	Ultimate Breaking Strength (lbs.)	Wt. (lbs.)	Cat.
B701SM*	Surface Mounted Rope Ring	265	795	0.26	549 (N)
 02025*	Retail Packaged 4-Pack B701SM, Must Order in Multiples of 10	265	795	0.26	549 (N)
7622BP	Zinc Plated Back Support Plate; Used with B601, B601U, B701, B701SM, B20, B23, & B23SS	-	-	1.10	549 (N)

*All ratings shown are based on perpendicular loading under test conditions



Products are Retail Packaged



Rope Rings

Surface Mounted or Recessed Rope Ring



- Zinc plated
- **Surface Mount:** Use plastic bezel with the recessed pan to form a surface mount rope ring
- **Recessed:** Use pan without bezel (requires 3" dia. mounting hole in 1/4" or thicker material)
- Do not use for lifting

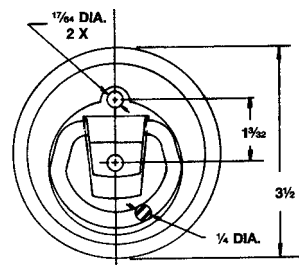

Part No.	Description	W.L.L. (lbs.)*	Ultimate Breaking Strength (lbs.)	Wt. (lbs.)	Cat.
B703	Recessed Rope Ring with Plastic Bezel	265	795	0.35	549 (N)

*All ratings shown are based on perpendicular loading under test conditions

Rope Ring with Plastic Surface Mount



- Zinc plated
- Plastic pan with 1/4" dia. steel ring
- Do not use for lifting

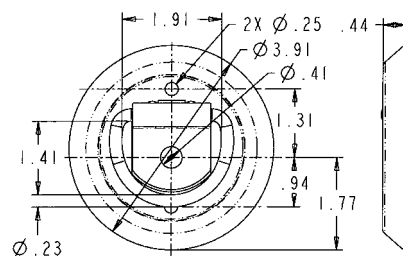

Part No.	Description	W.L.L. (lbs.)*	Ultimate Breaking Strength (lbs.)	Wt. (lbs.)	Cat.
B705	Surface Mounted Rope Ring	1,000	3,000	0.20	549 (N)

*All ratings shown are based on perpendicular loading under test conditions

Heavy duty Rope Ring



- Zinc plated
- 3/8" dia. steel ring
- Do not use for lifting
- **Includes:** Weld on mounting bracket

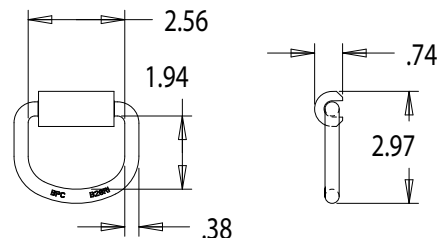

Part No.	Description	W.L.L. (lbs.)*	Ultimate Breaking Strength* (lbs.)	Wt. (lbs.)	Cat.
B28F	Heavy duty Rope Ring with Forged Weld-on Bracket	2,000	6,000	0.45	549 (N)

*All ratings shown are based on perpendicular loading under test conditions. Mounting material, material thickness, fastener type and method may reduce rating.

Rope Ring with Two Hole Bracket



B20



7622BP

- Zinc plated
- 1/4" dia. steel ring and formed steel clamp
- Do not use for lifting

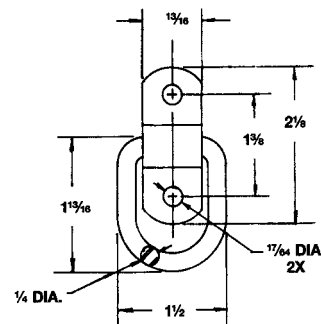

Part No.	Description	W.L.L. (lbs.)*	Ultimate Breaking Strength* (lbs.)	Wt. (lbs.)	Cat.
B20*	Rope Ring with Two Hole Mounting Bracket	800	2,400	0.12	549 (N)
02005*	Retail Packaged, 4-Pack B20, Must Order in Multiple of 10	800	2,400	0.12	549 (N)
7622BP	Zinc Plated Back Support Plate; Used with B601, B601U, B701, B701SM, B20, B23, & B23SS	-	-	1.10	549 (N)

*All ratings shown are based on perpendicular loading under test conditions. Mounting material, material thickness, fastener type and method may reduce rating.

Rope Ring with One Hole Clip



- 1/4" black zinc plated
- Do not use for lifting
- **Includes:** Clip

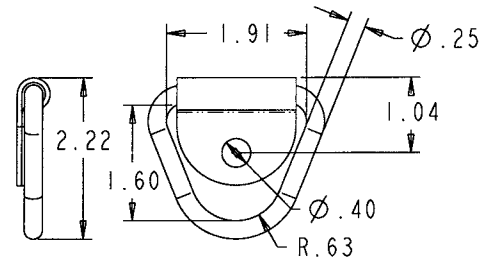

Part No.	Description	W.L.L. (lbs.)*	Ultimate Breaking Strength* (lbs.)	Wt. (lbs.)	Cat.
B21	Rope Ring with Clip	800	2,400	0.18	549 (N)

*All ratings shown are based on perpendicular loading under test conditions. Mounting material, material thickness, fastener type and method may reduce rating.

Light Duty Rope Ring with Bolt-on Bracket





B23

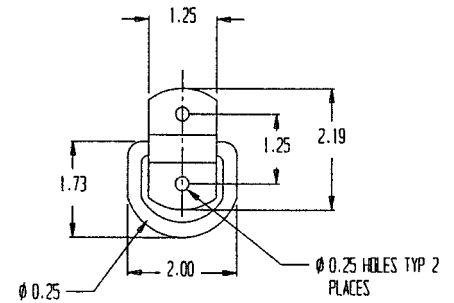

7622BP

- Zinc plated or stainless steel
- 1/4" dia. welded D-ring
- 1/4" dia. mounting holes
- Do not use for lifting
- Compares to Cargotrol® 36-40
- **Includes:** 14 Gauge steel clip



Part No.	Description	W.L.L. (lbs.)*	Ultimate Breaking Strength* (lbs.)	Wt. (lbs.)	Cat.
B23	Light-Duty Surface Mount Rope Ring	400	1,200	0.13	549 (N)
 02010	Retail Packaged 4-Pack of B23, Must Order in Multiple of 10	400	1,200	0.13	549 (N)
B23SS	Light-Duty Surface Mount Rope Ring, Stainless Steel	400	1,200	0.13	549 (N)
7622BP	Zinc Plated Back Support Plate; Used with B601, B601U, B701, B701SM, B20, B23, & B23SS	-	-	1.10	549 (N)

*All ratings shown are based on perpendicular loading under test conditions. Mounting material, material thickness, fastener type and method may reduce rating. Buyers Products is not authorized by nor affiliated with the manufacturer of Cargotrol® products.

Heavy Duty Rope Ring with Bolt-On Bracket



- Zinc plated
- 3/8" dia. forged rope ring
- Do not use for lifting
- **Includes:** Bolt-on bracket

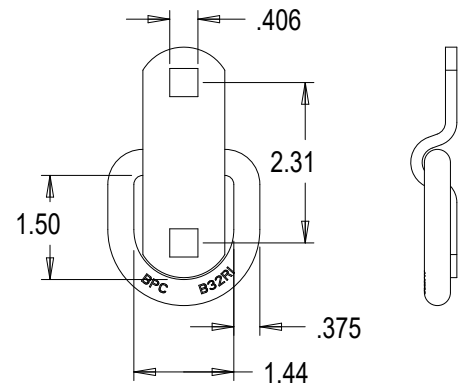

Part No.	Description	W.L.L. (lbs.)*	Ultimate Breaking Strength* (lbs.)	Wt. (lbs.)	Cat.
B32F	Surface Mounted Rope Ring with Bolt-On Bracket	2,000	6,000	0.42	549 (N)

*All ratings shown are based on perpendicular loading under test conditions. Mounting material, material thickness, fastener type and method may reduce rating.

Rope Rings & Chain Loop

Rope Ring with Integral Bracket



- Zinc plated
- Do not use for lifting
- **Includes:** Integral bracket

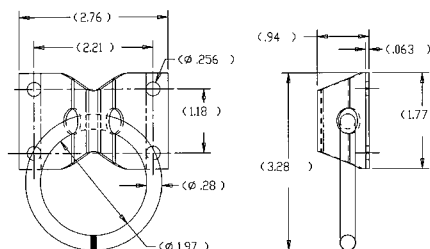

Part No.	Description	Wt. (lbs.)	Cat.
B33	Rope Ring with Integral Bracket	0.22	549 (N)

Heavy Duty Recessed Rotating Rope Ring



B901



901BP

- Fabricated recessed ring rotates 360°
- Designed to bolt to floor or weld to steel cross members.
- Do not use for lifting

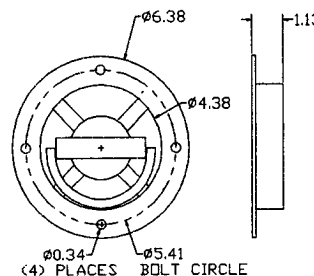

Part No.	Description	W.L.L. (lbs.)*	Ultimate Breaking Strength* (lbs.)	Wt. (lbs.)	Cat.
B901	Heavy duty Recessed Rotating Rope Ring	2,000	6,000	2.50	549 (N)
901BP	Zinc Plated Back Support Plate; used with B901	-	-	0.74	549 (N)

*All ratings shown are based on perpendicular loading under test conditions. Mounting material, material thickness, fastener type and method may reduce rating.

Heavy Duty Recessed Rope Ring



B801



B801A

- Zinc plated standard (B801 non-plated pan with plated ring available)
- Formed 1/8" steel pan houses a ductile iron ring
- 3-5/8" dia. hole with 7/8" clearance below surface is required
- Square mounting holes for use with 3/8-16 x 2-1/4" carriage bolts
- Hole spacing (on center): Vertical - 3-1/4" x Horizontal - 3"
- Do not use for lifting

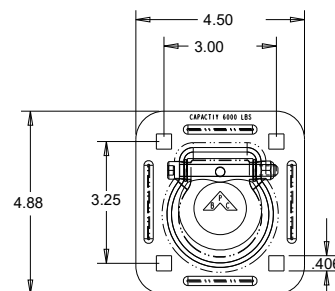

Part No.	Description	W.L.L. (lbs.)*	Ultimate Breaking Strength* (lbs.)	Wt. (lbs.)	Cat.
B801	Heavy duty Recessed Rope Ring (Non-Plated Weldable Pan with Ring)	2,000	6,000	1.25	549 (N)
B801A	Heavy duty Recessed Rope Ring	2,000	6,000	1.25	549 (N)
02030	Retail Packaged B801A, must Order in Multiple of 10	2,000	6,000	1.25	549 (N)
B801AK	Heavy duty Recessed Rope Ring Kit (contains B801A, 801BP, & mounting hardware)	2,000	6,000	2.50	549 (N)
801BP	Plain Back Support Plate; Used with B801A	-	-	0.92	549 (N)
801BPG	Galvanized Steel Back Support Plate; used with B801A	-	-	0.92	549 (N)

*All ratings shown are based on perpendicular loading under test conditions. Mounting material, material thickness, fastener type and method may reduce rating.

Cast Aluminum Chain Loop



- Cast aluminum, 1/2" dia.
- Width of opening is 2-1/10"
- Depth of opening is 1-3/4"
- .44" dia. mounting holes
- Do not use for lifting

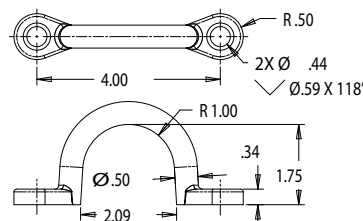

Part No.	Description	Wt. (lbs.)	Cat.
B2402AL	Aluminum Chain Loop	0.15	520 (N)

Threaded Eye Bolt



B56721

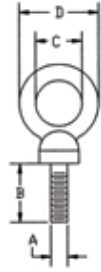

- Drop forged
- Heat treated eye bolt

Unthreaded Eye Bolt



B56734BLK



- Drop Forged
- No Threads

Part No.	Safe Load (lbs.)	Ult. Load (lbs.)	Thread Stocked	A	B	C	D	Wt. (lbs.)	Cat.
B56721	400	3,000	1/4 - 20	1/4"	1"	3/4"	13/16"	0.05	550 (N)
B56722	1,000	4,000	5/16 - 18	5/16"	1-1/8"	7/8"	1-1/2"	0.11	550 (N)
B56723	1,400	6,000	3/8 - 16	3/8"	1-1/4"	1"	1-21/32"	0.20	550 (N)
B56724	2,000	7,800	7/16 - 14	7/16"	1-3/8"	1-1/16"	1-15/16"	0.23	550 (N)
B56725	2,600	10,000	1/2 - 13	1/2"	1-1/2"	1-3/16"	2-1/16"	0.35	550 (N)
B56726	3,200	12,600	9/16 - 12	9/16"	1-5/8"	1-9/32"	2-13/32"	0.47	550 (N)
B56727	4,000	16,000	5/8 - 11	5/8"	1-3/4"	1-3/8"	2-1/2"	0.64	550 (N)
B56728	6,000	24,000	3/4 - 10	3/4"	2"	1-1/2"	2-13/16"	1.00	550 (N)
B56729	7,000	32,000	7/8 - 9	7/8"	2-1/4"	1-11/16"	3-1/4"	1.50	550 (N)
B56730	8,000	40,000	1 - 8	1"	2-1/2"	1-13/16"	3-9/16"	2.20	550 (N)
B56730C*	8,000	40,000	1 - 8	1"	2-1/2"	1-13/16"	3-9/16"	2.20	550 (N)
B56732	11,200	67,000	1-1/4 - 7	1-1/4"	3"	2-3/16"	4-7/16"	4.50	550 (N)
B56734	18,000	84,000	1-1/2 - 6	1-1/2"	3-1/2"	2-9/16"	5-1/2"	8.00	550 (N)
B56735	28,000	138,000	1-3/4 - 5	1-3/4"	3-3/4"	2-7/8"	6"	11.5	550 (N)
B56734BLK			No Thread	1-1/2"	3-1/2"	2-9/16"	5-1/2"	9.00	550 (N)

* Chrome plated

Galvanized Anchor Shackle



- Includes screw pin
- 2,000 lbs. W.L.L.

Part No.	Description	Wt. (lbs.)	Cat.
5480375	3/8" Galvanized Anchor Shackle with Screw Pin	0.3	524 (N)

Trailer Bed Chain Tie Down



- Provides floor flush anchor point
- 3/8" Grade 70
- 6,600 lbs. W.L.L.

Part No.	Description	Wt. (lbs.)	Cat.
1901006	Trailer Bed Chain Tie Down with 6,600 lbs. W.L.L.	3.25	548 (N)

Forged Load Binder



- Works with 3/8" hook, grade 43 chain, 16" lever, min. breaking strength 19,000 lbs., 5,400 W.L.L.
- Works with 5/16" hook, grade 70 chain, 16" lever, min. breaking strength 19,000 lbs. 4,700 W.L.L.

Part No.	Description	Wt. (lbs.)	Cat.
LB5638	5/16" - 3/8" Chain, Forged Load Binder	6.5	548 (N)

Ratcheting Load Binder



- Double-acting ratchet offers simple chain tightening
- Red painted finish
- Forged hooks & cast steel handle
- RLB5638: 23,100 lbs. min. breaking strength, 6,600 W.L.L.
- RLB3812: 33,000 lbs. min. breaking strength, 9,200 W.L.L.

Part No.	Description	Wt. (lbs.)	Cat.
RLB5638	5/16" - 3/8" Chain, Ratcheting Load Binder, 14.25" Handle	10.55	548 (N)
RLB3812	3/8" - 1/2" Chain, Ratcheting Load Binder, 14.25" Handle	14.55	548 (N)



Outriggers

7" Cast Steel Removable Outrigger



- Forged steel construction
- Brackets sold separately
- 7" x 14"

Part No.	Description	Capacity (lbs.)	Wt. (lbs.)	Cat.
NEW B23506	Removable Outrigger (Brackets Sold Separately)	6,500	7.0	520 (N)
B23505LH	Left Hand Outrigger Bracket; used with B23506	-	3.8	520 (N)
B23505RH	Right Hand Outrigger Bracket; used with B23506	-	3.8	520 (N)
66053	Snapper Pin, 5/16" x 2.75" (Sold Separately)	-	0.11	518 (N)

8" Forged Steel Outrigger



- Forged carbon steel
- Designed to allow for indexing at 90° angles
- 3 locking positions
- 8" x 12-1/2"
- **Includes:** Upper and lower mounting brackets

Part No.	Description	Capacity (lbs.)	Wt. (lbs.)	Cat.
B23515	Forged Steel Outrigger with Brackets	5,000	17.1	520 (N)

8-1/4" Ductile Iron Outrigger



- 100-70-03 cast ductile iron
- Increase trailer width 12" per side
- Brackets sold separately
- 8-1/4" x 12-1/4"

Part No.	Description	Capacity (lbs.)	Wt. (lbs.)	Cat.
B23510	Ductile Iron Outrigger (Brackets Sold Separately)	5,000	10.0	520 (N)
B2351001	Bracket, Welds to Flange of Beam; used with B23510 (2 Required)	-	0.75	520 (N)
B2351002	Bracket, Welds to Web of Beam; used with B23510 (2 Required)	-	1.75	520 (N)

Weld-On Trailer Winches

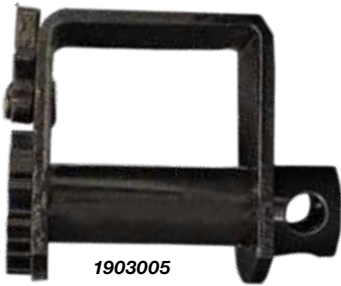

- All steel construction
- Ratchet style
- For use with 4" straps

Part No.	Description	Wt. (lbs.)	Cat.
1903005	Standard Weld-on 4" Winch, Right Hand	8.1	548 (N)
1903005LH	Standard Weld-on 4" Winch, Left Hand	8.1	548 (N)

Bolt-on And Sliding Trailer Winch



- All steel construction
- Ratchet style
- For use with 4" straps



1903040

- 72" Length track
- 1/4" Thick formed steel



Part No.	Description	Wt. (lbs.)	Cat.
1903020	Standard Bolt-on 4" Winch	9.1	548 (N)
1903030	Standard Sliding 4" Winch	10.5	548 (N)
1903035	Deep Storable Sliding 4" Winch	11.5	548 (N)
1903040	Sliding Winch Track, 1/4" x 72"	39.0	548 (N)

Lashing Winch

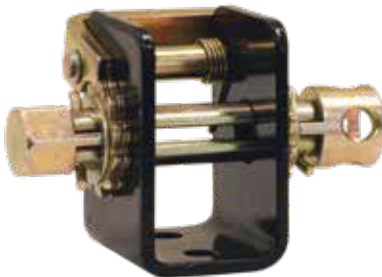

- For use with 2" straps
- Weld-on or bolt-on (2 pre-drilled mounting holes)
- Prybar & hex drive
- Cap.: 3,333 lbs. W.L.L. & 10,000 lbs. M.B.S.

Part No.	Description	Wt. (lbs.)	Cat.
 5482100	5-Ton Lashing Winch, 2"	4.0	548 (N)



Load Binder & Trailer Tie-Down Hardware

Combination Winch Bar

- Steel construction
- For use with steel trailer winches and load binders



Part No.	Description	Wt. (lbs.)	Cat.
1903065	Combination Winch Bar, 40" Long, Black	6.6	548 (N)
1903066	Combination Winch Bar, 40" Long, Chrome	6.6	548 (N)

Standard Winch Bar

- Steel construction
- For use with steel trailer winches



Part No.	Description	Wt. (lbs.)	Cat.
1903060	Standard Winch Bar, Black, 35" Long	5.3	548 (N)

4" Winch Strap



- For use with steel trailer winches

Part No.	Description	W.L.L. (lbs.)*	Wt. (lbs.)	Cat.
1903070	4" x 27' Winch Strap with Flat Hook, 15,000 lb. Capacity	5,000	4.6	548 (N)

Hand Winch



- Nylon strap: 1-1/2" x 26' (HW800S); 2" X 20' (HW2000S)
- Gear ratio: 4.4:1 (HW800S); 4.4:1 & 9.8:1 (HW2000S)
- 7" handle (HW800S); 9.84" handle (HW2000S)
- Cranks in & out under load, Winch free wheels
- Zinc plated

Part No.	Description	Wt. (lbs.)	Cat.
HW800S	Hand Winch, 800 lb. Capacity	4.97	548 (N)
HW2000S	Hand Winch, 2,000 lb. Capacity	11.08	548 (N)

3" Ratchet Straps



- 3" x 27' Ratchet Strap with Flat Hooks

Part No.	Description	W.L.L. (lbs.)	Ultimate Breaking Strength (lbs.)	Wt. (lbs.)	Cat.
RS132715F	3" x 27' Ratchet Strap with Flat Hooks	5,000	15,000	12.0	548 (N)

2" Ratchet Straps



- 2" X 27' ratchet strap with flat hooks

Part No.	Description	W.L.L. (lbs.)	Ultimate Breaking Strength (lbs.)	Wt. (lbs.)	Cat.
 01055	2" x 27' Ratchet Strap with Flat Hooks	3,300	10,000	5.6	548 (N)

2" Ratchet Straps with Soft Grip



- Soft grip rubber handle
- 2" X 27' ratchet straps with flat hooks or double J hooks

Part No.	Description	W.L.L. (lbs.)	Ultimate Breaking Strength (lbs.)	Wt. (lbs.)	Cat.
 RTD12271F	2" x 27' Ratchet Strap with Flat Hooks	3,300	10,000	5.6	548 (N)
 RTD12271J	2" x 27' Ratchet Strap with Double J Hooks	3,300	10,000	5.6	548 (N)

1" Ratchet Straps with Soft Grip



- Soft grip rubber handle and thumb release
- Vinyl coated hooks
- Must be ordered in multiples of 4/cut case box

Part No.	Description	W.L.L. (lbs.)	Ultimate Breaking Strength (lbs.)	Wt. (lbs.)	Cat.
 RTD211218	1" x 12' Ratchet Tie Downs (2-Pack)	600	1,800	2.53	548 (N)
 RTD411218	1" x 12' Ratchet Tie Downs (4-Pack)	600	1,800	5.44	548 (N)

1" Cambuckle Straps



- Quick lock cambuckles
- Vinyl coated hooks
- Must be ordered in multiples of 4/cut case box

Part No.	Description	W.L.L. (lbs.)	Ultimate Breaking Strength (lbs.)	Wt. (lbs.)	Cat.
 CBTD41612	1" x 6' Cambuckle Tie Downs (4-Pack)	400	1,200	4.00	548 (N)



E-Track

E-Track

- Adjustable anchor points
- 12-Gauge steel
- Gunmetal grey powder coat



1903110

Part No.	Description	Wt. (lbs.)	Cat.
1903050	E-Track 10' Sections, Steel with Holes	16.5	520 (N)
1903055	E-Track, 5' Sections, Steel with Holes	8.3	520 (N)
1903052	E-Track, 2' Sections, Steel with Holes	3.3	520 (N)
1903110	E-Track, Horizontal, 10' Sections, Aluminum without Holes	6.4	520 (N)

E-Track Curved J-Hook

- 1/2" x 4-1/4" I.D. Steel
- White powder coat finish
- Provides quick hook location



Part No.	Description	Wt. (lbs.)	Cat.
01120	E-Track J-Hook, 4-1/4" ID	0.89	520 (N)

E-Track J-Hook

- 3/8" x 2" I.D. Steel
- White powder coat finish
- Provides quick hook location



Part No.	Description	Wt. (lbs.)	Cat.
01130	E-Track J-Hook, 2" ID	0.50	520 (N)

E-Track Board Holder

- Holds 2" x 4" & 2" x 6" lumber
- Working load limit capacity depends on board or beam
- Zinc plated



Part No.	Description	Wt. (lbs.)	Cat.
01100	E-Track Board Holder (Holds 2x4 & 2x6 Lumber)	1.00	520 (N)

Swiveling E-Track Single Slot With Rope Ring

- Easy to install, bolt-on 360° Swiveling base
- Rotating base prevents tie-down straps from tangling
- Includes: 1 E-track rope ring



Part No.	Description	W.L.L. (lbs.)	Min. Breaking Strength (lbs.)	Wt. (lbs.)	Cat.
01091	E-Track Swivel Rope Ring, 360°	1,300	3,900	1.14	520 (N)

Super Track

- Anodized extruded aluminum
- (4) 46-1/2" tracks fit short and long pick-up beds
- (8) 1" ID tie rings can be positioned every 2"



Part No.	Description	W.L.L. (lbs.)	Min. Breaking Strength (lbs.)	Wt. (lbs.)	Cat.
ST93	Clear Anodized Rails & Adjust. Tie Rings	400	-	7.85	548 (N)
LR1	1" Load Ring for Super Track, Only	1,000	3,000	0.2	548 (N)

2" E-Track Cambuckle Strap

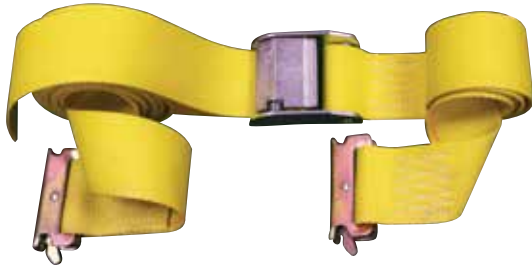

- For use with E-Track
- Cambuckle feature lets you adjust tension and strap length.

Part No.	Description	W.L.L. (lbs.)	Min. Breaking Strength (lbs.)	Wt. (lbs.)	Cat.
01070	2" x 12' Cambuckle Strap with Fitting	915	2,745	2.0	520 (N)

2" E-Track Ratchet Straps



- For use with E-Track
- Ratchet provides a strong, sturdy hold.

Part No.	Description	W.L.L. (lbs.)	Min. Breaking Strength (lbs.)	Wt. (lbs.)	Cat.
01075	2" x 12' Ratchet Strap with Fitting	1,467	4,400	2.2	520 (N)
01076	2" x 16' Ratchet Strap with Fitting	1,467	4,400	2.3	520 (N)
01077	2" x 20' Ratchet Strap with Fitting	1,467	4,400	2.4	520 (N)

2" E-Track Rope Tie Off



- For use with E-Track
- Provides a powerful and flexible tie-off point

Part No.	Description	W.L.L. (lbs.)	Min. Breaking Strength (lbs.)	Wt. (lbs.)	Cat.
01080	2" x 6" Rope Ring Tie Down Strap with Fitting	1,000	3,000	0.3	520 (N)

E-Track Rope Ring



- 1-5/16" I.D. Ring
- Spring action security latch
- Zinc plated

Part No.	Description	W.L.L. (lbs.)	Min. Breaking Strength (lbs.)	Wt. (lbs.)	Cat.
01090	Rope Ring with E-Track Fitting	2,000	6,000	0.52	520 (N)

Straps & Tie Downs

2" Retractable Tie-Down



5480010



5480011

- 2" x 10' Strap with S-Hooks or E-track fittings
- Heavy duty bolt-on design
- Works great with ladder racks, ATV's, motorcycles, boats, etc.
- Spring retracting spool
- Soft grip rubber handle

Part No.	Description	W.L.L. (lbs.)	Ultimate Breaking Strength (lbs.)	Wt. (lbs.)	Cat.
5480010	2" x 10' Retractable Tie-Down, Used with S-Hooks	1,000	3,000	4.20	548 (N)
5480011	2" x 10' Retractable Tie-Down, Used with E-Track Systems	1,000	3,000	4.50	520 (N)

1-1/2" Ratchet Tie-Down for Square Tube Ladder Racks



- 1-1/2" x 7' strap with double J-Hook
- Ladder rack ratchet tie down
- Structural steel mounting angle
- Fits racks with square and rectangular tubing
- Zinc plated with black powder coat finish

Part No.	Description	W.L.L. (lbs.)	Ultimate Breaking Strength (lbs.)	Wt. (lbs.)	Cat.
5480005	1-1/2" x 7' Strap with Double J-Hook, Angle Mount, (2-Pack)	500	1,500	8.00	548 (N)
3028819	Replacement Strap/Prybar (used with 5480005 & 5480007)	-	-	1.25	548 (N)

1-1/2" Ratchet Tie-Down for Round Tube Ladder Racks



- 1-1/2" x 7' strap with double J-Hook
- Ladder rack ratchet tie down
- Rolled steel bracket fits ladder racks with popular 1-7/8" - 2" OD round tubing
- Zinc plated with black powder coat finish
- 2 per pack

Part No.	Description	W.L.L. (lbs.)	Ultimate Breaking Strength (lbs.)	Wt. (lbs.)	Cat.
5480007	1-1/2" x 7' Strap with Double J-Hook, Tube Mount, (2-Pack)	500	1,500	7.00	548 (N)
3028819	Replacement Strap/Prybar (used with 5480005 & 5480007)	-	-	1.25	548 (N)

17" Foam Quick Tie



- Multi-purpose
- High density steel alloy core with foam coating
- Foam cover prevents scratching

Part No.	Description	W.L.L. (lbs.)	Ultimate Breaking Strength (lbs.)	Wt. (lbs.)	Cat.
5480417	17" Foam Quick Tie, Red, 4-Pack	-	-	0.39	548 (N)

TRUCK & TRAILER HARDWARE

Buyers Truck & Trailer Hardware has what you need to complete your truck or trailer.

U-BOLTS AND TIE DOWN RODS	H2
STAKE BODY HARDWARE	H3
NEW Bumper Vise Mount	H5
NEW Forged Stake Pocket D-Ring	H6
NEW Stake Pocket Spare Tire Carrier	H6
TRUCK STEPS	H7
GRAB HANDLES, CORNER IRONS, & FUEL FILL DISHES	H11
T-HANDLE & PADDLE LATCHES	H12
LOCK CYLINDERS	H14
SPRING LATCHES	H15
HOOD CATCHES & LATCHES	H17
HINGES	H20
DOOR CHECKS AND PROPS	H26
NEW Gas Springs	H27
DOOR LOCKS AND HANDLES	H28
SECURITY HASPS & LEVER NUTS	H29
PINS	H30
NEW 1-1/2" Zinc Plated Snapper Pins	H30
END RODS & YOKE ENDS	H32
RUBBER BUMPERS	H35
SUSPENSION KITS	H38
TAILGATE CYLINDERS	H39
AIR VALVES	H40
DUMP BODY HARDWARE	H41
TAILGATE LATCHES & LEVERS	H43
AIR FITTINGS & TUBES	H45



U-Bolts Kits

Square Bend U-Bolt Tie Downs Kit



- Four square bend 5/8" U-Bolts
- Eight 5/8" hex nuts
- Eight 5/8" split lock washers
- Four 1/2" thick tie bars
- Grade 5 equivalent

*U-Bolt kits are shipped individually boxed. Other diameter and length U-Bolts are available by special order

Part No.	Length	Wt. (lbs.)	Cat.
UB623512	12"	13.2 (kit)	760 (Y)
UB623514	14"	14.2 (kit)	760 (Y)
UB623516	16"	15.5 (kit)	760 (Y)
UB623518	18"	16.5 (kit)	760 (Y)
UB623520	20"	18.0 (kit)	760 (Y)
UB623522	22"	18.7 (kit)	760 (Y)
UB623524	24"	20.0 (kit)	760 (Y)

Body Tie-Down Rod



- Grade 5 material
- 4" of 5/8"-11 N.C. thread on each end
- Eight hex nuts 5/8"-11 thread
- Eight split lock washers 5/8" I.D.
- Plain finish
- **Hardware bag TR6211588** (contains 8 5/8" Gr. 5 Hex Nuts and 8 5/8 split lock washers) **not included (must purchase separately)**

Part No.	Length	Wt. (lbs.)	Cat.
TR6211512Z (ZINC)	12"	0.88	760 (Y)
TR6211514	14"	1.00	760 (Y)
TR6211516	16"	1.12	760 (Y)
TR6211518	18"	1.24	760 (Y)
TR6211520	20"	1.36	760 (Y)
TR6211522	22"	1.48	760 (Y)
TR6211524	24"	1.60	760 (Y)
TR6211588* (not shown)	Hdw. Kit for Tie-Down Rod	1.55	295 (N)

* Includes (8) 5/8-11 Grade 5 Hex Nuts & (8) 5/8" split lock washers

Spring Cushion U-Bolt Kit



- (4) 16" square bend zinc plated 5/8" u-bolts
- (4) forged tie bars, zinc plated
- (8) spring/fasteners, zinc plated

Part No.	Description	Wt. (lbs.)	Cat.
3008086	Spring Cushioned Mounting Kit	17	531 (Y)

Tie Bar



Part No.	Length	Holes C - C	Frame Size	Holes	Thickness	Width	Wt. (lbs.)	Cat.
B2162E	5-1/4"	3-3/4"	3"	21/32"	1/2"	1-1/2"	1.0	760 (Y)
B2162H	6-1/2"	4-1/2"	3-3/4"	21/32"	1/2"	1-1/2"	1.0	760 (Y)
B2162N	5-1/2"	4-1/4"	3-1/2"	25/32"	1/2"	1-1/2"	1.0	760 (Y)

Forged Tie Bar

- Forged



Part No.	Length	Holes C - C	Frame Size	Holes	Thick-ness	Width	Wt. (lbs.)	Cat.
B2162FF	5-3/4"	4-1/4"	3-1/2"	21/32"	1/2"	1-1/4"	0.95	760 (Y)

Straight Side Security Latch Set



- Complete set of 4 pieces is shown
- Order by set or individual pieces
- Available plain, zinc plated or weld style
- Right or left hand, dependent on assembly

Part No.	Description	Wt. (lbs.)	Cat.
B2588B	Straight Side Security Latch Set, Plain	1.5	526 (N)
B2588BZ	Straight Side Security Latch Set, Zinc	1.5	526 (N)
 06025	Straight Side Security Latch Set, Zinc	1.5	526 (N)
B2588W	Straight Side Security Latch Set, Weld-On (No Holes)	1.5	526 (N)

Corner Security Latch Set



- Complete set of 4 pieces is shown
- Order by set or individual pieces
- Available plain, zinc plated or weld style
- Right or left hand, dependent on assembly

Part No.	Description	Wt. (lbs.)	Cat.
B2589B	Corner Security Latch Set, Plain	1.5	526 (N)
B2589BZ	Corner Security Latch Set, Zinc	1.5	526 (N)
 06030	Corner Security Latch Set, Zinc	1.5	526 (N)
B2589W	Corner Security Latch Set, Weld-On (No Holes)	1.5	526 (N)

Replacement Parts			
Part No.	Description	Wt. (lbs.)	Cat.
1	Latch Bar	0.51	526 (N)
2	Bearing Plate	0.23	526 (N)
3	Bearing Cap	0.26	526 (N)
4	Corner Plate	0.61	526 (N)
5	Side Plate	0.42	526 (N)

To order zinc plated or welded unit components add Z or W suffix to part number. For example: 2W is a weld-on bearing plate.

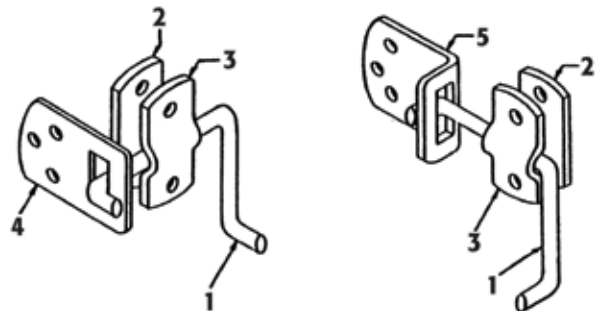

Stake Body Spring Latch



B2590RH

- Spring loaded handle
- Zinc plated bolt & housing; stainless steel spring

Part No.	Description	Wt. (lbs.)	Cat.
B2590LH	1/2" Spring Latch Assy. Left Hand	0.85	510 (N)
B2590RH	1/2" Spring Latch Assy. Right Hand	0.85	510 (N)
B2590KZ	90 Degree Keeper for B2590LH, Right Hand	0.85	510 (N)



Products are Retail Packaged



Stake Body Hardware

Straight Stake Rack Connector Set



- 7" overall length, 11/32" holes
- Formed from 2-1/2" x 3/16" stock
- One set consists of 4 pieces: one L.H. pair and one R.H. pair

Part No.	Description	Wt. (lbs.)	Cat.
B2585B	Straight Stake Rack Connector Set	2.0	526 (N)
B2585BZ	Straight Stake Rack Connector Set, Zinc	2.0	526 (N)
06015	Straight Stake Rack Connector Set, Zinc	2.0	526 (N)

Corner Stake Rack Connector Set



- 3-5/8" length to inside of angle, 11/32" holes
- Formed from 2-1/2" x 3/16" stock
- One set consists of 4 pieces: one L.H. pair and one R.H. pair

Part No.	Description	Wt. (lbs.)	Cat.
B2591B	Comer Stake Connector Set	2.0	526 (N)
B2591BZ	Corner Stake Rack Connector Set, Zinc	2.0	526 (N)
06020	Corner Stake Rack Connector Set, Zinc	2.0	526 (N)

Spring Latch



- Use on tailgates, stake posts, and compartment doors & drawers
- Zinc finish hook & spring

Part No.	Description	Wt. (lbs.)	Cat.
B2597	Spring Latch, Zinc Plated; 10" L x .75" W	0.25	510 (N)

Liner Slat



- Slats are made from 16 gauge steel
- Long edges are rolled over, and corners are radiused for safety

Part No.	Description	Wt. (lbs.)	Cat.
LS166545	Liner Slat; 44.62" L x 6.5" W	5.5	526 (N)
LS166548	Liner Slat; 47.25" L x 6.5" W	6.0	526 (N)
LS166554	Liner Slat; 53.25" L x 6.5" W	6.5	526 (N)
LS166572	Liner Slat; 71.25" L x 6.5" W	9.0	526 (N)
LS166590	Liner Slat; 90" L x 6.5" W	11.5	526 (N)
LS1665120	Liner Slat; 120" L x 6.5" W	15.0	526 (N)
LS1665144	Liner Slat; 144" L x 6.5" W	18.0	526 (N)

Stake Assembly



- Two piece stakes with welded reinforcements
- Made of 14 gauge steel
- Pocket size, 3"W x 4-3/4"D

Part No.	Description	Wt. (lbs.)	Cat.
SA1447WDNH	Stake Assembly; 47" T x 4.5" W	7.5	526 (N)
SA1454WDNH	Stake Assembly; 54" T x 4.5" W	8.5	526 (N)

Straight Bolt-On Stake Pocket



- Straight pocket for easy in/out of stake posts
- Made of 14 gauge steel
- Paintable

Part No.	Description	Inside Dimension	Depth	Wt. (lbs.)	Cat.
B2373G*	Straight 1/8" Steel Bolt-On Stake Pocket	3" x 1-1/2"	2-1/2"	0.7	515 (N)

*Can be used to secure Buyers stake assemblies

Tapered Bolt-On Stake Pocket



- Tapered slightly for tight fit of upright stake posts
- Made of 14 gauge steel
- Paintable

Part No.	Description	Top	Bottom	Depth	Wt. (lbs.)	Cat.
B2374G	Tapered 1/8" Steel Bolt-On Stake Pocket	3" x 1-1/2"	2-7/8" x 1-1/2"	2-1/2"	0.7	515 (N)
 06010	Tapered 1/8" Steel Bolt-On Stake Pocket	3" x 1-1/2"	2-7/8" x 1-1/2"	2-1/2"	0.7	515 (N)
B2374GZ	Tapered 1/8" Steel Bolt-On Stake Pocket, Zinc	3" x 1-1/2"	2-7/8" x 1-1/2"	2-1/2"	0.7	520 (N)

Straight Weld-On Stake Pocket



- Ideal for securing stake body wall assemblies on the straight-side of a stake body flatbed or trailer
- Made of 14 gauge steel
- Pocket size, 3"W x 4-3/4"D

Part No.	Description	Inside Dimension	Depth	Wt. (lbs.)	Cat.
B2373C	Straight 1/4" Steel Weld-On Stake Pocket	3-1/2" x 1-3/4"	4"	1.9	515 (N)
B2373J*	Straight 1/4" Steel Weld-On Stake Pocket	3" x 1-1/2"	3"	2.0	515 (N)
B2373K*	Straight 1/4" Steel Weld-On Stake Pocket	3" x 1-1/2"	4"	2.5	515 (N)
B2373R	Straight 7/32" Steel Weld-On Stake Pocket	3-1/2" x 1-1/2"	3"	1.3	515 (N)
B2373W*	Straight 1/8" Steel Weld-On Stake Pocket	3" x 1-1/2"	2-1/2"	0.48	515 (N)
 06005	Straight 1/8" Steel Weld-On Stake Pocket	3" x 1-1/2"	2-1/2"	0.48	515 (N)

*Can be used to secure Buyers stake assemblies

Bumper Vise Mount



- Easily bolts to a service or utility truck bumper
- Pre-drilled for versatile height adjustment and for attaching vise
- Black or white powder coat finish
- Fits Wilton® vise models AW35, 3505, 400S, AW45, 4505, C-0, C-2 and 2040

Part No.	Description	Wt. (lbs.)	Cat.
 5201015	Bumper Vise Mount, 12.25" L x 7.625" W x 9" H, Black	12.5	512 (N)
5201017	Bumper Vise Mount, 12.25" L x 7.625" W x 9" H, White	12.5	512 (N)



Stake Body Hardware

Forged Stake Pocket D-Ring

- Provides convenient D-Ring tie down where needed
- Fits common flush and outside stake pockets
- 1/2" hitch pin with cotter
- D-Rings are not approved for overhead use



B38SP application



B38SP



B32SPZ



B28SP

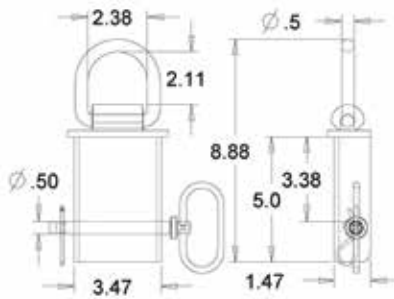

B38SP

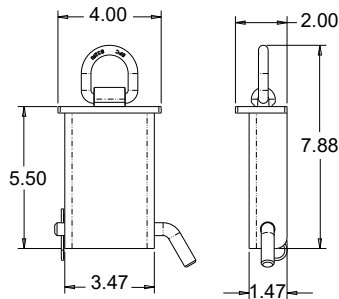

B32SP / B32SPZ

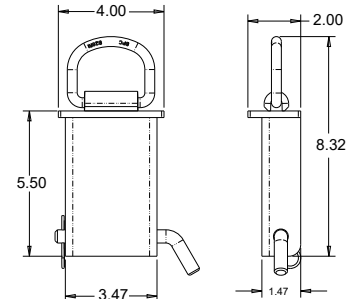

B28SP / B28SPZ

Part No.	Ring DIA.	I.D. (H X W)	Finish	Wt. (lbs.)	Cat.
B38SP	1/2"	2-1/2" x 2-3/8"	Black Powder Coated	3.38	524 (N)
B28SP	3/8"	2" x 2-1/2"	Black Powder Coated	3.22	524 (N)
B28SPZ	3/8"	2" x 2-1/2"	Zinc Plated	3.22	524 (N)
B32SP	3/8"	1.44" x 1.50"	Black Powder-Coated	2.82	524 (N)
B32SPZ	3/8"	1.44" x 1.50"	Zinc Plated	3.22	524 (N)

Stake Pocket Spare Tire Carrier

- Provides a removable spare tire mount on stake body trucks and trailers
- Fits wheels with the following bolt patterns: 5 on 4.5, 5 on 5, 6 on 5.5, and 8 on 6.5
- Fits most standard stake pockets
- Black powder coat finish
- Installation hardware included

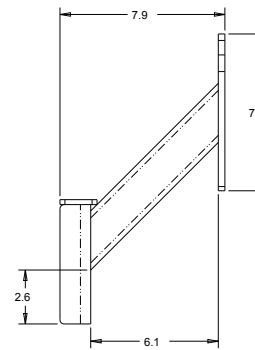
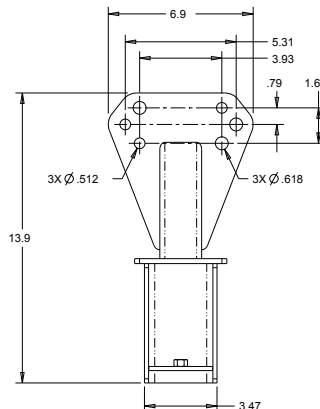

Part No.	Description	Wt. (lbs.)	Cat.
5201012	Stake Pocket Spare Tire Carrier	9.20	520 (N)

Folding Foot/Grab Step



- Investment cast
- Plain, zinc plated, black E-coat, or stainless steel finish available

Part No.	Finish / Material	Wt. (lbs.)	Cat.
B2797BPC	Black E-Coat Finish	1.25	523 (N)
B2797SS	Stainless Steel Finish	1.25	523 (N)
B2797Z	Zinc Coated	1.25	523 (N)

Large Folding Step



- Chrome plated, die cast construction for durability
- Stainless steel springs retain step firmly in opened or closed position
- Conforms to NFPA specifications
- 7-1/4" x 6-3/4" step platform

Part No.	Description	Wt. (lbs.)	Cat.
FS2797CH	Heavy Duty Cast Folding Step	5.68	523 (N)

Heavy Duty Folding Foot/Grab Step



- Die cast and stainless steel construction
- Stainless Steel, Chromed Stainless or zinc finish available
- Stainless steel springs retain step firmly in opened or closed position
- Conforms to NFPA specifications
- 5-1/3" x 6-1/2" step platform

Part No.	Description	Wt. (lbs.)	Cat.
5236585	Stainless Steel With Polished Chrome Finish	3.50	523 (N)
5236586	Cast with Zinc Finish	3.50	523 (N)
5236587	Polished Stainless Steel	3.50	523 (N)

Breakaway Truck Step



- Folds up for transport for added ground clearance on low step bumpers
- Folds forward or backwards to prevent damage if impacted
- Cast brass mounting bracket
- Galvanized steel step grip
- Stainless steel pivot shafts, springs and fasteners

Part No.	Description	Wt. (lbs.)	Cat.
5230710	Step, Breakaway, 7" T x 10" W x 4" D	10.0	523 (N)



Steps, Anti-Skid Tape, Retractable Steps & Cable Steps

Die Cast Weld-On Truck Step



- Die cast aluminum or steel construction
- Reversible for flat top or side guard application
- 7-3/4" L x 4-1/8" W x 1-1/2" T

Part No.	Description	Wt. (lbs.)	Cat.
B2744A	Weld-On Cast Aluminum Step, Reversible	1.50	523 (N)
B2744S	Weld-On Cast Steel Step, Reversible	3.20	523 (N)

Perforated Metal Channel Truck Step Grip



- Designed to help meet OSHA requirements
- Stocked in convenient 48" length
- 13 gauge hot rolled steel

Part No.	Description	Wt. (lbs.)	Cat.
SG1501048	3 Row Ladder Rung	3.80	523 (N)

Cable Truck Step



- 1-1/4" galvanized wire cable
- Cable welded to 1-1/2" pipe sleeve ends
- 1-3/8" deep perforated anti-slip metal grip step or 4-3/4" diamond deck-span deep step
- Black powder coat finish

Part No.	Description	Wt. (lbs.)	Cat.
5230912	Cable Step, 9" T x 12" W x 1-3/8" D, Black	4.50	523 (N)
5231212	Cable Step, 12" T x 12" W x 1-3/8" D, Black	8.98	523 (N)
5231512	Cable Step, 15" T x 12" W x 1-3/8" D, Black	9.18	523 (N)
5232417	2-Rung Cable Step, 24" T x 17.5" W x 3" D, Black	20.86	523 (N)

Deep Cable Truck Step



- 1-1/4" galvanized wire cable
- Cable welded to 1-1/2" pipe sleeve ends
- 1-3/8" deep perforated anti-slip metal grip step or 4-3/4" diamond deck-span deep step
- Black powder coat finish

Part No.	Description	Wt. (lbs.)	Cat.
NEW 5230926	Cable Step, 9" T x 26" W x 4.75" D, Black	17.0	523 (N)
5230915	Cable Step, 9" T x 15" W x 4.75" D, Black	8.80	523 (N)
5231515	Cable Step, 15" T x 15" W x 4.75" D, Black	11.8	523 (N)

Anti-Skid Tape Roll



- Black medium "46" grit surface improves traction and safety
- Ideal for bumpers, steps, walkways or anywhere foot traffic can be hazardous
- Each roll is individually boxed
- Helps meet OSHA & ADA requirements
- Resistant to detergents & solvents
- Custom sizes available
- Easy to apply simply peel & stick

Part No.	Description	Wt. (lbs.)	Cat.
AST60	Antiskid Tape, Self-Adhesive, 2" x 60' Roll	3.00	523 (N)
AST460	Antiskid Tape, Self-Adhesive, 4" x 60' Roll	4.50	523 (N)
AST660	Antiskid Tape, Self-Adhesive, 6" x 60' Roll	7.50	523 (N)

Anti-Skid Tape Sheets



- Black medium "46" grit surface improves traction & safety
- Easy to apply simply peel & stick
- Ideal for bumpers, steps, walkways or anywhere foot traffic can be hazardous
- Helps meet OSHA & ADA requirements
- Resistant to detergents & solvents
- Radiused corners for convenience & finished look
- Fifty precut 6" x 24" sheets per box
- Easy to apply, simply peel & stick

Part No.	Description	Wt. (lbs.)	Cat.
AST624	Anti-skid Tape, Self-Adhesive, 6" x 24" Sheets (50 per box)	13.0	523 (N)

Flexible Rubber Step



- Belted rubber, galvanized step
- Powder coated mounting bracket, weld-on or bolt-on
- Flexible & durable to resist damage from low objects & off road impact
- Zinc hardware included
- Common on mechanics trucks with low work shelf bumpers

Part No.	Description	Wt. (lbs.)	Cat.
5231112	Flexible Rubber Step, 12"W x 11"T	11.0	523 (N)
5231130	Flexible Rubber Step, 30"W x 11"T	22.0	523 (N)

Diamond Deck-Span Tread



- 12 Gauge steel
- Plain or galvanized
- 4.75" x 12"

Part No.	Description	Wt. (lbs.)	Cat.
3012035	Diamond Deck-Span Tread, Galvanized Steel	4.35	523 (N)
3013531	Diamond Deck-Span Tread, Plain Steel	4.35	523 (N)

Multi-Rung Steel Truck Step

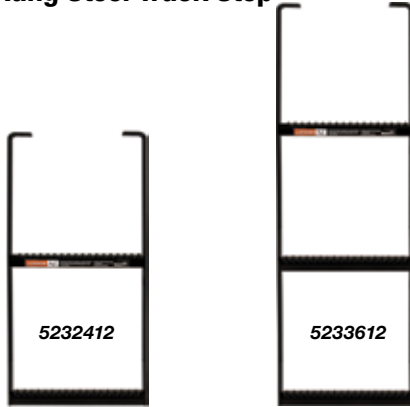

- 2" deep perforated anti-slip metal grip step
- 1/4" x 2" steel bar
- Black powder coat finish
- Bolt-on or weld-on

Part No.	Description	Wt. (lbs.)	Cat.
5232412	2-Rung Steel Step, Black Power Coated, 12.5"W x 24"H	9.00	523 (N)
5233612	3-Rung Steel Step, Black Power Coated, 12.5"W x 36"H	18.5	523 (N)

Retractable Truck Step



- Nonslip treads
- Compact storage - horizontal storage avoids interference with toolboxes, reservoirs, etc.
- Structural steel frame
- Bolt-on or weld-on

Part No.	Description	Wt. (lbs.)	Cat.
5232000	Retractable Truck Step, 2-Rung Black, 19.63"W x 25.5"H	21.2	523 (N)
5232001	Retractable Truck Step, 2-Rung Stainless Steel, 19.63"W x 25.5"H	21.2	523 (N)
NEW 5232000YEL	Retractable Truck Step, 2-Rung Yellow, 19.63"W x 25.5"H	21.2	523 (N)
5233000	Retractable Truck Step, 3-Rung Black, 19.63"W x 30.25"H	24.9	523 (N)
5233001	Retractable Truck Step, 3-Rung Stainless Steel, 19.63"W x 30.25"H	24.9	523 (N)
NEW 5233000YEL	Retractable Truck Step, 3-Rung Yellow, 19.63"W x 30.25"H	24.9	523 (N)

Polymer Step



- UV stable hi-density polyethylene
- Built-in handle provides easy lifting
- Stackable for storage/shipment
- Non-skid step surface
- Lightweight

Part No.	Description	Wt. (lbs.)	Cat.
3013658	Polymer Utility Step, Black, 24" L x 21" W x 16" T	14.60	523 (N)



Retractable Steps

Retractable One-Rung Truck Step



- Nonslip treads
- Black powder coat finish

Part No.	Description	Wt. (lbs.)	Cat.
RS1	Retractable Truck Step, 1 Rung, Black, 17.375"W x 15"H	19.0	523 (N)

Retractable Two-Rung Truck Step



- Nonslip treads
- Available in stainless steel or durable black white or yellow powder coat finish
- Stainless steel is bead blasted

Part No.	Description	Wt. (lbs.)	Cat.
RS2	Retractable Truck Step, 2 Rungs, Black, 17.375"W x 30.25"H	23.0	523 (N)
RS2SS	Retractable Truck Step, 2 Rungs, Stainless Steel, 17.375"W x 30.25"H	23.0	523 (N)
RS2W	Retractable Truck Step, 2 Rungs, White, 17.375"W x 30.25"H	23.0	523 (N)
RS2Y	Retractable Truck Step, 2 Rungs, Yellow, 17.375"W x 30.25"H	23.0	523 (N)

Retractable Three-Rung Truck Step



- Nonslip treads
- Available in stainless steel or durable black white or yellow powder coat finish
- Stainless steel is bead blasted

Part No.	Description	Wt. (lbs.)	Cat.
RS3	Retractable Truck Step, 3 Rungs, Black, 17.375"W x 35"H	25.0	523 (N)
RS3SS	Retractable Truck Step, 3 Rungs, Stainless Steel, 17.375"W x 35"H	25.0	523 (N)
RS3Y	Retractable Truck Step, 3 Rungs, Yellow, 17.375"W x 35"H	25.0	523 (N)

Poly-Coated Grab Handle



- Pop-out cover (hidden bolt) design

Part No.	Description	Wt. (lbs.)	Cat.
B239911P	10-13/16" Poly Coated Steel Grab Handle	0.55	516 (N)

Solid Aluminum Grab Handle



- Flat
- Bright anodized finish

Part No.	Description	Wt. (lbs.)	Cat.
B239916AL	16" Solid Aluminum Grab Handle, Flat	0.55	516 (N)

Solid Aluminum Round Grab Handle



- Round
- Bright anodized finish

B239918AL

Part No.	Description	Wt. (lbs.)	Cat.
B239914AL	13" Solid Aluminum Grab Handle, Round, 1/2" dia.	0.45	516 (N)

NEW 3039855	16" Solid Aluminum Grab Handle, Round, 5/8" dia.	0.50	516 (N)
--------------------	--	------	---------

B239918AL	18" Solid Aluminum Grab Handle, Round, 5/8" dia.	0.50	516 (N)
------------------	--	------	---------

Chrome Plated Solid Steel Grab Handle



- Chrome finish

B239918C

Part No.	Description	Wt. (lbs.)	Cat.
B2399BC	11-1/2" Chrome Finish Tubular Steel Grab Handle, 5/8" dia.	0.40	516 (N)

B239918C	13-1/4" Solid Steel Chrome Plated Grab Handle, 1/2" dia.	0.75	516 (N)
-----------------	--	------	---------

B239920C	16" Solid Steel Chrome Plated Grab Handle, 1/2" dia.	1.00	516 (N)
-----------------	--	------	---------

B239936C	36" Solid Steel Chrome Plated Grab Handle, 5/8" dia.	3.83	516 (N)
-----------------	--	------	---------

Steel Forged Grab Handle



B23399A

Part No.	Description	Wt. (lbs.)	Cat.
B2399A	9-1/2" Forged Grab Handle, 5/8" dia.	0.98	516 (N)

B2399B	11-1/2" Forged Grab Handle, 5/8" dia.	1.13	516 (N)
---------------	---------------------------------------	------	---------

B2399C	13-1/2" Forged Grab Handle, 5/8" dia.	1.28	516 (N)
---------------	---------------------------------------	------	---------

B2399D	15-3/8" Forged Grab Handle, 5/8" dia.	1.44	516 (N)
---------------	---------------------------------------	------	---------

B2399W	13-1/4" Forged Weld-On Grab Handle, 1/2" dia.	0.79	516 (N)
---------------	---	------	---------

Chrome Plated Die-Cast Grab Handle



Part No.	Description	Wt. (lbs.)	Cat.
B2399B6C	5-15/16" Die-Cast Grab Handle	0.75	516 (N)

Chrome Plated Die-Cast Zinc Alloy Grab Handle



Part No.	Description	Wt. (lbs.)	Cat.
B2399B2C	8-1/4" Die-Cast Grab Handle	0.75	516 (N)

Chest Handle



- .055 CRS plate
- Zinc plated
- 4" width x 2.75" height

Part No.	Description	Wt. (lbs.)	Cat.
B2344	Zinc Chest Handle	0.40	520 (N)

Corner Iron



B2487B

- Drop forged
- Available in two sizes
- Reinforces box van & enclosed trailer body corners

Part No.	Description	Wt. (lbs.)	Cat.
B2487B	Corner Iron 8" x 6" x 1-1/2" wide	2.70	520 (N)

B2485AA	Corner Iron 12" x 12" x 1-1/2" wide	4.50	520 (N)
----------------	-------------------------------------	------	---------

Fuel Fill Dish



FFD625SS

- Stainless steel
- Universal fit
- 6-1/4" Dia.
- 5-1/2" Bolt centers

Part No.	Description	Wt. (lbs.)	Cat.
FFD625SS	Fuel Fill Dish, Stainless Steel, 42°	1.00	520 (N)

FFD626SS	Fuel Fill Dish, Stainless Steel, 21°	1.00	520 (N)
-----------------	--------------------------------------	------	---------



T-Handle & Paddle Latches

Die Cast Compression Latch



- Powder coated die cast housing
- Chrome handle
- Locking chrome shank
- Cam action roller engagement
- Includes 1/2" gasket, cylinder and keys
- Adjustable cam from .850" to 1.320" (No tools required for adjustment)

***Replacement for Buyers boxes using L8816 and L3890RLS latch**

Part No.	Description	Face Dims. (HxW)	Wt. (lbs.)	Cat.
LL9000	Single Point, Compression Latch with Blind Studs	6" x 5.88"	2.04	510 (N)
LL90003	3-Point, Compression Latch with Blind Studs	6" x 5.88"	2.04	510 (N)

Standard Size Flush Mount T-Handle Latches



L8815

L8816

L8855

L8855

L8825

- Available in single, double or triple point contact to address most applications
- Adjustable cam from 1-1/4" to 2"
- Includes gasket, cylinder and keys
- Designed to mount into a 3-3/4" x 4" recess opening (L8816 fits into 4-3/8" x 3-1/2" recess opening)

Part No.	Description	Face Dims. (HxW)	Wt. (lbs.)	Cat.
L8816	Single Point Latch Folding T-Handle with Blind Studs, Tall, Stainless Steel,	5.5" x 4.75"	1.50	510 (N)
L8815	Single Point Latch Folding T-Handle, with Mounting Holes, Stainless Steel	4.88" x 4.75"	1.25	510 (N)
L8855	Single Point Latch Folding-T Handle, with Blind Studs, Stainless Steel	4.88" x 4.75"	1.26	510 (N)
L8915	Single Point Latch Folding-T Handle, with Mounting Holes, Zinc Plated	4.88" x 4.75"	1.25	510 (N)
L8825	Double Point Latch Folding-T Handle, with Mounting Holes, Stainless Steel, Rods Included	4.88" x 4.75"	2.50	510 (N)
L8835	Triple Point Latch Folding-T Handle, with Mounting Holes, Stainless Steel, Rods Included	4.88" x 4.75"	2.75	510 (N)
L881XG0	Replacement Gasket for L8816	-	0.01	510 (N)
L8815G0	Replacement Gasket for L8815, L8855, L8915, L8825, L8835	-	0.01	510 (N)

Flush Mount T-Handle Latch for Buyers Poly Underbody Boxes



rear view

- Polished stainless steel
- 3-Point latch
- Adjustable cam from 0.25" to 1.6"
- Includes gasket, cylinder and keys
- Designed to mount into a 4-3/8" x 3-1/2" recess opening

***Replacement for Buyers poly underbody boxes only, will not work on standard underbody toolboxes**

Part No.	Description	Face Dims. (HxW)	Wt. (lbs.)	Cat.
L8816R	3-Point Latch Folding-T Handle, with Roller	5.5" x 4.75"	1.43	510 (N)

Standard Size Single-Point Rotary Paddle Latch



- Polished stainless steel
- Hidden studs
- Includes gasket, cylinder and keys
- Includes hasp for alternative lock. Requires 7/16" diameter pad lock shank (not included)

Part No.	Description	Face Dims. (HxW)	Wt. (lbs.)	Cat.
L3890RLS	Stainless Steel Rotary Single Point Paddle Latch, 1/4" Striker	5.5" x 4.75"	1.40	510 (N)
3005833	Striker Plate/Bracket; for use with L3890RLS	-	0.26	530-1 (N)

Standard Size Rectangular Rotary Paddle Latch



- Single point rotary latch
- Polished stainless steel
- Hidden studs
- Includes gasket, cylinder and keys
- Includes hasp for alternative lock. Requires 7/16" diameter pad lock shank (not included)

Part No.	Description	Face Dims. (HxW)	Wt. (lbs.)	Cat.
L3885RLS	Stainless Steel Rotary Single Point Paddle Latch, 1/2" Striker	5.5" x 4.25"	1.40	510 (N)
3002713	Striker Latch/Pin; for use with L3885RLS	-	0.16	530-1 (N)

Standard Size Rectangular Flush Mount Locking Paddle Latches



- Designed to mount in a 3-3/8" x 4-5/8" recess
- Single point latch
- Available in rust resistant steel or stainless steel

Part No.	Description	Face Dims. (HxW)	Wt. (lbs.)	Cat.
L3885	Stainless Steel Single Point Latch (locking) Thru-Hole Mount	5.5" x 4.25"	1.15	510 (N)
 04035	Stainless Steel Single Point Latch (locking) Thru-Hole Mount	5.5" x 4.25"	1.15	510 (N)
L3980	Rust Resistant Steel Single Point Latch (locking) Weld-On	4.75" x 4.25"	1.15	510 (N)

Standard Size Rectangular Flush Mount Non-Locking Paddle Latches



- Designed to mount in a 3-3/8" x 4-5/8" recess
- Single point latch
- Available in rust resistant steel or stainless steel

Part No.	Description	Face Dims. (HxW)	Wt. (lbs.)	Cat.
N3885	Stainless Steel Single Point Latch (non-locking) Thru-Hole Mount	5.5" x 4.25"	1.15	510 (N)
N3980	Rust Resistant Steel Single Point Latch (non-locking) Weld-On	5.5" x 4.25"	1.15	510 (N)

Junior Flush Mount Rectangular Locking Paddle Latches



- All junior size latches mount in a 2-3/4" x 3-3/4" recess
- Single point latch
- Available in rust resistant steel or stainless steel

Part No.	Description	Face Dims. (HxW)	Wt. (lbs.)	Cat.
L1883	Junior Size Stainless Steel Single Point Latch (locking) Thru-Hole Mount	4.75" x 3.63"	1.00	510 (N)
 04025	Junior Size Stainless Steel Single Point Latch (locking) Thru-Hole Mount	4.75" x 3.63"	1.00	510 (N)
L1980	Junior Size Rust Resistant Steel Single Point Latch (locking) Weld-On	4.75" x 3.63"	1.00	510 (N)

Junior Flush Mount Rectangular Non-Locking Paddle Latches



- All junior size latches mount in a 2-3/4" x 3-3/4" recess
- Single point latch
- Available in rust resistant steel or stainless steel

Part No.	Description	Face Dims. (HxW)	Wt. (lbs.)	Cat.
N1980	Junior Size Rust Resistant Steel Single Point Latch (non-locking) Weld-On	4.75" x 3.63"	1.00	510 (N)
N1883	Junior Size Stainless Steel Single Point Latch (non-locking) Thru-Hole Mount	4.75" x 3.63"	1.00	510 (N)



Cylinder and Keys

Mini Size Tear Drop Latch



- Ideal for use on toolboxes and other small compartment doors
- Polished stainless steel finish
- Locking version includes cylinder and two keys

Part No.	Description	Face Dims. (HxW)	Wt. (lbs.)	Cat.
8000SSL	Stainless Steel Mini Size Tear Drop Style Latch (Locking)	4.38" x 3.25"	0.57	510 (N)
8000SSN	Stainless Steel Mini Size Tear Drop Style Latch (non-Locking)	4.38" x 3.25"	0.55	510 (N)

Replacement Lock Cylinder & Key



- For standard and junior size latches
- Various keys upon request

Part No.	Description	Wt. (lbs.)	Cat.
19CH545	Cylinder and Key	0.09	510 (N)

Replacement Lock Cylinder & Key



- For standard and junior size latches
- Various keys upon request

Part No.	Description	Wt. (lbs.)	Cat.
39LL71	Cylinder and Key	0.09	510 (N)

Replacement Lock Cylinder & Key



- For standard and junior size latches
- Various keys upon request

Part No.	Description	Wt. (lbs.)	Cat.
L38RRLSCH545	Cylinder for L3885RLS Latch	0.25	510 (N)

Replacement Lock Cylinder & Key



- For standard and junior size latches
- Various keys upon request

Part No.	Description	Wt. (lbs.)	Cat.
88CH545	Cylinder for L8815/L8915/L8816 Latch	0.25	510 (N)
88CH510	Cylinder Lock For L8816 with 2 Keys	0.13	510 (N)

Zinc-Lock Cylinder Dust Cover



- Works with: 19CH545, 39LL71, 88CH545, 88CH510, & L38RRLSCH545

Part No.	Description	Wt. (lbs.)	Cat.
CDC01Z	Cylinder Dust Cover, Zinc Plated Die-Cast	0.04	510 (N)

Heavy Duty Hinged Security Hasp



SH35

- 17 gauge zinc plated steel
- Mounting screws included



SH40

- .125" thick clear zinc plated steel
- For use on heavy doors

Part No.	Description	Wt. (lbs.)	Cat.
SH35	Security Hasp, 3.47" L x 1.46" W, Zinc Plated	0.19	510 (N)
SH40	Security Hasp, 4.25" L x 2" W, Zinc Plated	0.82	510 (N)

Slam Bolt Latch



- Finger pull with manual release
- Powder coated metal bolt
- Zinc plated steel finish
- For use with two and three point latch applications

Part No.	Description	Handle Length	Wt. (lbs.)	Cat.
90M	Bolt Latch - Finger Pull Style; 5.5"L x 2"W	–	0.44	510 (N)

Spring Latch

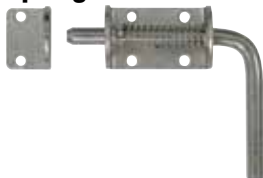

B2595LKB

- Spring loaded bolt can be locked in the open position
- Zinc plated bolt, housing and keeper
- Turning lever allows the bolt to close under spring pressure.

Part No.	Description	Handle Length	Wt. (lbs.)	Cat.
B2595LKB	1/2" Spring Latch Assembly with Keeper	3-7/8"	1.25	510 (N)
 06035	1/2" Spring Latch Assembly with Keeper	3-7/8"	1.25	510 (N)
B2595*	1/2" Spring Latch Assembly, 5.19"L x 1.75"W	3-7/8"	0.85	510 (N)
B2595SH*	1/2" Spring Latch Assembly with Short Handle; 5.19"L x 1.75"W	2-3/8"	0.85	510 (N)
B2575*	1/2" Spring Latch Assembly, Zinc; 6.5"L x 1.56"W	1-3/8"	0.82	510 (N)
3009988*	1/2" Spring Latch Assembly, Stainless Steel; 8.38"L x 2.75"W	1-1/2"	1.0	510(N)
B2595KZ	1/2" Keeper Only; 1.75" L x 1.75" W	–	0.4	510 (N)
NEW 3034902	1/2" Pin, Spring Loaded, Unpainted; 6.5" L x 1.56" W	1-3/8"	0.82	510 (N)

* Keeper Sold Separately

See www.buyersproducts.com for complete dimensions

Heavy Duty Spring Latch



B2596

- Spring loaded bolt can be locked in the open position
- Zinc plated bolt, housing and keeper
- Turning lever allows the bolt to close under spring pressure.

Part No.	Description	Handle Length	Wt. (lbs.)	Cat.
B2596LKB	3/4" Spring Latch Assy., with Keeper	3-1/2"	2.8	510 (N)
B2596LKBSS	3/4" Spring Latch Assy., with Keeper, Stainless Steel	3-1/2"	2.7	510 (N)
B2596*	3/4" Heavy Duty Spring Latch Assy.*; 5.91"L x 2.09"W	3-1/2"	1.25	510 (N)
B2596SS*	3/4" Heavy Duty Spring Latch Assy., Stainless Steel	3/4"	2.05	510 (N)
B2596KZ	3/4" Heavy Duty Keeper Only	–	0.6	510 (N)
B2596KSS	3/4" Heavy Duty Keeper Only, Stainless Steel	–	0.5	510 (N)

* Keeper Sold Separately

See www.buyersproducts.com for complete dimensions

Weld-On Spring Latch



- Spring loaded bolt can be locked in the open position
- 5/8" heat treated pin (B2598SSC has stainless steel pin)
- Stainless steel spring and spring pin
- Available unassembled

Part No.	Description	Handle Length	Wt. (lbs.)	Cat.
B2598H	5/8" Spring Latch with Plain Tube; 4.68"L x 2.53"W	–	0.7	510 (N)
B2598HU	5/8" Spring Latch with Plain Tube; 4.68"L x 2.53"W, Unassembled	–	0.7	510 (N)
B2598SSC	5/8" Spring Latch with Stainless Steel Tube and Pin	–	0.74	510 (N)
B2598LP	5/8" Spring Latch with Plain Tube and 1.31"L Extended Plunger	–	1.0	510 (N)



Latches

Quick Release Spring Latch



- Spring loaded bolt can be locked in open position

Part No.	Description	Wt. (lbs.)	Cat.
B2599RH	Spring Latch, Right Hand; 4.75"L x 1.125"W	0.75	510 (N)
B2599LH	Spring Latch, Left hand; 5"L x 2"W	0.75	510 (N)

Snap Lock Latch



- 1/2" square spring loaded bolt
- Zinc plated

Part No.	Description	Wt. (lbs.)	Cat.
B2586	1/2" Snap Lock	1.75	510 (N)

Stake Body Spring Latch



- Spring loaded handle
- Zinc plated bolt and housing
- Stainless steel spring

Part No.	Description	Handle Length	Wt. (lbs.)	Cat.
B2590LH	1/2" Spring Latch Assy. Left Hand*; 6.09"L x 1.69"W	2-3/4"	0.85	510 (N)
B2590RH	1/2" Spring Latch Assy. Right Hand*; 6.09"L x 1.69"W	2-3/4"	0.85	510 (N)
B2590KZ	90° Keeper for B25290LH & B25290RH; 3.81"L x 2.5"W	—	0.85	510 (N)

Tipper Latch





- Zinc plated steel
- Ships assembled

Part No.	Description	Wt. (lbs.)	Cat.
TL382	Tipper Latch Assembly	1.25	510 (N)

Easy Grip Rubber Hood Catch



WJ195

Part No.	Description	Wt. (lbs.)	Cat.
WJ195*	4" "Easy Grip" Rubber Hood Catch with Bracket	0.30	522 (N)
WJ201A	4-7/8" Rubber Hood Catch with "A" Bracket	0.32	522 (N)
 03010	WJ201A Retail Packaged	0.32	522 (N)
WJ201U	4-7/8" Rubber Hood Catch with "U" Bracket	0.32	522 (N)
 03015	WJ201U Retail Packaged	0.32	522 (N)
WJ202	2-1/2" Miniature Rubber Hood Catch with Bracket	0.13	522 (N)
WJ201SS	Rubber Hood Catch with Stainless Steel Hardware	0.32	522 (N)

*WJ195 compares to Southco® Part No. 37-10-086-10

6" Heavy Duty Rubber Hood Catch



WJ205

Part No.	Description	Wt. (lbs.)	Cat.
WJ205	6" Heavy Duty Rubber Hood Catch, Includes Brackets and Pin, No Bumper	0.43	522 (N)
WJ205RO	6" Heavy Duty Rubber Hood Catch, Handle Only, No Bumper	0.43	522 (N)

6" Heavy Duty Rubber Hood Catch with Bumper



WJ206

7-7/8" Heavy Duty Rubber Hood Catch



Part No.	Description	Wt. (lbs.)	Cat.
 WJ206	6" Heavy Duty Rubber Hood Catch, Includes Brackets and Pin	0.44	522 (N)
03020	WJ206 Retail Packaged	0.44	522 (N)
WJ206RO	6" Heavy Duty Rubber Hood Catch, Handle Only	0.44	522 (N)

Part No.	Description	Wt. (lbs.)	Cat.
 WJ208	7-7/8" Heavy Duty Rubber Hood Catch, Includes Brackets and Pin	0.45	522 (N)
03025	WJ208 Retail Packaged	0.45	522 (N)
WJ208RO	7-7/8" Heavy Duty Rubber Hood Catch, Handle Only	0.45	522 (N)

*Buyers Products is not authorized by nor affiliated with the manufacturer of Southco® products.



Products are Retail Packaged



Rubber Hood Latches

12" Rubber/Polymer Hood Catch



Part No.	Description	Wt. (lbs.)	Cat.
WJ211	12" Rubber/Polymer Hood Catch	0.50	522 (N)
03030	12" Rubber/Polymer Hood Catch	0.50	522 (N)

WJ211 compares to Standard Navistar™* hood catch.

9" Rubber/Polymer Draw Latch



Part No.	Description	Wt. (lbs.)	Cat.
WJ212	9" Rubber/Polymer Draw Latch	0.50	510 (N)

WJ212 compares to Southco®* Part No. 37-30-294-60

4-1/4" Rubber/Polymer Draw Latch



Part No.	Description	Wt. (lbs.)	Cat.
WJ215	4-1/4" Rubber/Polymer Draw Latch	0.25	510 (N)

13-1/4" Rubber/Polymer Draw Latch



Part No.	Description	Wt. (lbs.)	Cat.
WJ213	13-1/4" Rubber/Polymer Draw Latch	0.50	510 (N)

WJ213 compares to Southco®* Part No. 37-140-295-60

*Buyers Products is not authorized by nor affiliated with the manufacturer of Southco® or Standard Navistar™ products.

Padlock Eye Pull-Down Catch



- Catch complete with striker
- Zinc plated steel

Part No.	Description	Wt. (lbs.)	Cat.
BHC207Z	Padlock Eye Pull-Down Catch with Striker	0.15	510 (N)

Large Padlock Eye Pull-Down Catch



- Catch complete with striker
- Zinc plated steel

Part No.	Description	Wt. (lbs.)	Cat.
BHC227Z	Large Padlock Eye Pull-Down Catch with Striker	0.15	510 (N)

Hook Style Heavy Duty Pull-Down Catch



- Used for general purpose
- Toggle-action
- Zinc plated steel
- Does not come with striker

Part No.	Description	Wt. (lbs.)	Cat.
BHC801Z	Heavy Duty Pull-Down Catch	0.15	510 (N)

Spring Loaded 90° Hood Catch



- 90° elbow at base of handle allows handle and bracket to be mounted on same plane
- Black enamel finish
- Includes hooking bracket

Part No.	Description	Wt. (lbs.)	Cat.
WJ96WCB	Spring Loaded 90° Hood Catch with Keeper and Hardware	0.31	522 (N)

Heavy Duty Adjustable Draw Latch



- Zinc plated steel

WJ225

Part No.	Description	Wt. (lbs.)	Cat.
WJ225	Heavy Duty Adjustable Draw Latch	0.78	522 (N)

Utility Hook



- 1-1/2" x 2"
- Zinc
- 3/4" W x 1 1/2" L mounting plate
- 15/16" hook opening
- 2" overall length
- Commonly used as catch for WJ2225

3013332

Part No.	Description	Wt. (lbs.)	Cat.
3013332	Utility Hook, 1-1/2" x 2", Zinc	0.12	520(N)



Butt Hinge & Continuous Hinge

Steel Butt Hinge



- No holes
- Plain finish
- Tight pin (spun both ends)

Part No.	Thickness	Open Width	Pin DIA.	Length	Cat.
BTS062012	.060"	2"	.125"	2"	484 (N)
BTS072018	.075"	2"	.187"	2"	484 (N)
BTS093018	.090"	3"	.187"	3"	484 (N)
BTS123025	.120"	3"	.250"	3"	484 (N)
BTS124025	.120"	4"	.250"	4"	484 (N)

Stainless Steel Butt Hinge



- No holes
- Plain finish
- Tight pin (spun both ends)

Part No.	Thickness	Open Width	Pin DIA.	Length	Cat.
BTSS123025	.120"	3"	.250"	3"	484 (N)
BTSS124025	.120"	4"	.250"	4"	484 (N)

Steel Continuous Hinge



- Equal Leaves
- Steel Pins
- Stock Length 72"
- 96" lengths are available by special order
- Stainless steel or brass pins are available by special order

Part No.	Thickness	Gauge	Open Width	Pin DIA.	Knuckle Length	Cat.
S41	.075"	14	1-1/2"	3/16"	1"	480 (N)
S42	.075"	14	2"	3/16"	1"	480 (N)
S43	.075"	14	2-1/2"	3/16"	1"	480 (N)
S47	.075"	14	1-1/2"	1/4"	1"	480 (N)
S48	.075"	14	2"	1/4"	1"	480 (N)
S49	.075"	14	2-1/2"	1/4"	1"	480 (N)
S50	.075"	14	3"	1/4"	1"	480 (N)
S5313	.093"	13	2"	1/4"	1"	480 (N)
S55	.075"	14	3"	1/4"	2"	480 (N)
S63	.120"	11	2"	3/8"	2"	480 (N)
S64	.120"	11	2-1/2"	3/8"	2"	480 (N)
S65	.120"	11	3"	3/8"	2"	480 (N)
S67	.120"	11	4"	3/8"	2"	480 (N)
S72	.187"	7	3"	1/2"	2"	480 (N)
S73	.187"	7	4"	1/2"	2"	480 (N)
S75	.187"	7	6"	1/2"	2"	480 (N)

Stainless Steel Continuous Hinge



- Type 302 Stainless Steel
- Equal Leaves
- Stainless Steel Pins
- Stock Length 72"
- 96" lengths are available by special order

Part No.	Thickness	Gauge	Open Width	Pin DIA.	Knuckle Length	Cat.
SS8	.062"	16	1-1/2"	.125"	1/2"	500 (N)
SS9	.062"	16	2"	.125"	1/2"	500 (N)
SS11	.062"	16	3"	.125"	1/2"	500 (N)
SS12	.062"	16	2"	.187"	1/2"	500 (N)
SS15	.075"	14	2"	.250"	1"	500 (N)
SS15N	.075"	14	2"	.187"	1"	500 (N)
SS16	.075"	14	2-1/2"	.250"	1"	500 (N)
SS17	.075"	14	3"	.250"	1"	500 (N)
SS18	.075"	14	4"	.250"	1"	500 (N)
SS19	.120"	11	2"	.375"	2"	500 (N)
SS20	.120"	11	3"	.375"	2"	500 (N)
SS21	.120"	11	4"	.375"	2"	500 (N)

Aluminum Continuous Hinge



- Equal Leaves
- Full Hard Aluminum Pins
- Stock Length 72"
- 96" lengths are available by special order

Part No.	Thickness	Gauge	Open Width	Pin DIA.	Knuckle Length	Cat.
A23	.062"		2"	3/16"	1/2"	490 (N)
A29	.075"		2"	3/16"	1/2"	490 (N)
A34	.093"		2"	1/4"	1"	490 (N)
A36	.093"		3"	1/4"	1"	490 (N)
A41	.120"		3"	3/8"	2"	490 (N)
A42	.120"		4"	3/8"	2"	490 (N)

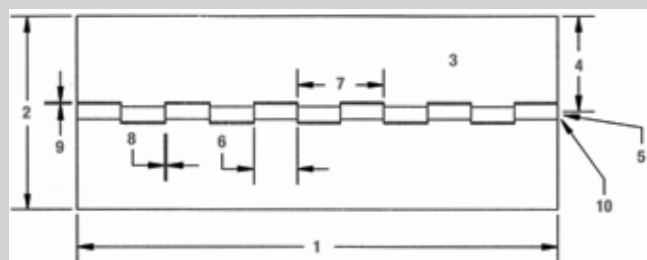

Continuous Hinge

- Hinge Length:** The length of the leaves measured parallel to the pin.
- Hinge Width:** The over-all dimension of the leaves measured perpendicular or across the pin.
- Leaf:** That portion of a hinge extending laterally from the knuckle, which generally revolves around a pin.
- Leaf Width:** The dimension from the center of the pin to the outer edge of the leaf.
- Knuckle:** The hollow circular part at the joint of a hinge through which a pin is passed. Sometimes called loop, joint, node or curl.
- Knuckle Length:** The nominal or typical dimension of the knuckle measured parallel to the pin.
- Pitch:** The dimension from a point on the knuckle to the same point on an adjacent knuckle on the same leaf.
- End Play:** The amount of axial movement between the leaves.
- Paint Clearance:** The dimension between the outer face of the knuckle and the opposing edge of the leaf cutout over the entire range of pivotal movement of the hinge.
- Pin:** Diameter of rod.



Weld-On Hinges

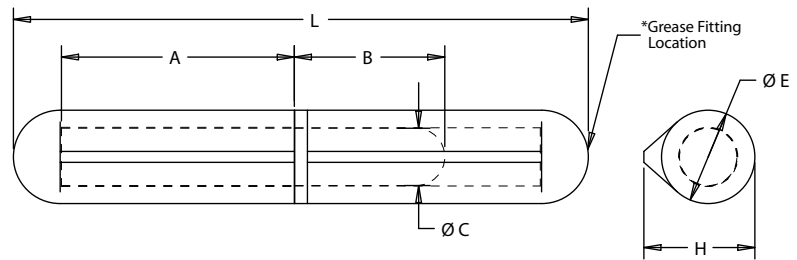

Steel Weld on "Bullet" Hinge



- Steel with steel pin and brass bushing

Part No.	Length (L)	Thickness (H)	Diameter (E)	Pin Length		Pin Diameter	Wt. (lbs.)	Cat.
				(A)	(B)			
FSP050	1.97"	0.39"	0.32"	0.79"	0.55"	0.20"	0.04	494 (N)
FSP070	2.76"	0.51"	0.45"	1.14"	0.67"	0.24"	0.13	494 (N)
FSP080	3.15"	0.61"	0.51"	1.28"	0.83"	0.32"	0.19	494 (N)
FSP100	3.94"	0.77"	0.63"	1.65"	1.16"	0.39"	0.35	494 (N)
FSP120	4.72"	0.77"	0.63"	2.01"	1.26"	0.39"	0.44	494 (N)
FSP150	5.91"	0.98"	0.79"	2.48"	1.57"	0.51"	0.85	494 (N)
FSP200	7.87"	1.12"	0.91"	3.46"	2.05"	0.63"	1.50	494 (N)
FSP260	10.24"	1.46"	1.10"	4.53"	2.87"	0.75"	2.93	494 (N)

Steel Weld on "Bullet" Hinge with Brass Pin



- Steel with brass pin and brass bushing

Part No.	Length (L)	Thickness (H)	Diameter (E)	Pin Length		Pin Diameter	Wt. (lbs.)	Cat.
				(A)	(B)			
FBP080	3.15"	0.61"	0.51"	1.28"	0.83"	0.32"	0.19	494 (N)
FBP100	3.94"	0.77"	0.63"	1.65"	1.16"	0.39"	0.37	494 (N)
FBP150	5.91"	0.98"	0.79"	2.48"	1.57"	0.51"	0.88	494 (N)

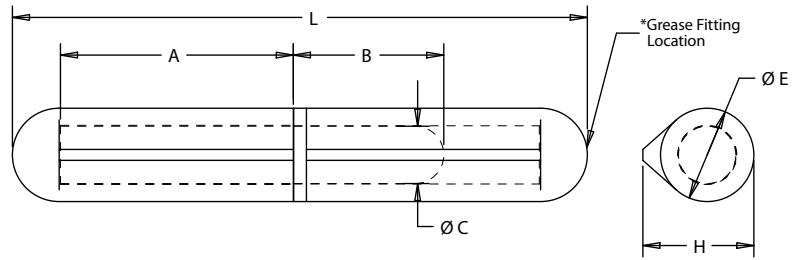

Weld on "Bullet" Hinge



- Stainless steel with stainless steel pin and bushing

Part No.	Length (L)	Thickness (H)	Diameter (E)	Pin Length		Pin Diameter	Wt. (lbs.)	Cat.
				(A)	(B)			
FSS070	2.76"	0.51"	0.45"	1.14"	0.67"	0.24"	0.13	494 (N)
FSS100	3.94"	0.77"	0.63"	1.65"	1.16"	0.39"	0.35	494 (N)

Weld on "Bullet" Hinge



- Aluminum with stainless steel pin and bushing

Part No.	Length (L)	Thickness (H)	Diameter (E)	Pin Length		Pin Diameter	Wt. (lbs.)	Cat.
				(A)	(B)			
AFSSP080	3.15"	0.61"	0.51"	1.28"	0.83"	0.32"	0.09	494 (N)
AFSSP100	3.94"	0.77"	0.63"	1.65"	1.16"	0.39"	0.18	494 (N)

Steel Weld on "Bullet" Hinge with Grease Fitting



- Steel with brass pin, brass bushing, and grease fitting

Part No.	Length (L)	Thickness (H)	Diameter (E)	Pin Length		Pin Diameter	Wt. (lbs.)	Cat.
				(A)	(B)			
FBP080GF*	3.15"	0.61"	0.51"	1.28"	0.83"	0.32"	0.19	494 (N)
FBP100GF*	3.94"	0.77"	0.63"	1.65"	1.16"	0.39"	0.35	494 (N)
FBP120GF*	4.72"	0.77"	0.63"	2.01"	1.26"	0.39"	0.43	494 (N)
FBP150GF*	5.91"	0.98"	0.79"	2.48"	1.57"	0.51"	0.87	494 (N)



Hinges

Zinc Plated Butt Hinge



- Flush mounted wing style
- Zinc plated steel construction
- Stainless steel pin
- Single end weld for left or right mount

Part No.	Description	Pin Size	Wt. (lbs.)	Cat.
H412538RH	Butt Hinge, 4" L x 1-1/4" W, Right	3/8"	0.60	484 (N)
H412538LH	Butt Hinge, 4" L x 1-1/4" W, Left	3/8"	0.60	484 (N)
H412550RH	Butt Hinge, 4" L x 1-1/4" W, Right	1/2"	0.75	484 (N)
H412550LH	Butt Hinge, 4" L x 1-1/4" W, Left	1/2"	0.75	484 (N)

Steel Butt Hinge



- Flush mounted wing style
- Steel construction
- Pin not welded
- Plain finish

Part No.	Description	Pin Size	Wt. (lbs.)	Cat.
H2550	Butt Hinge, 5-1/2" L x 2-1/2" W	1/2"	0.90	484 (N)

Strap Hinge



- Strap: 3/16" steel, 2-1/4" wide
- Bracket: 3/16" steel 3" wide, 5" high
- Pin: 1/2" dia. steel, steel thrust bearings
- *Strap length is measured from center of pin to end of strap.*

Part No.	Description	Pin Size	Wt. (lbs.)	Cat.
B2423F	8" Strap, 10.56" L x 5" W	1/2"	2.45	486 (N)
B2423G	12" Strap, 15.19" L x 5" W	1/2"	3.80	486 (N)
B2423H	16" Strap, 18.81" L x 5" W	1/2"	4.50	486 (N)

Stainless Steel Strap Hinge



- Strap: 1/8" stainless steel, 1" wide
- Bracket: 1/8" steel 2-3/4" wide, 1" high
- Pin: 5/16" diameter, nylon bushing

Part No.	Description	Pin Size	Wt. (lbs.)	Cat.
B2424SS	3-5/8" Strap, 4" W x 2-3/4" W	5/16"	0.25	486 (N)

Cargo Trailer Flush Hinge



- Flush steel hinge
- 1/4" pin
- Countersunk holes and nylon bushings

Part No.	Description	Pin Size	Wt. (lbs.)	Cat.
B2426SSCL	Cast Zinc, Polished Finish, 5.59" L x 3.28" W, Left	1/4"	0.71	486 (N)
B2426SSCR	Cast Zinc, Polished Finish, 5.59" L x 3.28" W, Right	1/4"	0.71	486 (N)

Formed Steel Strap Hinge



- Formed .31" thick steel hinge
- Includes zinc washer, hex head cap screw and locknut, plastic bushing
- 3008649 optional steel bushing

Part No.	Description	Wt. (lbs.)	Cat.
B2426FS	Formed Hinge Strap with Grease Fitting; 3.85" L x 4.33" W x 2.44" T	2.25	486 (N)
3008647	Steel Bushing for B2426F Series Hinge, Replaces Standard Poly Bushing	0.01	486 (N)

Formed Steel Long Leaf Strap Hinge



- Formed .31" thick steel hinge
- Includes zinc washer, hex head cap screw and locknut, plastic bushing
- 3008649 optional steel bushing

Part No.	Description	Wt. (lbs.)	Cat.
B2426FSSL	Formed Hinge Strap with Grease Fitting, Long Leaf; 5.85" L x 4.33" W x 2.44" T	2.62	486 (N)
3008647	Steel Bushing for B2426F Series Hinge, Replaces Standard Poly Bushing	0.01	486 (N)

Formed Steel Straight Strap Hinge



- Formed .31" thick steel hinge
- Includes zinc washer, hex head cap screw and locknut, plastic bushing
- 3008649 optional steel bushing

Part No.	Description	Wt. (lbs.)	Cat.
B2426FSNB	Formed Hinge Strap with Grease Fitting, Straight Strap; 3.85" L x 4.35" W x 2.44" T	2.22	486 (N)
3008647	Steel Bushing for B2426F Series Hinge, Replaces Standard Poly Bushing	0.01	486 (N)

Forged Hinge Strap



B2429X



B2430W

- Drop forged steel hinge straps offer strength with reduced weight
- May be welded, bolted or riveted
- Works with B2426E

Part No.	Description	C Eye to End	Strap Width	Hole	Wt. (lbs.)	Cat.
B2429X	Forged Hinge Strap, Short	4-3/8"	1-1/2"	1/2"	1.24	486 (N)
B2430W	Forged Hinge Strap, Long	24"	1-1/2"	33/64"	4.60	486 (N)

Forged Butt Hinge



- Consists of drop forged butt, hinge pin and cotter key
- Width of opening: 1-1/2"
- Holes in flat, Center to Center: 4"
- Projection: 2"
- Dia. of eye: 11/8"
- Holes in eye: 7/32"
- Pin size: 1/2"

Part No.	Description	Wt. (lbs.)	Cat.
B2426E	Forged Hinge Butt with Pin & Cotter; 5-3/8" W x 3-3/8" W	1.35	486 (N)



Overhead Door Checks / Door Props

Door Check & Hold Back



- Spring permits slide to pass over center and hold door at 90°
- Releases automatically and door closes by slight push
- Works on doors with vertical or horizontal hinges
- Parts are cadmium plated for long life

Part No.	Description	Wt. (lbs.)	Cat.
BH2395AA11	Door Check and Hold Back; 11" Arm, 13" Slide Rod, and 50# Spring	1.87	514 (N)
BM2395AA11	Door Check and Hold Back; 11" Arm, 13" Slide Rod, and 30# Spring	1.69	514 (N)

Telescoping Door & Lid Prop



- Prevents accidental closing
- Automatically locks when extended
- Unlocks automatically when extended slightly in the up position
- All steel construction
- Sturdy mounting clamps
- Zinc plated to resist rust and corrosion

Part No.	Description	Wt. (lbs.)	Cat.
DP100	21" Extended/13.125" Retracted Telescoping Door and Lid Prop	0.87	514 (N)
DP102	12-1/4" Extended/8.5" Retracted Telescoping Door and Lid Prop	0.87	514 (N)

HD Aluminum Hook and Keeper Door Hold Back

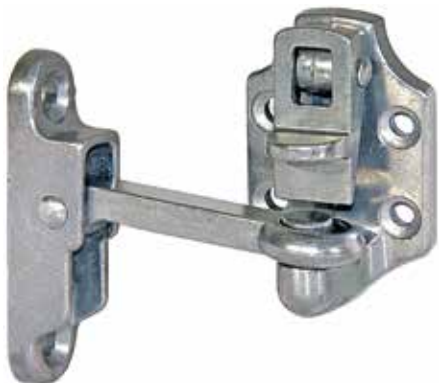

- Heavy duty die cast aluminum construction
- Available in 2" or 4" lengths
- Keeper has spring loaded latch mechanism

Part No.	Description	Wt. (lbs.)	Cat.
DH300	Aluminum Door Hold Back, 2" Hook & Keeper	0.30	514 (N)
DH304	Aluminum Door Hold Back, 4" Hook & Keeper	0.29	514 (N)

Zinc Plated Hook & Keeper Door Holder

- Zinc plated or stainless steel stamping



Part No.	Description	Wt. (lbs.)	Cat.
DH500	4" Hook & Keeper, Zinc Plated	0.50	514 (N)
DH500SS	4" Hook & Keeper, Stainless Steel	0.36	514 (N)
DH501	4" Hook Only, Zinc Plated	0.25	514 (N)
DH5006	6" Hook & Keeper, Zinc Plated	0.70	514 (N)
DH5006SS	6" Hook & Keeper, Stainless Steel	0.38	514 (N)
DH502	Keeper Only, Zinc Plated	0.25	514 (N)

Gas Spring



- Dampened extension
- Undampened compression
- Black powder coated cylinder

Part No.	Extended Length	Compressed Length	Stroke	Rod Diameter	Cylinder Diameter	Ball Socket Diameter	Force Rating (lbs.)	Wt. (lbs.)	Cat.
3010339	17"	10"	7"	6mm	15mm	10mm	20	0.42	530-1 (N)
3025622	12"	8"	4"	6mm	15mm	10mm	30	0.43	530-1 (N)
3028786	13.93"	8.5"	5.5"	8mm	18mm	10mm	35	0.51	520 (N)
3025623	12"	8"	4"	6mm	15mm	10mm	40	0.27	530-1 (N)
3026586	12"	8"	4"	6mm	15mm	10mm	50	0.42	530-1 (N)
NEW 3029916	12"	8"	4"	6mm	15mm	10mm	60	0.27	530-1 (N)
3028392	12"	8"	4"	6mm	15mm	10mm	80	0.42	530-1 (N)
3029917	12"	8"	4"	9.65mm	18.13mm	10mm	100	0.38	530-1 (N)
3022729	12"	8"	4"	6mm	15mm	10mm	25	0.27	530-1 (N)
3023460	19.63"	11.63"	8"	9.98mm	21.59mm	10mm	250	0.85	903-2 (N)
3008745	10mm Ball Stud (Sold Separately except for 3028786)							0.03	530-1 (N)
FNE031018034	Nylock Nut for Ball Stud (Sold Separately except for 3023460)							0.01	530-1 (N)



Products are Retail Packaged



Door Locks and Handles

Trailer Door Cam Action Door Lock Kit

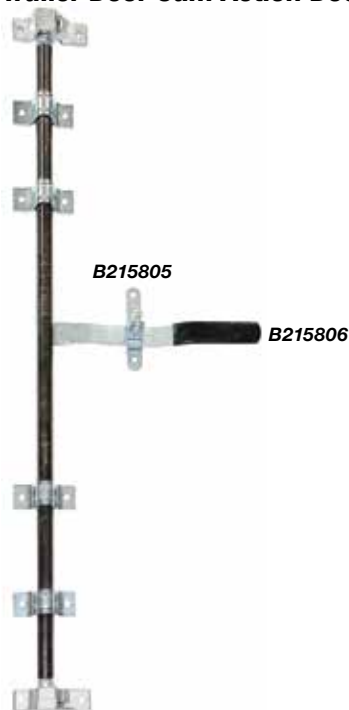

- Cast steel cups, lugs, steel handle (13") & supports
- For use with 3/4" pipe (not available)
- Sold as kit only

Part No.	Description	Wt. (lbs.)	Cat.
B2159C	Cam Action Door	7.0	513 (N)
B215805	Cam Locking Hasp Replacement for B2159C	0.44	520 (N)
B215806	Handle Replacement for B2159C	1.43	520 (N)

"T" Type Locking Door Handle



- Chrome plated handles rotate full 360°
- Shaft is standard 5/16" sq. x 4-3/16"L
- 1-1/2" C-C mounting holes
- Can be locked in 4 positions spaced 90° apart

Part No.	Description	Wt. (lbs.)	Cat.
B2392L	"T" Type Locking Door Handle, 3-7/8" Handle Length, CL001 key	0.53	513 (N)
04010	"T" Type Locking Door Handle, 3-7/8" Handle Length, CL001 key	0.53	513 (N)

"L" Type Locking Door Handle



- Chrome plated handles rotate full 360°
- Shaft is standard 5/16" sq. x 2-11/16"L
- 1-1/2" C-C mounting holes
- Can be locked in 4 positions spaced 90° apart

Part No.	Description	Wt. (lbs.)	Cat.
B2394L	"L" Type Locking Door Handle, 3-1/2" Handle Length, CL001 key	0.48	513 (N)
04005	"L" Type Locking Door Handle, 3-1/2" Handle Length, CL001 key	0.48	513 (N)

Single Point Cam



- Complete with set screw
- Zinc die cast
- Secures to 5/16" Shaft
- For use with B2392L & B2394L

Part No.	Description	Wt. (lbs.)	Cat.
B239CZ	Single Point Cam with Set Screw	0.10	513 (N)

Zinc Plated Security Lock & Hasp



- Cylindrical lock provides maximum protection
- Hasp shields the cylinder, providing extra security
- Heavy duty chrome-plated steel lock with two keys
- Zinc-plated hasp
- Includes all mounting fasteners
- Lock & hasp sold separately
- Packaged for retail display

Part No.	Description	Wt. (lbs.)	Cat.
 SL100	Chrome Plated Security Lock, Shielded	3.0	513 (N)
 SLH100	Zinc Plated Hasp for Security Lock; 9"L x 4.5"W	2.7	513 (N)

Forge Lever Nut



- Lever is offset 1-1/2"

Part No.	Length C to End	Round	Size Thread	Wt. (lbs.)	Cat.
B575A	3-3/4"	3/8"	3/8 - 16 N.C.	0.24	513 (N)
B575CZ*	4"	7/16"	1/2 - 13 N.C.	0.24	513 (N)
B575GZ*	6"	5/8"	3/4 - 10 N.C.	0.59	513 (N)

*Zinc Plated

Cast Iron Wing Style Clamp Handle



- 5/8-11 Full thread cast iron
- Ideal for securing doors, chutes and tailgates using a 5/8-11 rod
- Zinc plated

Part No.	Description	Wt. (lbs.)	Cat.
WN5811Z	Wing Nut Handle, Zinc Plated; 5.5"L x 2.38"T	0.60	513 (N)

Forged Rod End

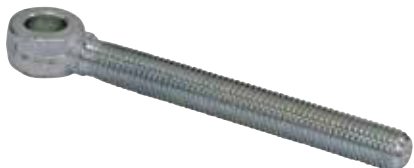

- 5/8-11 x 6" forged rod end (4-1/2" of thread)
- Zinc plated
- 5/8" PH

Part No.	Description	Wt. (lbs.)	Cat.
B27027EKZ	Forged Rod End, Zinc Plated	0.50	513 (N)



Pins

Zinc Plated Linch Pins

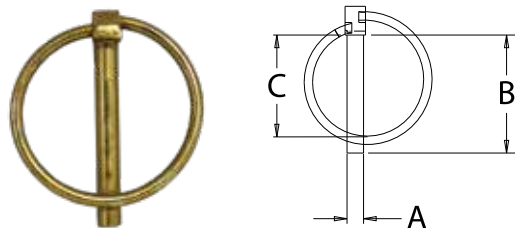

- Yellow zinc plated
- Packaged parts are two pieces per clam shell

Part No.	A	B	C	Cat.
66000	.25"	1.75"	1.50"	518 (N)
66003	.19"	1.38"	1.10"	518 (N)
66004	.19"	1.38"	1.10"	518 (N)
66006	.31"	1.75"	1.44"	518 (N)
66010	.44"	1.75"	1.50"	518 (N)
66015	.44"	1.97"	1.50"	518 (N)

* Must buy in case quantity

Poly-Coated Steel Hitch Pins



- Silver powder coated steel pin shank
- High visibility blue poly-coated handle makes pin easy to see
- Includes zinc plated cotter pin
- SAE AISI 1541
- 20 Rc

Part No.	Description	Cat.
66101	Hitch Pin 1/2" x 4" usable length	518 (N)
66107	Hitch Pin 5/8" x 4" usable length	518 (N)
66111	Hitch Pin 3/4" x 4-1/2" usable length	518 (N)
66122	Hitch Pin 7/8" x 4-1/2" usable length	518 (N)
66127	Hitch Pin 1" x 4-1/2" usable length	518 (N)

Hitch Pins



- Forged 1040 steel
- Yellow zinc plated
- Spring wire handle
- Includes cotter pin

Part No.	Description	Cat.
66100	Hitch Pin 1/2" X 4-1/4" usable length	518 (N)
66102	Hitch Pin 9/16" X 2-3/4" usable length	518 (N)
66103	Hitch Pin 5/8" X 4-1/4" usable length	518 (N)
66105	Hitch Pin 5/8" X 6-1/4" usable length	518 (N)
66110	Hitch Pin 3/4" X 4-1/4" usable length	518 (N)
66115	Hitch Pin 3/4" X 6-1/4" usable length	518 (N)
66120	Hitch Pin 7/8" X 6-1/4" usable length	518 (N)
66125	Hitch Pin 1" X 6-1/4" usable length	518 (N)
66130	Hitch Pin 1-1/8" x 6-1/4" usable length	518 (N)
66135	Hitch Pin 1-1/4" X 7" usable length	518 (N)

Zinc Plated Snapper Pins

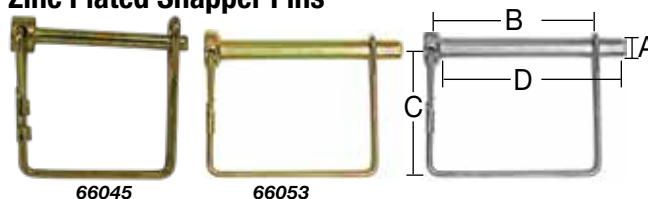

- Yellow zinc plated
- Packaged parts are two pieces per clam shell
- 3034842-12" Chain with S-hook included

Part No.	A. Pin Dia.	B. Usable Length	C. Clearance	D. Pin Length	Cat.
66045	3/16"	1-5/8"	1-5/8"	1-13/16"	518 (N)
66050	1/4"	1-13/16"	1-1/2"	2"	518 (N)
66051	1/4"	1-13/16"	1-1/2"	2"	518 (N)
66053	5/16"	2-19/32"	1-5/8"	2-25/32"	518 (N)
66054	5/16"	2-19/32"	1-5/8"	2-25/32"	518 (N)
66056	3/8"	1-17/32"	1-17/32"	1-5/8"	518 (N)
66060	3/8"	2-11/32"	1-1/2"	2-1/2"	518 (N)
66061	3/8"	2-11/32"	1-1/2"	2-1/2"	518 (N)
66063	1/4"	2-1/2"	1-3/4"	2-49/64"	518 (N)
66064	1/4"	2-1/2"	1-3/4"	2-49/64"	518 (N)
66066	1/4"	3"	1-1/2"	3-1/4"	518 (N)
66067	1/4"	3"	1-1/2"	3-1/4"	518 (N)
66070	1/4"	3-5/8"	1-1/2"	3-3/4"	518 (N)
NEW 66073	1/2"	2-1/2"	2-1/2"	1-1/2"	518 (N)
NEW 3034842	1/4"	3-1/2"	3-1/2"	1-1/2"	518 (N)

* Must buy in case quantity

Hitch Pin Assemblies



Part No.	Description	Wt (lbs.)	Cat.
66128	Pin Assy., 1" x 5", Usable Length 4-1/2"	1.43	518 (N)
66129	Pin Assy., 1" x 10-1/4", Usable Length 9-1/2"	2.58	518 (N)
66150	Pin Assy., 1-1/4" x 4", Usable Length 2-3/4"	1.74	518 (N)
66155	Pin Assy., 1-1/4" x 5", Usable Length 4-1/8"	2.15	518 (N)
66160	Pin Assy., 1-1/4" x 8-3/8", Usable Length 7-1/4"	3.27	518 (N)
66170	Pin Assy., 1-1/4" x 11", Usable Length 9-7/8"	4.14	518 (N)

Twist Lock Plunger Pin



- Spring-loaded pins (available in 0.625", 0.750", or 1.00")
- Includes grease fitting
- Zinc plated
- Commonly used with farm implements and wrecker attachments

Part No.	Description	Cat.
TLP625	5/8" dia.; 3-1/8" T x 1-1/8" W	518 (N)
TLP750	3/4" dia.; 3-1/8" T x 1-1/4" W	518 (N)
TLP100	1" dia.; 3-1/2" T x 1-3/8" W	518 (N)

Clevis Rod End with Pin and Cotter Pin



- Zinc Plated
- Includes clevis, pin, and cotter pin

Part No.	Description	Wt. (lbs.)	Cat.
B27081AZKT	B27081AZ 3/16" Clevis, Pin & Cotter Pin	0.04	730 (N)
B27082AZKT	B27082AZ 1/4" Clevis, Pin & Cotter Pin	0.09	730 (N)
B27083AZKT	B27083AZ 5/16" Clevis, Pin & Cotter Pin	0.13	730 (N)
B27083A14ZKT	B27083A14Z 5/16" Clevis, Pin & Cotter Pin	0.14	730 (N)
B27084AZKT	B27084AZ 3/8" Clevis, Pin & Cotter Pin	0.22	730 (N)
B27084A14ZKT	B27084A14Z 3/8" Clevis, Pin & Cotter Pin	0.23	730 (N)
B27084A56ZKT	B27084A456ZY 3/8" Clevis, Pin & Cotter Pin	0.22	730 (N)
B27086A56ZKT	B27086A56ZY 1/2" Clevis, Pin & Cotter Pin	0.44	730 (N)
B27086A38ZKT	B27086A38Z 1/2" Clevis, Pin & Cotter Pin	0.44	730 (N)
B27086ANFZKT	B27086ANFZ 1/2" Clevis, Pin & Cotter Pin	0.44	730 (N)
B27087CKT	B27087C 5/8" Clevis, Pin & Cotter Pin and Includes Nut	0.37	730 (N)

Clevis Pin



- S.A.E. standard
- Can be ordered with a cadmium or zinc plated finish in quantities to your specification

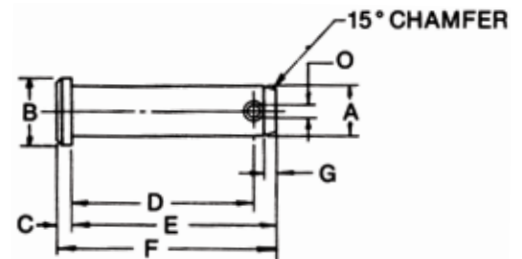

Part No.	A	B	C	D (Min.)	E	F	G	O (Drill No.)	Wt. (lbs.)	Cat.
B27081/22AZ	0.250"	0.375"	0.094"	0.672"	0.797"	0.891"	0.063"	49 (0.073)	0.012	740 (N)
B27081/23AZ	0.313"	0.438"	0.094"	0.813"	0.969"	1.063"	0.078"	38 (0.101)	0.022	740 (N)
B27081/24AZ	0.375"	0.500"	0.125"	0.938"	1.094"	1.219"	0.078"	38 (0.101)	0.09	740 (N)
B27081/26AZ	0.500"	0.625"	0.156"	1.203"	1.359"	1.54"	0.109"	29 (0.136)	0.09	740 (N)
B27081/26C	0.500"	0.625"	0.156"	1.766"	1.984"	2.141"	0.109"	29 (0.136)	0.12	740 (N)
B27081/26D	0.500"	0.625"	0.156"	1.982"	2.203"	2.359"	0.109"	29 (0.136)	0.14	740 (N)
B27081/27AZ	0.625"	0.813"	0.203"	1.469"	1.719"	1.922"	1.141"	29 (0.136)	0.17	740 (N)
B27081/27BZ	0.500"	0.625"	0.156"	1.562"	1.781"	1.938"	0.109"	29 (0.136)	0.09	740 (N)
B27081/27C	0.500"	0.625"	0.156"	1.344"	1.563"	1.750"	0.156"	29 (0.136)	0.09	740 (N)
B27081/28AZ	0.750"	0.938"	0.250"	1.750"	2.047"	2.297"	0.156"	19 (0.166)	0.3	740 (N)
B27081/210C	0.625"	0.813"	0.188"	1.625"	1.750"	1.953"	0.062"	29 (0.136)	0.18	740 (N)
3018488	0.920"	1.180"	0.34"	2.547"	2.75"	3.09"	0.093"	29 (0.136)	0.72	740 (N)



End Rods

Blank Forged Rod End

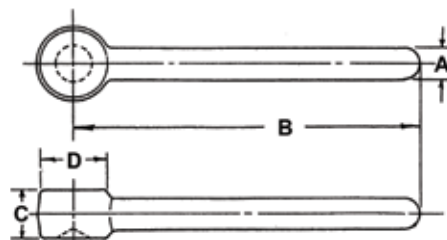

Part No.	Description	A	B	C	D	Wt. (lbs.)	Cat.
B27026EB	Blank Rod End	1/2"	6"	9/16"	3-1/32"	0.44	705 (N)
B27027EB	Blank Rod End	5/8"	6"	11/16"	1-1/4"	0.70	705 (N)
B27028EB	Blank Rod End	3/4"	6"	13/16"	1-1/2"	1.10	705 (N)
B270210EB	Blank Rod End	1"	6"	1-3/32"	2-1/32"	2.11	705 (N)

Forged Rod End

- Machined with NC thread

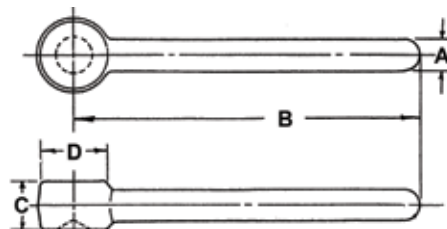

Part No.	Description	A	B	C	D	Wt. (lbs.)	Cat.
B27024BM	Machined with NC Thread Rod End	3/8"	3-1/2"	7/16"	1-1/16"	0.12	705 (N)
B27026BM	Machined with NC Thread Rod End	1/2"	3-1/2"	9/16"	3-1/32"	0.27	705 (N)
B27026EM	Machined with NC Thread Rod End	1/2"	6"	9/16"	3-1/32"	0.34	705 (N)
B27026M10	Machined with NC Thread Rod End	1/2"	10"	9/32"	3-1/32"	0.56	705 (N)
B27027EM	Machined with NC Thread Rod End	5/8"	6"	11/16"	1-1/4"	0.53	705 (N)
B27028EM	Machined with NC Thread Rod End	3/4"	6"	13/16"	1-1/2"	0.88	705 (N)
B270210EM	Machined with NC Thread Rod End	1"	6"	1-3/32"	2-1/32"	1.58	705 (N)
B270212KM	Machined with NC Thread Rod End	1-1/4"	12"	1-1/4"	2-3/8"	4.40	705 (N)

Forged Rod End

- Machined with NC thread
- Zinc plated

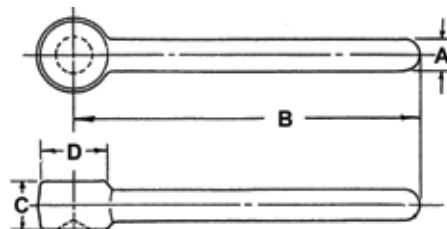

Part No.	Description	A	B	C	D	Wt. (lbs.)	Cat.
B27028LMZ	Machined with NC Thread Rod End	3/4"	7"	1/2"	1-1/2"	1.04	705 (N)
B270210HMZ	Machined with NC Thread Rod End	1"	9-1/4"	1"	2"	2.20	705 (N)

Adjustable Yoke End, Spread

- Machine forged
- Spread
- Fine thread



Part No.	Description	Wt. (lbs.)	Cat.
B27086C	1/2" Adjustable Yoke End, Spread	0.32	730 (N)

Adjustable Yoke End, Straight

- Machine forged
- Meet S.A.E. standards
- Custom sizes & finishes available

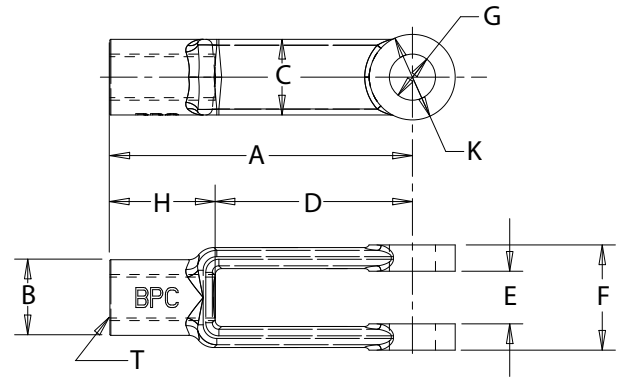

Part No.	A	B	C	D	E	F	G	H	K	T (Thread)	Wt. (lbs.)	Cat.
B27081AZ	1.563"	0.313"	0.313"	1.000"	0.188"	0.438"	0.188"	0.563"	0.375"	3/16-32 NF	0.03	730 (N)
B27082A	2.000"	0.438"	0.438"	1.250"	0.281"	0.625"	0.250"	0.750"	0.500"	1/4-28 NF	0.07	730 (N)
B27082AZ	2.000"	0.438"	0.438"	1.250"	0.281"	0.625"	0.250"	0.750"	0.500"	1/4-28 NF	0.07	730 (N)
B27083A	2.250"	0.500"	0.500"	1.438"	0.344"	0.750"	0.313"	0.813"	0.594"	5/16-24 NF	0.11	730 (N)
B27083AZ	2.250"	0.500"	0.500"	1.438"	0.344"	0.750"	0.313"	0.813"	0.594"	5/16-24 NF	0.11	730 (N)
B27083A14Z	2.250"	0.500"	0.500"	1.438"	0.344"	0.750"	0.313"	0.813"	0.594"	1/4-28 NF	0.11	730 (N)
B27084A	2.500"	0.625"	0.625"	1.625"	0.438"	0.875"	0.375"	0.875"	0.688"	3/8-24 NF	0.17	730 (N)
B27084AZ	2.500"	0.625"	0.625"	1.625"	0.438"	0.875"	0.375"	0.875"	0.688"	3/8-24 NF	0.17	730 (N)
B27084A14Z	2.500"	0.625"	0.625"	1.625"	0.438"	0.875"	0.375"	0.875"	0.688"	1/4-28 NF	0.17	730 (N)
B27084A56ZY	2.500"	0.625"	0.625"	1.625"	0.438"	0.875"	0.375"	0.875"	0.688"	5/16-24 NF	0.17	730 (N)
B27084A12	2.500"	0.625"	0.625"	1.625"	0.438"	0.875"	0.375"	0.875"	0.688"	1/2-20 NF	0.17	730 (N)
B27085A	2.875"	0.719"	0.719"	1.875"	0.500"	1.000"	0.438"	1.000"	0.813"	7/16-20 NF	0.24	730 (N)
B27086ANF	3.000"	0.813"	0.813"	1.875"	0.563"	1.125"	0.500"	1.125"	0.938"	1/2-20 NF	0.39	730 (N)
B27086ANFZ	3.000"	0.813"	0.813"	1.875"	0.563"	1.125"	0.500"	1.125"	0.938"	1/2-20 NF	0.39	730 (N)
B27086ANC	3.000"	0.813"	0.813"	1.875"	0.563"	1.125"	0.500"	1.125"	0.938"	1/2-13 NC	0.39	730 (N)
B27086ANCZ	3.000"	0.813"	0.813"	1.875"	0.563"	1.125"	0.500"	1.125"	0.938"	1/2-13 NC	0.39	730 (N)
B27086A14Z	3.000"	0.813"	0.813"	1.875"	0.563"	1.125"	0.500"	1.125"	0.938"	1/4-28 NF	0.39	730 (N)
B27086A56ZY	3.000"	0.813"	0.813"	1.875"	0.563"	1.125"	0.500"	1.125"	0.938"	5/16-24 NF	0.39	730 (N)
B27086A38ZY	3.000"	0.813"	0.813"	1.875"	0.563"	1.125"	0.500"	1.125"	0.938"	3/8-24 NF	0.39	730 (N)
B27086B	4.188"	0.813"	0.813"	3.063"	0.563"	1.125"	0.500"	1.125"	0.938"	1/2-20 NF	0.39	730 (N)
B27087ANF	4.938"	1.063"	1.063"	3.688"	0.688"	1.375"	0.625"	1.250"	1.188"	5/8-18 NF	0.85	730 (N)
B27087ANFZ	4.938"	1.063"	1.063"	3.688"	0.688"	1.375"	0.625"	1.250"	1.188"	5/8-18 NF	0.85	730 (N)
B27087ANC	4.938"	1.063"	1.063"	3.688"	0.688"	1.375"	0.625"	1.250"	1.188"	5/8-11 NC	0.85	730 (N)
B27087B	4.469"	1.063"	0.750"	3.250"	0.563"	1.438"	0.500"	1.219"	1.063"	5/8-18 NF	0.64	730 (N)
B27087C	1.903"	0.844"	0.847"	1.250"	0.594"	1.281"	0.500"	0.563"	0.969"	5/8-18 NF	0.24	730 (N)
B27088ANF	6.063"	1.250"	1.250"	4.563"	0.813"	1.625"	0.750"	1.500"	1.438"	3/4-16 NF	1.15	730 (N)
B27088ANC	6.063"	1.250"	1.250"	4.563"	0.813"	1.625"	0.750"	1.500"	1.438"	3/4-10 NC	1.15	730 (N)
B270810C	2.313"	1.125"	1.250"	1.500"	0.563"	1.500"	0.625"	0.813"	1.250"	5/8-18 NF	0.68	730 (N)

*LH = Left Hand Thread



Yoke Ends

Adjustable Yoke End



- Machine forged
- Curved

Part No.	Description	Wt. (lbs.)	Cat.
B27087BB	5/8" Adjustable Yoke End, Curved Clevis, 5/8" - 18" unf	0.64	730 (N)
B27086EZ	1/2" Adjustable Yoke End, Curved Clevis, 5/8" - 20" unf	0.50	730 (N)

Offset Yoke End



- Machine Forged

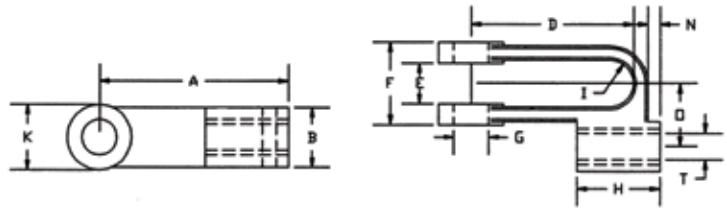

Part No.	A	B	D	E	F	G	H	I	K	N	O	T	Cat.
B26996A	2-1/4"	13/16"	17/8"	9/16"	11/8"	1/2"	11/8"	5/16"	15/16"	1/8"	53/64"	1/2-20 NF	730 (N)

Plain Yoke End



- Meets S.A.E. standard

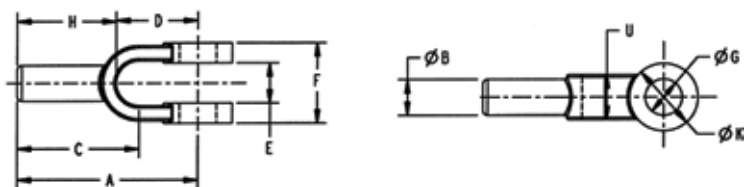

Part No.	A	B	C	D	E	F	G	H	K	U	Wt. (lbs.)	Cat.
B27094A	2-1/8"	3/8"	1-33/64"	2-7/32"	7/16"	7/8"	3/8"	1-1/4"	11/16"	5/8"	0.11	750 (N)
B27096A	2-1/2"	1/2"	1-11/16"	1-1/8"	9/16"	1-1/8"	1/2"	1-3/8"	15/16"	5/8"	0.24	750 (N)
B27097A	4-5/8"	5/8"	3-5/8"	1-7/16"	11/16"	1-3/8"	5/8"	3-1/4"	1-3/16"	1"	0.46	750 (N)

Heavy Duty Friction Stock Bumper



- Reinforced with nylon & rayon cording
- Compression molded
- Sold in pairs

Part No.	Description	Dimensions WxDxH	Hole Spacing (C-C)		Hole Size	Wt. Per Pair (lbs.)	Cat.
			Vertical	Horizontal			
B4000	Heavy Duty Friction Stock Bumper	6" x 3" x 8"	3.25"	5.50"	0.50"	7.60	370 (N)

Precision Molded Rubber Bumper



- Designed for OEM applications where close tolerance & precision molding is mandatory
- Sold in pairs

Part No.	Description	Dimensions WxDxH	Hole Spacing (C-C)		Hole Size	Wt. Per Pair (lbs.)	Cat.
			Vertical	Horizontal			
B4500	Precision Molded Rubber Bumper	5-1/2" x 3-23/32" x 7-5/8"	3.0"	5.50"	0.58"	10.50	370 (N)

Molded Rubber Bumpers



- Sold in pairs

Part No.	Description	Dimensions WxDxH	Hole Spacing (C-C)	Hole Size	Wt. Per Pair (lbs.)	Cat.
			Horizontal			
B5264	Molded Rubber Bumper	2-1/2" x 4-1/8" x 6-3/4"	3.75"	0.53"	6.50	370 (N)

Molded Rubber Bumpers



- Sold in pairs

Part No.	Description	Dimensions WxDxH	Hole Spacing (C-C)	Hole Size	Wt. Per Pair (lbs.)	Cat.
			Horizontal			
B5500	Molded Rubber Bumper	3" x 3-1/2" x 6"	3.00"	0.54"	5.85	370 (N)



Rubber Bumpers

Molded Rubber Bumpers



- Sold in pairs

Part No.	Description	Dimensions WxDxH	Hole Spacing (C-C) Horizontal	Hole Size	Wt. Per Pair (lbs.)	Cat.
B5540	Molded Rubber Bumper	2-9/16" x 3" x 6"	3.50"	0.66"	3.30	370 (N)

Molded Rubber Bumpers



- Sold in pairs

Part No.	Description	Dimensions WxDxH	Hole Spacing (C-C) Horizontal	Hole Size	Wt. Per Pair (lbs.)	Cat.
B5760	Molded Rubber Bumper	2-1/4" x 2" x 7-3/4"	4.63"	0.44"	2.65	370 (N)

Molded Rubber Bumpers



- Sold in pairs

Part No.	Description	Dimensions WxDxH	Hole Spacing (C-C) Horizontal	Hole Size	Wt. Per Pair (lbs.)	Cat.
B6000L	Molded Rubber Bumper	3-1/2" x 3-1/2" x 6"	3.00"	0.56"	6.00	370 (N)

Laminated Rubber Bumpers



- Belted rubber sections encased in structural steel angles with welded tie rods
- Recommended for refuse and severe duty applications
- Weld-on bumper compares to Heil® # H-014-1714

Part No.	Description	Dimensions WxDxH	Wt. Per Pair (lbs.)	Cat.
B9000	Laminated Rubber Bumper	10" x 5" x 2-1/2"	17.50	370 (N)

Extruded Rubber D-Shaped Bumper

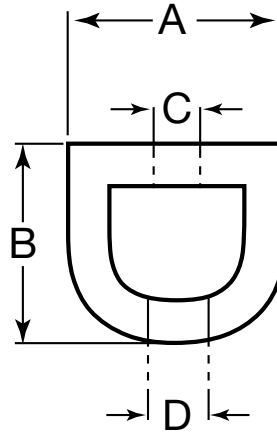

Part No.	A	B	C	D	No. of Holes	C-C of Holes	Length	Wt. (lbs.)	Cat.
D210	2-1/8"	1-7/8"	3/8"	11/16"	2	6"	10"	1.80	370 (N)
D2120	2-1/8"	1-7/8"	N/A	N/A	None	—	120"	21.60	370 (N)
D232	2-1/8"	1-7/8"	3/8"	11/16"	3	14"	32"	5.76	370 (N)
D26U	2-1/8"	1-7/8"	3/8"	11/16"	2	3"	6"	1.08	370 (N)
D312	3"	2-7/8"	11/16"	1-1/8"	2	8-1/8"	12"	3.30	370 (N)
D324	3"	2-7/8"	11/16"	1-1/8"	4	6-1/2"	24"	6.60	370 (N)
D412	4"	3-3/4"	7/8"	1-1/8"	2	7-7/8"	12"	5.50	370 (N)
D424	4"	3-3/4"	7/8"	1-1/8"	3	10"	24"	11.00	370 (N)
D46	4"	3-3/4"	7/8"	1-1/8"	2	3-1/8"	6"	2.75	370 (N)

Extruded Rubber Rectangular Bumper



- Includes steel insert mounting plate

Part No.	Width	Length	Thickness	No. of Holes	C-C of Holes	Wt. (lbs.)	Cat.
441466	4-3/4"	10"	2-3/4"	2	5"	5.45	370 (N)



Products are Retail Packaged



Rubber Bumpers & Suspension Kits

2-1/2" Round Rubber Bumper



- Protects from door handles, latches, and cam locks
- Used as a cushion for loading ramps & lift gates
- Bumper is 1" high

Part No.	Description	Wt. (lbs.)	Cat.
B1001	2-1/2" Bumper, Black	0.18	370 (N)

Cabinet Door Bumper



Part No.	Description	Wt. (lbs.)	Cat.
CDB01	Cabinet Door Bumper	0.01	370 (N)

2" Suspension Leveling Kit for GM® Trucks



- Maintain a level vehicle stance when using a vehicle for front-loaded applications like snow plows
- Retain the vehicle's factory suspension
- Easy to install, with a 2-3 hour installation time (instructions included)
- Anodized aluminum construction increases corrosion resistance

Part No.	Description	Wt. (lbs.)	Cat.
5562112	2" Suspension Leveling Kit for 2007-15 GM 1500 SILVERADO/SIERRA 2WD-4WD	2.5	556 (N)

*See buyersproducts.com for a complete list of vehicles

Auxiliary Front Suspension Kits



- Designed for GM trucks
- Ideal for snowplow applications
- Increases the load carrying ability
- Provides suspension protection for work vehicles
- Adds safety & stability
- Easy to install - complete instructions included
- Contains 2 springs, mounting brackets, hardware

Part No.	Description	Wt. (lbs.)	Cat.
5562001	Auxiliary Front Suspension Kit For GM Trucks*	2.5	556 (N)

*See buyersproducts.com for a complete list of vehicles

Auxiliary Front Suspension Kits



- Designed for GM trucks
- Ideal for snowplow applications
- Increases the load carrying ability
- Provides suspension protection for work vehicles
- Adds safety & stability
- Easy to install - complete instructions included
- Contains 2 springs, mounting brackets, hardware

Part No.	Description	Wt. (lbs.)	Cat.
5562009	Auxiliary Front Suspension Kit For GM Trucks*	2.5	556 (N)

*See buyersproducts.com for a complete list of vehicles

Tie Rod Style Cylinders

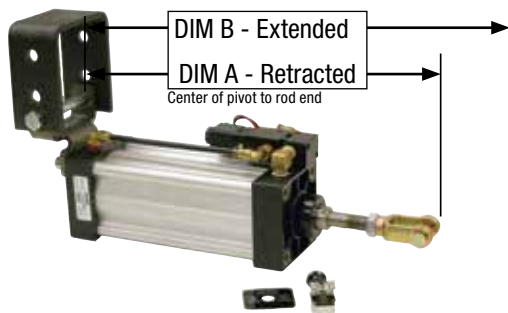

- Extruded aluminum body
- 5/8"-18 Threaded rod
- 1/4" NPT port threads
- 1/2" Clevis mount (removable for hinge mount)
- Pillow valves (prevents piston from hitting inner walls)
- Includes: (2) 1/2" clevis pins; (1) 5/8"-18 threaded adjustable yoke; (2) cotter pins

Features Key

Abbreviation	Features
C	Cylinder Only
V	Clevis Mount
HM	Hinge Mount
K	Manual Air Valve
KSA	Electric Solenoid
SPK	Cylinder Kit

Part NO.	Mount	Stroke	Bore	Dim A	Dim B	Rod Dia	Features	Wt. (lbs.)	Cat.
TGC25006V	Clevis	6	2.5	13.25	19.25	3/4"	V	6.10	512 (N)
TGC25008V	Clevis	8	2.5	15.25	23.25	3/4"	V	6.59	512 (N)
TGC25008VK	Clevis	8	2.5	15.25	23.25	3/4"	V, K	7.10	512 (N)
TGC32506V	Clevis	6	3.25	15.00	21.00	1"	V	9.00	512 (N)
TGC32506VK	Clevis	6	3.25	15.00	21.00	1"	V, K	10.25	512 (N)
TGC32508HM	Hinge	8	3.25	17.00	25.00	1"	HM	13.50	512 (N)
TGC32508HMKSA	Hinge	8	3.25	17.00	25.00	1"	HM, KSA	14.00	512 (N)
TGC32508V	Clevis	8	3.25	17.00	25.00	1"	V	10.50	512 (N)
TGC32508VKSA	Clevis	8	3.25	17.00	25.00	1"	V, KSA	11.50	512 (N)
TGC25008C	Clevis	8	2.5	15.25	23.25	3/4"	V	10	220 (N)
TGC25008HMK	Hinge	8	2.5	15.25	23.25	3/4"	HM, K	10.75	512 (N)

Tie Rod Style Cylinder Kits



- Extruded aluminum body
- 5/8"-18 Threaded rod
- 1/4" NPT port threads
- 1/2" Clevis mount (removable for hinge mount)
- Pillow valves (prevents piston from hitting inner walls)
- Includes: (2) 1/2" clevis pins; (1) 5/8"-18 threaded adjustable yoke; coppers pins, (7) 1/4" male push-on fittings, 75' x 1/4" nylon tubing, (1) BAV020 valve

Features Key

Abbreviation	Features
C	Cylinder Only
V	Clevis Mount
HM	Hinge Mount
K	Manual Air Valve
KSA	Electric Solenoid
SPK	Cylinder Kit

Part NO.	Mount	Stroke	Bore	Dim A	Dim B	Rod Dia	Features	Wt. (lbs.)	Cat.
TGC25006VSPK	Clevis	6	2.5	13.25	19.25	3/4"	V, SPK	10.10	512 (N)
TGC25008VSPK	Clevis	8	2.5	15.25	23.25	3/4"	V, SPK	10.25	512 (N)
TGC32506VSPK	Clevis	6	3.25	15.00	21.00	1"	V, SPK	13.75	512 (N)
TGC32508VSPK	Clevis	8	3.25	17.00	25.00	1"	V, SPK	13.10	512 (N)

COMPARABLE TAILGATE CYLINDERS

BUYERS	APSCO®*	TECHTRAN®*	VELVAC®*
TGC25006V	—	29-250X6	100004, 100123
TGC25008V	C-5070	29-250X8	100007, 100124
TGC32506V	C-6057	29-350X6	100006, 100131
TGC32508V	C-6089	29-350X8	100132, 100136, 100137

* Buyers Products is not authorized by nor affiliated with the manufacturer of APSCO®, TECHTRAN®, or VELVAC® products.

Custom Complete Tailgate Cylinder Kits

- Available by special order
- Contact customer service for more information



Air Valves

4-Way, 2-Position Air Valve



Part NO.	Description	Wt. (lbs.)	Cat.
BAV010	4-Way, 2-Position Air Valve, 1/8" N.P.T. Ports	0.50	645 (N)

4-Way, 3-Position Air Valve



Part NO.	Description	Wt. (lbs.)	Cat.
BAV020	4-Way, 3-Position Air Valve, 1/4" N.P.T. Ports	1.86	645 (N)

4-Way, 3-Position Air Valve



Part NO.	Description	Wt. (lbs.)	Cat.
BAV015	4-Way, 3-Position Air Valve, 1/4" N.P.T. Ports	0.67	645 (N)

4-Way, 2-Position Solenoid Air Valve



Part NO.	Description	Wt. (lbs.)	Cat.
BAV050SA	4-Way, 2-Position Solenoid Valve, 1/4" N.P.T. Ports	1.21	645 (N)

Push-Pull Switch



Part NO.	Description	Wt. (lbs.)	Cat.
BSW050	Push-Pull Switch, for use with BAV050SA	0.20	645 (N)

Dump Body Vibrator Kit

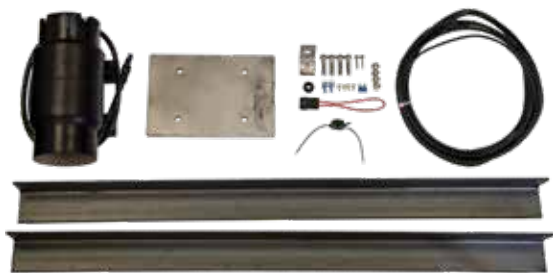

- O-Ring sealed for weather resistance
- Sealed, permanently lubricated bearings
- Hardened steel motor shaft
- Aluminum housing
- **Mounting Kit includes:** 50' 4 AWG wire, solenoid, circuit breaker, push-button switch, steel mounting plate with fasteners

Part NO.	Description	Wt. (lbs.)	Cat.
DBV900	900 lbs. Force 12VDC Vibrator, with mounting kit	60.00	555 (Y)

Dump Body Vibrators



- O-Ring sealed for weather resistance
- Sealed, permanently lubricated bearings
- Hardened steel motor shaft
- Aluminum housing
- **Mounting Kit includes:** 50' 4 AWG wire, solenoid, circuit breaker, push-button switch, steel mounting plate with fasteners

Part NO.	Description	Wt. (lbs.)	Cat.
DBV2500	2,500 lbs. Force 12VDC Vibrator for 9' - 12' Dumps, with mounting kit	60.00	555 (Y)
DBV3500	3,500 lbs. Force 12VDC Vibrator for 13'+ Dumps, with mounting kit	60.00	555 (Y)
3022840	15 Second Vibrator Timer	0.10	555 (Y)
3009253	Alum. Vibrator Mounting Plate for Alum. Dump Bodies	3.50	520 (N)

Inspection Doors



- Designed to be welded into dump body tailgates
- Adjustable door travel clevis & door linkage
- Bolt-on cast iron door handle interchanges for left or right hand operation
- Over-center positive locking handle
- Detent door holder (or positioner)
- Durable carbon steel construction
- Individually boxed
- CCD0714: for 1-ton to super-duty dumps
- CCD1314: for medium & heavy class dumps
- Plain finish for easy installation

Part NO.	Description	Wt. (lbs.)	Cat.
CCD0714SS	Stainless Steel Inspection Door with detent, 7-1/4" T x 13-3/4" W Door opening	35.00	512 (N)
CCD0714	Inspection Door with detent, 7-1/4" T x 13-3/4" W Door opening	40.50	512 (N)
CCD1314	Inspection Door with detent, 12-3/8" T x 13-1/2" W Door opening	49.50	512 (N)
3015862	Replacement Handle for CCD0714	3.00	512 (N)
3015863	Replacement Handle for CCD1314	2.76	512 (N)



Shovel Holder, Hinge Assemblies, Tailgate Hardware

Shovel Holder for Trucks



- HD spring mechanism secures shovel or other round handled tool
- Ideal for dump body applications
- Stainless steel or carbon steel with black powder coat finish

Part NO.	Description	Wt. (lbs.)	Cat.
SH675	Shovel Holder, Carbon Steel Black Powder Coat Finish	2.75	520 (N)
SH675SS	Shovel Holder, Stainless Steel	2.75	520 (N)

Dump Lower Hinge Assembly



- Heavy duty forged latch with thicker rib design
- For 1" & 1-1/4" dia. tailgate posts
- Bases are forged from C1020 steel for ease of welding
- Forged C1045 steel latches offer increased strength and ductility over cast products
- Custom pin holes & grease fittings are available as special orders

Part NO.	Description	Wt. (lbs.)	Cat.
BTL020B2	2-1/2" wide Lower Hinge Assy., (1/2" pin hole) for 1" dia. post	6.00	512 (N)
BTL030B2	2-1/2" wide Lower Hinge Assy., (1/2" pin hole) for 1-1/4" dia. post	6.00	512 (N)
BTL030B656	2-1/2" wide Lower Hinge Assy., (21/32" pin hole) for 1-1/4" dia. post	6.00	512 (N)
BTL030M2	4" wide Lower Hinge Assy., (1/2" pin hole) for 1-1/4" dia. post	6.85	512 (N)
B284001	1/2" Tailgate Pin Replacement, Zinc	0.35	520 (N)
HP10	1/8" Hairpin Cotter Replacement, Zinc	0.04	520 (N)

Upper Tailgate Bracket



- Bracket comes complete with 1/2" diameter "L" pin and hairpin cotter
- Available for use with 1-1/4" and 1-1/2" diameter tailgate posts

Part NO.	Description	Wt. (lbs.)	Cat.
BTB030	Fits 1-1/4" dia. Tailgate Posts	3.10	512 (N)
B284001	1/2" Tailgate Pin Replacement, Zinc	0.35	520 (N)
HP10	1/8" Hairpin Cotter Replacement, Zinc	0.04	520 (N)

Tailgate Latch Assembly

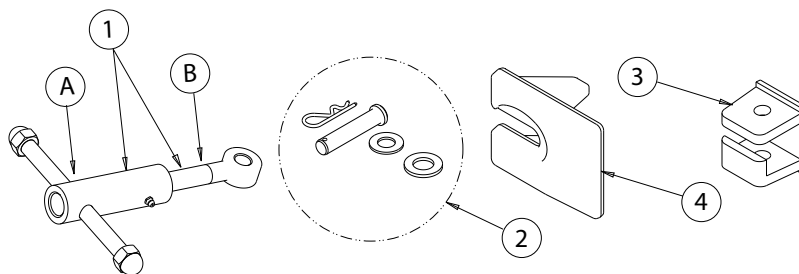

- The zinc plated bar assembly constructed of A-36 steel, with forged rod end & bracket for ease of use & strength of operation
- The latch assembly can be used to provide a seal for dump body and dump trailer tailgates
- Available in steel, stainless steel or aluminum

Part NO.	Diagram NO.	Description	Wt. (lbs.)	Cat.
TGL3410ST	-	Steel Tailgate Latch Assembly with Forged Bracket & Clevis	10.33	520 (N)
TGL3410	-	Steel Tailgate Latch Assembly with Alum. Bracket & Clevis	6.00	520 (N)
TGL3410SS	-	Stainless Steel Tailgate Latch Assembly with SS Bracket & Clevis	10.40	520 (N)
TGL34SBR	(1)	Steel Latch Bar Assembly for Tailgate Latch	3.40	520 (N)
TGL34SB	(A)	Steel Bar Winder Only	2.40	520 (N)
B27028LMZ	(B)	Rod End Only, 3/4"-10 x 7-1/2"	1.05	705 (N)
TGL3410HDW	(2)	Hardware Kit for Tailgate Latches	0.40	520 (N)
TGL34CLCS	(3)	Cast Steel Clevis for Tailgate Latch	1.27	520 (N)
TGL34CL	(3)	Aluminum Clevis for Tailgate Latch	0.60	520 (N)
TGL34CLSS	(3)	Stainless Steel Clevis for Tailgate Latch	1.81	520 (N)
TGL34BKTF	(4)	Forged Bracket, Tailgate Latch, Steel	3.00	520 (N)
TGL34BKT	(4)	Bracket, Tailgate Latch, Aluminum	1.60	520 (N)
TGL34BKTSS	(4)	Bracket, Tailgate Latch, Stainless Steel	0.44	520 (N)

Tailgate Release Lever



- Ductile iron release lever slides over 1" dia. cross shaft & bolts to adapter plate for 2 point attachment
- Adapter is designed to weld to 1" dia. cross shaft to provide mounting point for L001 tailgate release lever
- L001C sold separately

Part NO.	Description	Wt. (lbs.)	Cat.
L001	Tailgate Release Lever	6.80	512 (N)
L001C	Tailgate Release Lever Cam	0.7	512 (N)

Welded Ring with Chain



- 1/4" stock 2-3/4" O.D. ring
- Use with tailgate release lever
- Available in plain, zinc, or stainless steel

Part NO.	Description	Wt. (lbs.)	Cat.
58R5	5 Links of Chain	0.26	512 (N)
58R5SS	5 Links of Chain, Stainless Steel	0.28	512 (N)
58R5Z	5 Links of Chain, Zinc	0.26	512 (N)
58R6	6 Links of Chain, Zinc	0.40	512 (N)
58R14	14 Links of Chain	0.57	512 (N)



Tailgate Latch & Lever

Tailgate Linkage Connecting Plate



- Stamped from 1/2" steel plate
- Other sizes available by special order

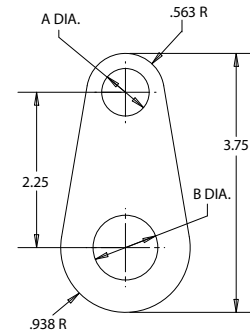

Part NO.	A Dia.	B Dia.	Wt. (lbs.)	Cat.
TGCAM0001	5/8"	1-1/4"	0.60	512 (N)
TGCAM0002	1/2"	1"	0.60	512 (N)
TGCAM0003	5/8"	1"	0.60	512 (N)
TGCAM0004	1/2"	1-1/4"	0.60	512 (N)

Banjo Eye



TGB3125

- Available in stamped steel or stainless steel
- For dump tailgates and load securing applications
- Other thicknesses and configurations available by special order

Part NO.	Description	Wt. (lbs.)	Cat.
TGBE3125	Banjo Eye, Steel (for 5/16" chain), 3.56" x 3.5" x 0.3125"	0.87	512 (N)
TGBE3138	Banjo Eye, Steel (for 3/8" chain), 3.56" x 3.5" x 0.3125"	0.78	512 (N)
TGBE6438	Banjo Eye, Stainless Steel (for 3/8" chain) 6.0"x 4.3" x 0.375"	2.39	903-5 (N)

Cruciform Chain Bracket



- Ideal for securing dump truck tailgates
- Chain stays secure via the unique cruciform design
- Ideal latch point for a variety of load securing applications

Part NO.	Description	Wt. (lbs.)	Cat.
SC450C	4" x 5-1/2" x 1/2" Thick Steel Tubing	9.02	547 (N)

Chain Latch



- Formed from 3/8" steel
- Provides a latch point for safety chains up to 3/8" in size

Part NO.	Description	Wt. (lbs.)	Cat.
CL375	Chain Latch	1.25	512 (N)

Nylon Tube and Fitting Installation Kit



- 3/8" x 100' D.O.T. approved nylon tube, (4) 3/8" x 1/4" push-in elbows, (1) 3/8" x 1/4" swivel elbow
- These kits contain all material required to install 2½" or 3-1/4" cylinders using the BAV010, BAV020 air valves

Part NO.	Description	Wt. (lbs.)	Cat.
TGC02TFK	Tube and Fitting Installation Kit (3/8" tube)	2.50	649 (N)

Reducer Bushings



- Brass Bushings

Part NO.	Description	Wt. (lbs.)	Cat.
RAB038025	Brass 3/8" x 1/4" Reducer Bushing	0.04	649 (N)
RAB050038	Brass 1/2" x 3/8" Reducer Bushing	0.05	649 (N)

NPT Breather Vent



- Pneumatic Breather Vent
- Max Pressure 150 PSI
- Max Temp 300 F
- 40 Microns

Part NO.	Description	Wt. (lbs.)	Cat.
BAV01502	1/8" N.P.T. Breather	0.02	649 (N)
BAV02002	1/4" N.P.T. Breather	0.02	649 (N)

Dump Body-Up Indicator Kit



- Tells the driver when the dump body is in the raised position reducing the chance of overhead collisions with raised dump bodies
- **Kit Includes:** Weather Tight Switch, 20' Wiring Harness, Packard Weatherproof Connectors, Body and Chassis Mounting Brackets, Red Indicator Light and In-Cab Indicator Decal (SK12 includes BL10 buzzer light)

Part NO.	Description	Wt. (lbs.)	Cat.
SK10	Body-Up Indicator Kit	1.40	639 (N)
SK12	Body-Up Indicator Kit with BL10 Buzzer Light	1.70	639 (N)



Body-Up Indicators

Dump Body-Up Indicator



- 360° Activation
- Water resistant
- Includes bracket & wiring plug
- Adjustable wand
- 12 VDC, 15 AMPs
- Normally closed

Part NO.	Description	Wt. (lbs.)	Cat.
B95	Body-Up Indicator, 15 AMP	0.80	888 (N)

Prewired Dump Body-Up Indicator



- 360° Activation
- Water resistant
- Includes bracket & wiring plug
- Adjustable wand
- 12 VDC, 15 AMPs
- Normally closed

Part NO.	Description	Wt. (lbs.)	Cat.
B95W	Body-Up Indicator, Prewired, 15 AMP	0.80	888 (N)

Dump Body-Up Indicator Kit



- 360° Activation
- Water resistant
- Includes bracket & wiring plug
- Adjustable wand
- 12 VDC, 15 AMPs
- Normally closed

Part NO.	Description	Wt. (lbs.)	Cat.
SK11	Body-Up Indicator Kit, Prewired with Packard connector, 15 AMP, with Harness & Light	1.11	639 (N)

Compact Style Dump Body-Up Indicator Kit



- Waterproof, IP68 rated
- 304SS housing with adj. mounts
- Operates in extreme temps: -40°F - 185°F
- 12-24 VDC, 5 AMPs
- Normally closed, no polarity
- 2-1/4"L x 7/8"W x 2-1/4"H
- Kit Includes: B96W Indicator, 20' Wiring Harness, Red Indicator Light and In-Cab Indicator Decal (SK16 includes BL10 buzzer light)

Part NO.	Description	Wt. (lbs.)	Cat.
SK14	Body-Up Indicator Kit, 5 AMP	1.0	639 (N)
SK16	Body-Up Indicator Kit, 5AMP, with BL10 Buzzer Light	1.0	639 (N)

Compact Style Dump Body-Up Indicator



- Waterproof, IP68 rated
- 304SS housing with adj. mounts
- Operates in extreme temps: -40°F - 185°F
- 12-24 VDC, 5 AMPs
- Normally closed, no polarity
- 2-1/4"L x 7/8"W x 2-1/4"H
- Ideal for use with BL10 buzzer light

Part NO.	Description	Wt. (lbs.)	Cat.
B96W	Body-Up Indicator, Prewired, 5 AMP	0.20	639 (N)

Buzzer light



- Combination warning light & buzzer operate simultaneously for 2-way warning of hazardous conditions.
- 12 VDC, .2 AMPs
- Red lens, snaps out for easy bulb replacement (bulb included)
- 70 DB at 3 ft.

Part NO.	Description	Wt. (lbs.)	Cat.
BL10	Buzzer Light	0.16	639 (N)

HYDRAULICS

From reservoirs to power take off equipment, we have a complete line of fluid powered products.

CENTRAL HYDRAULIC SYSTEMS	I2
RESERVOIRS	I4
NEW 50 Gallon Side Mount Aluminum Reservoir with Rear Ports	I4
WETLINE KITS	I12
WELDING FLANGES	I14
RESERVOIR ACCESSORIES	I15
NEW Poly Filler-Strainer Breather Cap Assembly with Chrome Cap	I15
GAUGES AND SENSOR KITS	I17
RETURN LINE DIFFUSERS AND STRAINERS	I19
PTOS	I20
PUMPS	I21
MOTORS	I25
DC POWER UNITS	I27
VALVES	I30
COUPLERS	I38
HOSES AND HOSE ACCESSORIES	I41
FILTERS AND FILTER KITS	I42
CLAMPS	I48
FITTINGS	I51
SWIVEL ADAPTERS	I56



Central Hydraulic Systems

15 Gallon Central Hydraulic Systems

(Available with Garmin® GPS Ground Speed Control*)

SPREADER CONTROLS:

- Ground speed spreader control provides proportional spreader operation
- Garmin® GPS antenna provides exceptional spreader response & material savings
- Controller automatically switches to manual mode if signal is interrupted and back to auto mode when regained
- Compact, 3-Function spreader controller (Auger-Conveyor, Spinner & Pre-wet)
- LED display, indexed dials, programmable blast (1-30 seconds) and low pressure pre-wet indicator

DUMP HOIST AND PLOW CONTROLS:

- 11 GPM, 3-Way plow lift/4-way plow angle with 2 cross-over port reliefs/4-Way DA dump hoist with down-port relief and power beyond
- 30 GPM, adjustable flow divider
- Plow switch is detented to provide float in down position
- Hoist safety interlock system

15 GALLON RESERVOIR WITH VALVE ENCLOSURE

- 304 Stainless steel construction
- In-tank return line filter, stainless strainer, poly breather-filler and shielded sight-temperature gauge, with stainless steel mounts
- Bottom ported valves eliminates excess plumbing
- Pre-Plumbed for simpler installation

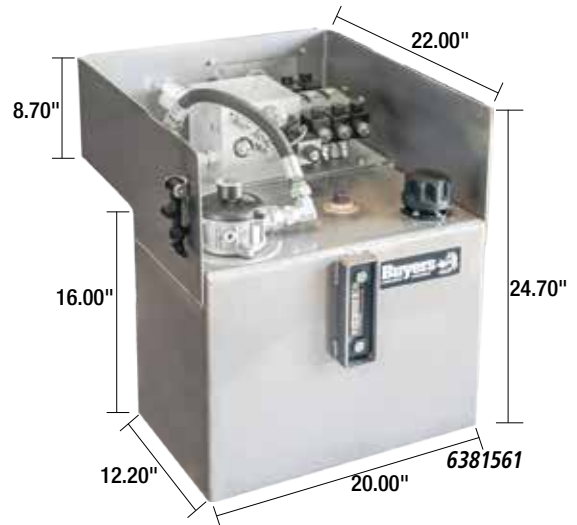

Part No.	Description	Wt. (lbs.)	Cat.
6381540	Central Hydraulic System, 15 Gallon, 4-Function	179.3	638 (N)
6381540 Contains:			
3030859	Wire Harness, 15', For HVE 1 Spool Valve	1.4	639 (N)
3030861	Switch Box for HVE 1 Spool Valve	0.98	639 (N)
HVC05	Electric/Hydraulic Spreader Controller	2	639 (N)
TFAN3	Polymer Filler-Strainer Breather Cap Assembly	0.56	639 (N)
LDR02A	Polycarbonate Oil Level Gauge With Temperature Indicator	0.4	639 (N)
HFA91025	26 GPM In-Tank Filter 1" NPT/10 Micron/25 PSI Bypass	2.8	639 (N)
HVH15	Wire Harness, 15' Valve Side	1.02	639 (N)

Part No.	Description	Wt. (lbs.)	Cat.
6381541*	Central Hydraulic System, 15 Gallon, 4-Function with GPS Ground Speed Control	180	638 (N)

Contains everything from 6381540 (except HVC05) as well as:

GPS1	Garmin® GPS Unit With Converter And Connector	0.6875	639 (N)
HVC06	Electric/Hydraulic Spreader Controller, with Ground Speed Input	2.5	639 (N)

Part No.	Description	Wt. (lbs.)	Cat.
6381560	Central Hydraulic System, 15 Gallon, 6-Function	193.3	638 (N)
6381560 Contains:			
HVESB	Switch Panel, Electrically Operated Sectional Valve	1.4	639 (N)
HVC05	Electric/Hydraulic Spreader Controller	2	639 (N)
TFAN3	Polymer Filler-Strainer Breather Cap Assembly	0.56	639 (N)
LDR02A	Polycarbonate Oil Level Gauge With Temperature Indicator	0.4	639 (N)
HFA91025	26 GPM In-Tank Filter 1" NPT/10 Micron/25 PSI Bypass	2.8	639 (N)
HVH15	Wire Harness, 15' Valve Side	1.02	639 (N)

Part No.	Description	Wt. (lbs.)	Cat.
6381561*	Central Hydraulic System, 15 gal., 6-Function with GPS Ground Speed Control	180	638 (N)

Contains everything from 6381560 (except HVC05) as well as:

GPS1	Garmin® GPS Unit With Converter And Connector	0.6875	639 (N)
HVC06	Electric/Hydraulic Spreader Controller, with Ground Speed Input	2.5	639 (N)



HVESB



HVC05



HVC06



GARMIN.
GPS1

30 Gallon Central Hydraulic Systems

(Available with Garmin® GPS Ground Speed Control*)

SPREADER CONTROLS:

- Ground speed spreader control provides proportional spreader operation
- Garmin® GPS antenna provides exceptional spreader response & material savings
- Controller automatically switches to manual mode if signal is interrupted and back to auto mode when regained
- Compact, 3-Function spreader controller (Auger-Conveyor, Spinner & Pre-wet)
- Color, TFT-LCD touch screen display, programmable blast (1-30 seconds) and low pressure pre-wet indicator

DUMP HOIST AND PLOW CONTROLS:

- 10 GPM, 4-Way plow lift/4-way plow angle with 2 cross-over port reliefs/4-Way DA dump hoist with down-port relief and power beyond
- 30 GPM, 4-way DA dump hoist with down-port relief
- Hoist safety interlock system
- Proportional pneumatic hoist and plow controls
- Adjustable console and base

30 GALLON RESERVOIR WITH VALVE ENCLOSURE

- 304 Stainless steel construction
- In-tank return line filter, stainless strainer, rust-free breather-filler and shielded sight-temperature gauge
- Bottom ported valves eliminates excess plumbing
- Pre-Plumbed for simpler installation

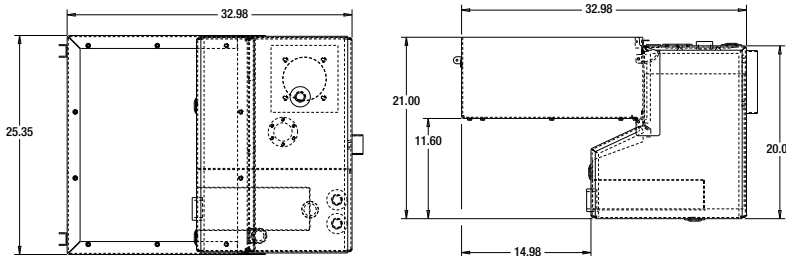

Optional 8-function "Smart Switch" panel with backlit legends, LED indicator lights and 15 amps load rating per switch (Part No. 6391308)

Adjustable Height Control Console and Stand



HVC06T- 4.3" Touch Screen



GARMIN
GPS1

Part No.	Description	Wt. (lbs.)	Cat.
6383060	Central Hydraulic System, 30 gal., 6-Function, Elec./Air, Controls & Stand	200	638 (N)

6383060 Contains:

HVC06T	Controller, Touch Screen	2.5	639 (N)
HFA52525	50 GPM In-Tank Filter 1-1/4"NPT/25 Micron/25 PSI Bypass	6.07	639 (N)
SW2002003	Thru-Wall Tank Strainer 2"NPT Male Thread To 2" NPT Port Thread	1.2	639 (N)
BTI15P	Gauge, Pressure 1-1/2" DIAL 1/8	0.12	639 (N)
K70FDA	Valve, Dual Axis, Feather, Non-Disengaged	8	639 (N)
K70DFD	Single Lever Air Control Valve -Hoist Feather Down Center Detent	3	639 (N)
SK12	Body-Up Indicator Kit	1.7	639 (N)
HVH25	Wire Harness, 25', Valve Side with Auger- 6 Conductor Reverse	2	639 (N)
6451005	Pressure Protection Air Valve, 70 PSI	0.53	639 (N)
TFAN3	Polymer Filler-Strainer Breather Cap Assembly	0.56	639 (N)

Part No.	Description	Wt. (lbs.)	Cat.
6383061*	Central Hydraulic System, 30 gal., 6-Function with GPS Ground Speed Control, Elec./Air, Controls & Stand	180	638 (N)

Contains everything from 6383060 as well as:

GPS1	Garmin® GPS Unit With Converter And Connector	0.6875	639 (N)
-------------	---	--------	---------

Part No.	Description	Wt. (lbs.)	Cat.
6391308	Optional Switch Panel, 8-Function, Programmable, for 6383060 and 6383061	1.68	638 (N)

Reservoirs

35, 50 and 70 Gallon Side Mount Cylindrical Aluminum Reservoirs



SMC35A

- 2" NPT suction return/ports at six o'clock position on tank ends
- 1/2" NPT port/drain on bottom
- Includes a 1/4 turn filler breather unit with basket strainer
- 11 gauge shell .118 thick, 12 gauge heads .100 thick
- Brackets & 24" insulators are included
- 2" wide stainless steel straps

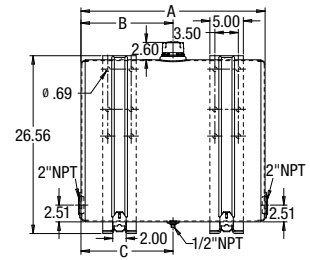
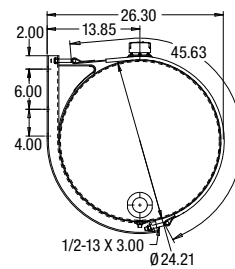

Part No.	Description	A	B	C	Usable Capacity	Wt. (lbs.)	Cat.
SMC35A	35 Gallon Aluminum	19.25	9.63	9.63	29.0 gal.	74	638 (N)
SMC50A	50 Gallon Aluminum	27.50	13.75	13.75	42.0 gal.	77	638 (N)
SMC70A	70 Gallon Aluminum	39.50	19.75	19.75	60.0 gal.	83.5	638 (N)

50 Gallon Side Mount Aluminum Reservoir with Rear Ports



- Features dual rear 2 in. NPT suction/return ports for clean routing
- Durable, light-weight aluminum construction is extremely corrosion resistant and looks like a natural extension of your truck
- Internally baffled to reduce sloshing
- Versatile reservoir works for many hydraulic/fluid storage applications
- Heavy duty mounting brackets wrap underneath the tank for superior stability and support
- Insulated 2" stainless steel mounting straps, temperature/level gauge, and Chrome-Plated Polymer Filler-Strainer Breather Cap included

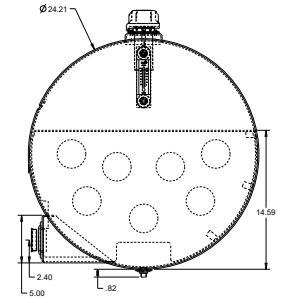
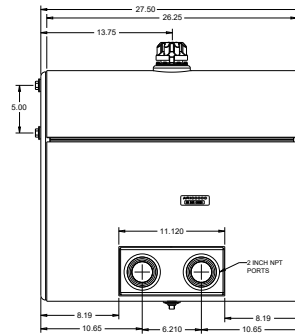

Part No.	Description	A	B	C	Usable Capacity	Wt. (lbs.)	Cat.
NEW SMC50AR	50 Gallon Aluminum	27.50	13.75	13.75	42 gal.	74	638 (N)

50 Gallon Upright Polymer Reservoir



- Reinforced high density polyethylene
- Dual 2" NPT ports (bottom)
- Heavy duty strapless hold down system
- Screw-in diffuser (2" - 1-1/4")
- Sight/temperature gauge included
- Chain mounted 40 micron filler/breather cap included

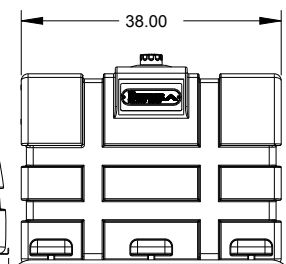
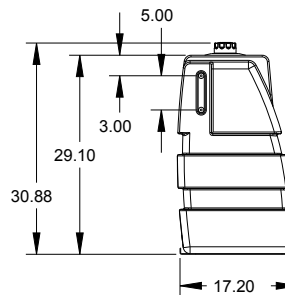

Part No.	Description	Usable Capacity	Wt. (lbs.)	Cat.
UR50P	50 Gallon Polymer	50-55 gal.	102	638 (N)

50 and 70 Gallon Upright Steel Reservoirs



- 12 gauge steel construction
- Fully baffled
- 2" and 1-1/4" NPT ports (bottom)
- 1/4 turn filler/breather unit
- Sight/temperature gauge included
- Includes hardware mounting kit

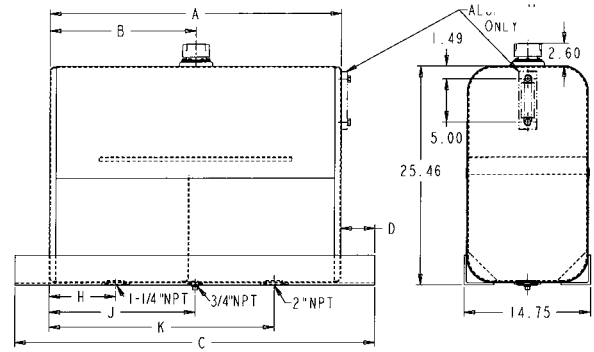

Part No.	Description	A	B	C	D	H	J	K	Usable Capacity	Wt. (lbs.)	Cat.
UR50S	50 Gallon Steel	34.00	17.00	42.00	4.00	7.75	17.00	26.25	50 gal.	157	638 (N)
UR70S	70 Gallon Steel	49.25	24.62	53.75	2.25	16.62	24.62	32.62	67.5 gal.	206	638 (N)
UR50MK	Replacement Spring Mount Kit for UR50S									1.6	638 (N)

35 and 50 Gallon Upright Aluminum Reservoirs



- High-quality aluminum construction
- Fully baffled
- Chrome filler/breather cap
- Diamond tread finish on top half
- Sight/temperature gauge included
- Includes hardware mounting kit

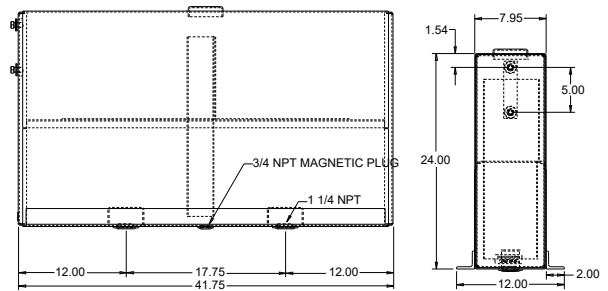

Part No.	Description	Usable Capacity	Wt. (lbs.)	Cat.
UR35A	35 Gallon Aluminum	35 gal.	69	638 (N)
UR50A	50 Gallon Aluminum	50 gal.	69	638 (N)
UR50MK	Replacement Spring Mount Kit for UR50A		1.6	638 (N)

70 Gallon Upright Aluminum Reservoir



- High-quality aluminum construction
- Fully baffled
- Chrome filler/breather cap
- Diamond tread finish on top half
- Tray with strap
- Sight/temperature gauge included
- Includes hardware mounting kit

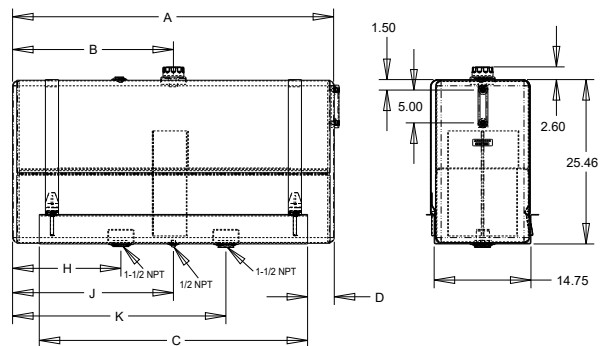

Part No.	Description	A	B	C	D	H	J	K	Usable Capacity	Wt. (lbs.)	Cat.
UR70A	70 Gallon Aluminum	49.25	24.62	53.75	2	16.62	24.62	32.62	67.5 gal.	145	638 (N)

Reservoirs

36 Gallon Steel Bulkhead Reservoirs



BH36SF10

- 12 gauge steel construction
- 10 or 25 micron in-tank return line filter
- (2) 2" NPT suction ports (on each side)
- (1) 100 mesh (150 micron) stainless steel strainer
- Internal baffles
- Nylon filler strainer-breather cap with 30 mesh strainer
- 1" built-in sight gauge standard with ports for optional LDR02A sight-temperature gauge
- (2) 0.824" diameter for through-tank mounting bolts
- 5/8" chain lifting loop

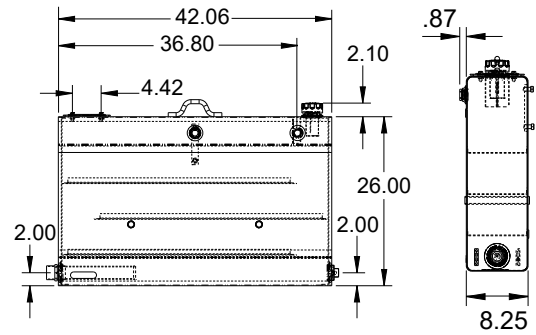

Part No.	Description	Usable Capacity	Wt. (lbs.)	Cat.
BH36SF10	36 Gallon Steel Bulkhead Reservoir with 10 Micron Filter	30.0 gal.	132	638 (N)
BH36SF25	36 Gallon Steel Bulkhead Reservoir with 25 Micron Filter	30.0 gal.	132	638 (N)

50 Gallon Side Mount Polymer Reservoir



- Heavy duty poly (.375" min. thickness)
- 1/4 turn 40 micron chrome filler cap
- Sight level/thermometer gauge
- Fully baffled
- Hardware & brackets included
- 2" wide stainless steel straps

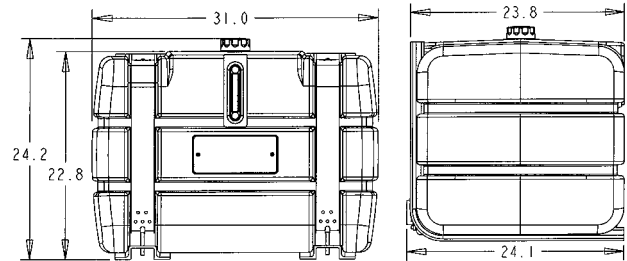

Part No.	Description	Usable Capacity	Wt. (lbs.)	Cat.
SMR50P	50 Gallon Polymer	37.0 gal.	76	638 (N)

50 and 70 Gallon Side Mount Steel Reservoir



SMS50S

SMS005BK

- 13 gauge steel construction
- Fully baffled
- 2" NPT return port/drain on bottom
- Includes a 1/4 turn filler breather unit
- Sight level/thermometer gauge
- **Bracket Kit sold separately**
- 2" wide stainless steel straps

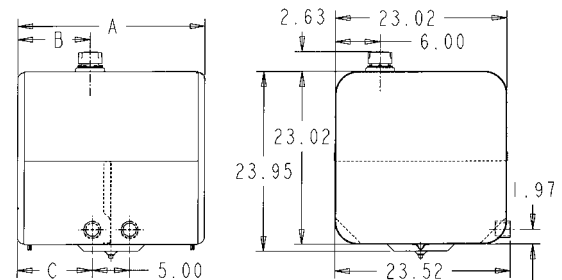

Part No.	Description	A	B	C	Usable Capacity	Wt. (lbs.)	Cat.
SMS50S	50 Gallon Steel	25.00	9.63	10.00	44.0 gal.	108	638 (N)
SMS70S	70 Gallon Steel	35.00	14.63	15.00	61.0 gal.	134	638 (N)
SMS005BK	Side Mount Bracket Kit, for SMS50S & SMS70S					49.1	120 (N)

37 Gallon Steel Reservoir



- 12 gauge H.R.P.O. steel construction
- Welded mounting angles
- 1/4 turn chrome filler breather with wire basket strainer
- Sight level gauge
- Interior baffle between suction and discharge
- Large 2" NPT suction port & 1-1/4" NPT return
- Magnetic drain plug with sump
- Fully tested
- 3/4" NPT load sensing pump drain port
- Clean out cover standard
- Accepts tank mounted HFA5 series return filters

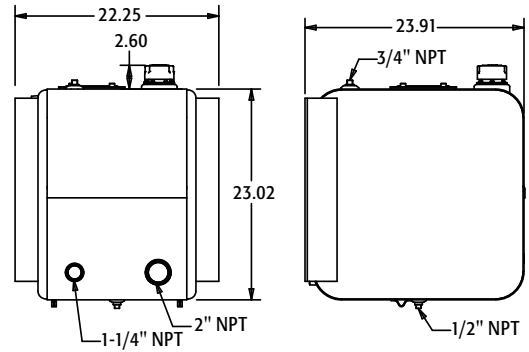

Part No.	Description	Usable Capacity	Wt. (lbs.)	Cat.
SMR37S	37 Gallon Steel	37.0 gal.	103	638 (N)

30 Gallon Steel Reservoir



- 13 gauge H.R.P.O. steel, factory painted or primed
- Welded mounting angles
- 1/4 turn chrome filler breather with basket strainer
- Oil level gauge with temperature indicator
- Interior baffle between suction and discharge
- Large 2" NPT suction ports
- Magnetic drain plug
- Fully tested
- Top drain port
- Port to accommodate breather monitor kit & fluid level gauge

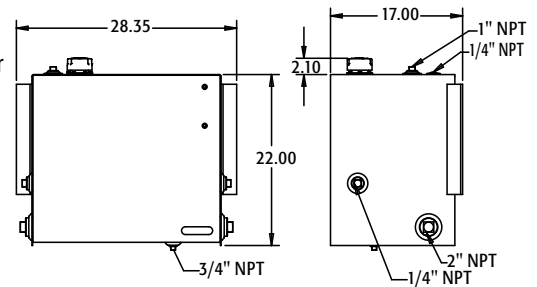

Part No.	Description	Usable Capacity	Wt. (lbs.)	Cat.
SMR30S	30 Gallon Steel	30.0 gal.	84	638 (N)

30 Gallon Stainless Steel Reservoir



SMR30SS

- 304 stainless steel construction
- Welded carbon steel mounting brackets
- 1/4 turn chrome filler breather with basket strainer
- Oil level gauge with temperature indicator
- Interior baffle between suction and discharge
- 1-1/4" NPT suction port
- Magnetic drain plug
- Fully tested
- Pre drilled for HFA5 series tank mounted filter, included with SMR30SS10 or SMR30SS25 (shipped separately)
- Can be shipped UPS

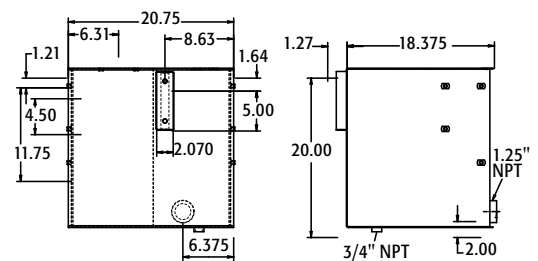

Part No.	Description	Usable Capacity	Wt. (lbs.)	Cat.
SMR30SS	30 Gallon Stainless Steel, without Filter	30.0 gal.	74	638 (N)
SMR30SS10	30 Gallon Stainless Steel, with 10 Micron Filter	30.0 gal.	82	638 (N)
SMR30SS25	30 Gallon Stainless Steel, with 25 Micron Filter	30.0 gal.	82	638 (N)

Reservoirs

25 Gallon Aluminum Reservoirs



SMR25AF10

- .125 thick smooth aluminum
- Aluminum welded mounting angles
- 1/4 turn chrome filler breather with basket strainer
- Oil level gauge with temperature indicator
- Interior baffle between suction and discharge
- Large 2" NPT suction ports, 1-1/4" NPT return port
- Magnetic drain plug
- Fully tested
- Pre drilled for tank mounted filter, included with HFA91025 or HFA92525 (shipped separately)
- Can be shipped U.P.S.

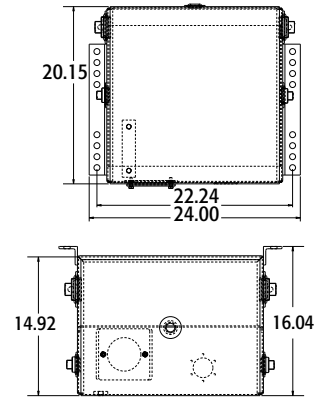

Part No.	Description	Usable Capacity	Wt. (lbs.)	Cat.
SMR25AF10	25 Gallon Aluminum, with 10 Micron Filter	18.0 gal.	43	638 (N)
SMR25AF25	25 Gallon Aluminum, with 25 Micron Filter	18.0 gal.	43	638 (N)

25 Gallon Side Mount Polymer Reservoir



- Heavy duty poly (.375" min. thickness)
- 1/4 turn 40 micron chrome filler cap
- Fluid sight level/thermometer gauge
- Easily adapts to 2 or 3 lines for most dump trailer applications
- Mounting hardware included

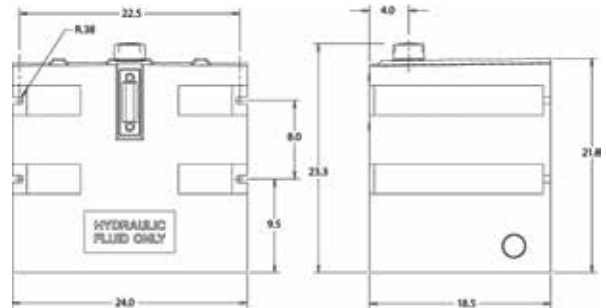

Part No.	Description	Usable Capacity	Wt. (lbs.)	Cat.
SMR25P	25 Gallon Side Mount Poly Reservoir	25.0 gal.	43	638 (N)

25 Gallon Steel Reservoirs



SMR25SF10

- 13 gauge H.R.P.O. steel construction
- Welded mounting angles
- 1/4 turn chrome filler breather with basket strainer
- Oil level gauge with temperature indicator
- Interior baffle between suction and discharge
- Large 2" NPT suction/return ports & 1.25" suction/return ports
- Magnetic drain plug
- Pre drilled for tank mounted filter, included with HFA91025 or HFA92525 (shipped separately)
- Can be shipped U.P.S.

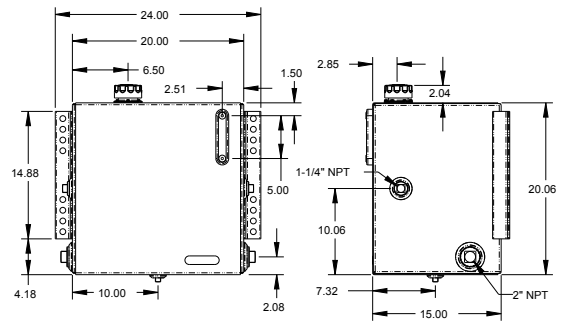

Part No.	Description	Usable Capacity	Wt. (lbs.)	Cat.
SMR25SF10	25 Gallon Steel, with 10 Micron Filter	18.0 gal.	73	638 (N)
SMR25SF25	25 Gallon Steel, with 25 Micron Filter	18.0 gal.	73	638 (N)

25 Gallon Steel Reservoir



- 13 gauge H.R.P.O. steel construction
- Welded mounting angles
- 1/4 turn chrome filler breather with strainer
- Oil level gauge with temperature indicator
- Interior baffle between suction and discharge
- Large 2" NPT suction/return ports & 1.25" suction/return ports
- Magnetic drain plug
- Can be shipped UPS

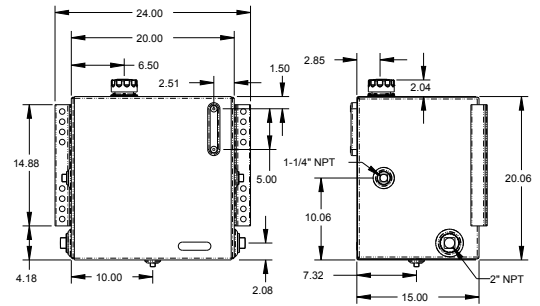

Part No.	Description	Usable Capacity	Wt. (lbs.)	Cat.
SMR25S	25 Gallon Steel	18.0 gal.	71.00	638 (N)

15 Gallon Steel Reservoirs



SMR15SF10

- 13 gauge H.R.P.O. steel construction
- Welded mounting angles
- 1/4 turn chrome filler breather with strainer
- Oil level gauge with temperature indicator
- Interior baffle between suction and discharge
- Large 2" NPT suction/return ports & 1.25" suction/return ports
- Pre drilled for tank mounted filter, included with HFA91025 or HFA92525 (shipped separately)
- Magnetic drain plug
- Can be shipped U.P.S.

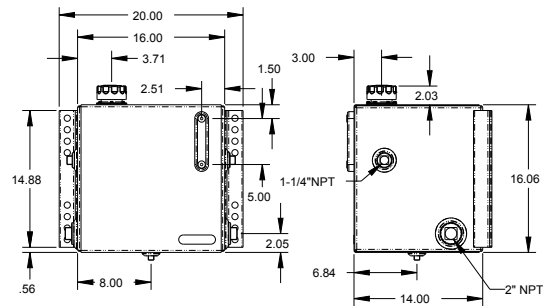

Part No.	Description	Usable Capacity	Wt. (lbs.)	Cat.
SMR15SF10	15 Gallon Reservoir, Steel, with 10 Micron Filter	11.0 gal.	62.0	638 (N)
SMR15SF25	15 Gallon Reservoir, Steel, with 25 Micron Filter	11.0 gal.	62.0	638 (N)

15 Gallon Steel Reservoir



- 13 gauge H.R.P.O. steel construction
- Welded mounting angles
- 1/4 turn chrome filler breather with strainer
- Oil level gauge with temperature indicator
- Interior baffle between suction and discharge
- Large 2" NPT suction/return ports & 1.25" suction/return ports
- Magnetic drain plug
- Can be shipped U.P.S.

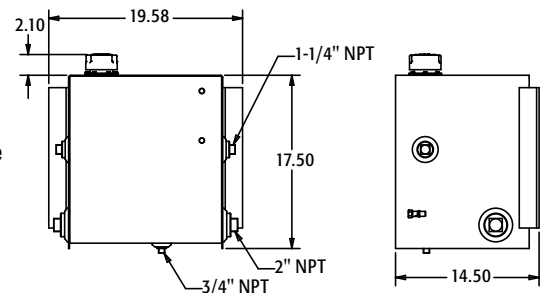

Part No.	Description	Usable Capacity	Wt. (lbs.)	Cat.
SMR15S	15 Gallon Reservoir, Steel	11.0 gal.	60.5	638 (N)

Reservoirs

15 Gallon Stainless Steel Reservoirs with Return Filter



SMR15SSF10

- 304 stainless steel construction
- Welded mounting angles
- 1/4 turn nylon chrome filler breather with strainer
- Oil level gauge with temperature indicator
- Interior baffle between suction and discharge
- Large 2" NPT suction/return ports & 1.25" suction/return ports
- Pre drilled for tank mounted filter, included with HFA91025 or HFA92525 (shipped separately)
- Magnetic drain plug
- Can be shipped U.P.S.

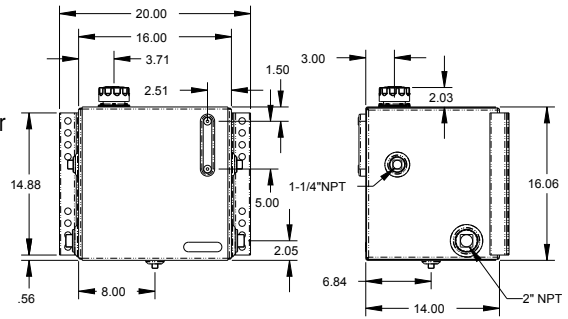

Part No.	Description	Usable Capacity	Wt. (lbs.)	Cat.
SMR15SSF10	15 Gallon Reservoir, Stainless Steel, with 10 Micron Filter	11.0 gal.	62.0	638 (N)
SMR15SSF25	15 Gallon Reservoir, Stainless Steel, with 25 Micron Filter	11.0 gal.	62.0	638 (N)

15 Gallon Stainless Steel Reservoir



- 304 stainless steel construction
- Welded mounting angles
- 1/4 turn nylon chrome filler breather with strainer
- Oil level gauge with temperature indicator
- Interior baffle between suction and discharge
- Large 2" NPT suction/return ports & 1.25" suction/return ports
- Magnetic drain plug
- Can be shipped U.P.S.

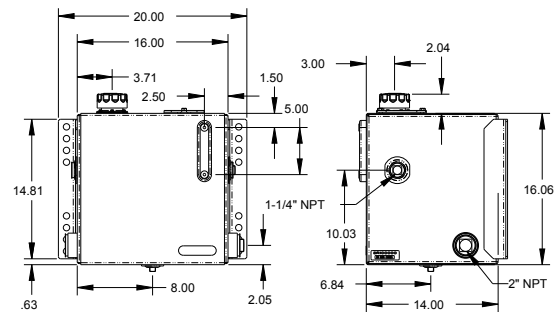

Part No.	Description	Usable Capacity	Wt. (lbs.)	Cat.
SMR15SS	15 Gallon Reservoir, Stainless Steel	11.0 gal.	60.0	638 (N)

7 Gallon Steel Reservoir



- 12 Gauge steel construction
- 3/4" breather cap
- 3/4" magnetic drain plug
- 1-1/4" suction ports
- 1" return ports
- Low profile design allows for use in small areas
- All sides of the reservoir are ported, allowing for multiple mounting positions

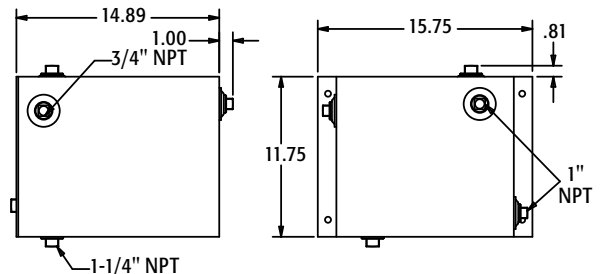

Part No.	Description	Usable Capacity	Wt. (lbs.)	Cat.
SMR7S	7 Gallon Reservoir, Steel	7.0 gal.	36	638 (N)

30 Gallon Stainless Steel Reservoir with Valve Enclosure



Shown with lid removed

- 10 gauge 304 stainless steel construction
- 3/4", 1", & 1-1/4" NPT return ports inside valve enclosure
- 1-1/4" NPT port on front
- 2" NPT suction port
- 3/4" NPT port on top, inside enclosure
- 50 GPM tank mounted return line filter, 1-1/4 port
- Water resistant valve enclosure
- Removable valve mounting and hose routing plate
- 2" suction strainer
- Chrome nylon rust free filler/breather

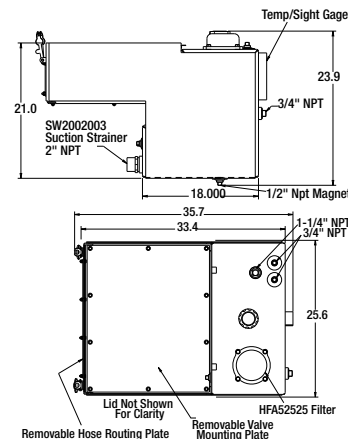

Part No.	Description	Usable Capacity	Wt. (lbs.)	Cat.
SMR30VESS	30 Gallon Stainless Steel Reservoir with Valve Enclosure	23.0 gal.	264.00	638 (N)

15 Gallon Stainless Steel Reservoir with Valve Enclosure



shown with lid removed

- 10 gauge 304 stainless steel construction
- 3/4", 1", & 1-1/4" NPT return ports on front
- 1-1/4" NPT port on front
- 2" NPT suction port
- 3/4" NPT port on top, inside enclosure
- 26 GPM tank mounted return line filter, 1-1/4 port
- Water resistant valve enclosure
- Removable valve mounting and hose routing plate
- 2" suction strainer
- Nylon rust free filler/breather unit

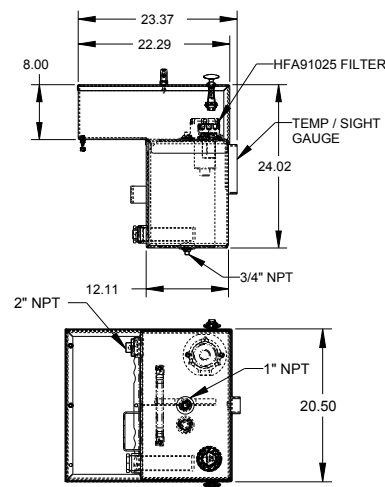

Part No.	Description	Usable Capacity	Wt. (lbs.)	Cat.
SMR15VESS	15 Gallon Stainless Steel Reservoir with Valve Enclosure	13.4 gal.	78.00	638 (N)

8 Gallon Steel Frame Mount Reservoir



SMR15SSF10

- HD 7/11 gauge steel construction
- Mounts behind cab, between frame rails
- Fully-baffled 8 gallon reservoir
- Includes hydraulic valve for dump bed operation
- Compact, low-profile design
- Valve must be plumbed to tank
- **Not a Williams style replacement unit**

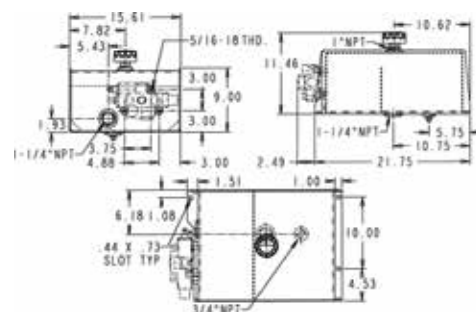

Part No.	Description	Usable Capacity	Wt. (lbs.)	Cat.
FMR8S3W	8 Gallon Steel Reservoir, Power Up / Gravity Down	6.0 gal.	73.58	638 (N)
FMR8S3WPB	8 Gallon Steel Reservoir, Power Up / Gravity Down with Power Beyond	6.0 gal.	74.50	638 (N)
FMR8S4W	8 Gallon Steel Reservoir, Power Up / Power Down	6.0 gal.	75.75	638 (N)
FMR8S4WPB	8 Gallon Steel Reservoir, Power Up / Power Down with Power Beyond	6.0 gal.	75.54	638 (N)
FMR8S	8 Gallon Frame Mount Steel Reservoir, Valve Not Included	6.0 gal.	60.50	638 (N)

Wetline Kits

50 and 70 Gallon Side Mount Reservoir/Direct Mount Pump Wetline Kit

Your choice of Aluminum, Steel or Poly



SMWLK50ADMCCW



SMWLK50DMCCW



SMWLK50PDMCW

Kit contains:

- Side mount reservoir
- Reservoir bracket kit with fasteners
- 46 GPM at 1800 RPM cast iron pump/valve combination
- 6' of internally reinforced 1-1/4" suction hose
- Two 1-1/4" barbed adapter fittings
- One 1-1/2" x 1-1/4" reducing bushing
- Two 1-1/4" S.S. hose clamps
- One 1" high pressure swivel adapter
- One 1" wing type high pressure quick detach coupler
- One 6' long 1" high pressure hose

Part No.	Description	Tank Material	Rotation	Wt. (lbs.)	Cat.
SMWLK50ADMCCW	50 Gallon Wetline Kit	Aluminum	Counterclockwise	191	648 (N)
SMWLK50DMCCW	50 Gallon Wetline Kit	Steel	Counterclockwise	243	648 (N)
SMWLK50PDMCW	50 Gallon Wetline Kit	Poly	Clockwise	165	648 (N)
SMWLK50PDMCCW	50 Gallon Wetline Kit	Poly	Counterclockwise	165	648 (N)
SMWLK70ADMCW	70 Gallon Wetline Kit	Aluminum	Clockwise	201	648 (N)
SMWLK70ADMCCW	70 Gallon Wetline Kit	Aluminum	Counterclockwise	201	648 (N)
SMWLK70DMCW	70 Gallon Wetline Kit	Steel	Clockwise	261	648 (N)
SMWLK70DMCCW	70 Gallon Wetline Kit	Steel	Counterclockwise	261	648 (N)

37 and 50 Gallon Wetline Kit for Live Floor



LFK3718



LFK5018

- Operates Live Floor Trailer
- **Kit includes:**
- 37 or 50 gallon steel reservoir
- Dowelled pump with built in relief
- Ball valve, wing couplers, hose, fittings, clamps and adapters
- Tank mounted filter 50 GPM
- This system is designed for optimum speed and longevity

Part No.	Description	Tank Material	Rotation	Wt. (lbs.)	Cat.
LFK3718	37 Gallon Reservoir, 18 GPM Pump	Steel	Counterclockwise	143.3	648 (N)
LFK3724	37 Gallon Reservoir, 24 GPM Pump	Steel	Counterclockwise	143.3	648 (N)
LFK5018	50 Gallon Reservoir, 18 GPM Pump	Steel	Counterclockwise	228	648 (N)
LFK5024	50 Gallon Reservoir, 24 GPM Pump	Steel	Counterclockwise	228	648 (N)

50 and 70 Gallon Upright Reservoir/Direct Mount Pump Wetline Kit

Your choice of Aluminum, Steel or Poly



UWLK70ADMCCW



UWLK50DMCW



UWLK50PDMCW

- **Kit contains:**
- Upright reservoir
- Frame bracket kit with fasteners
- Reservoir isolation package
- 46 GPM at 1800 RPM cast iron pump/valve combination with brackets
- 6' internally reinforced 1-1/4" suction hose
- Two 1-1/4" barbed adapter fittings
- Two 1-1/4" S.S. hose clamps
- One 1" high pressure swivel adapter
- One 1" wing type high pressure quick detach coupling
- One 6' long 1" high pressure hose

Part No.	Description	Material	Rotation	Wt. (lbs.)	Cat.
UWLK50ADMCCW	50 Gallon Wetline Kit	Aluminum	Clockwise	172	648 (N)
UWLK50ADMCCW	50 Gallon Wetline Kit	Aluminum	Counterclockwise	172	648 (N)
UWLK50DMCW	50 Gallon Wetline Kit	Steel	Clockwise	271	648 (N)
UWLK50DMCCW	50 Gallon Wetline Kit	Steel	Counterclockwise	271	648 (N)
UWLK50PDMCW	50 Gallon Wetline Kit	Poly	Clockwise	285	648 (N)
UWLK50PDMCCW	50 Gallon Wetline Kit	Poly	Counterclockwise	285	648 (N)
UWLK70DMCW	70 Gallon Wetline Kit	Steel	Clockwise	320	648 (N)
UWLK70DMCCW	70 Gallon Wetline Kit	Steel	Counterclockwise	320	648 (N)
UWLK70ADMCCW	70 Gallon Wetline Kit	Aluminum	Counterclockwise	187	648 (N)

50 and 70 Gallon Dual Pressure Direct Mount Pump Wetline Kit



DLFK50CCW



DLFK50CCWSM

- Designed to operate a live floor as well as a dump trailer
- **Kit contains:**
- Upright or side mount steel reservoir
- Frame bracket kit with fasteners
- Valve panel
- 42 GPM at 1800 RPM valve with main relief preset at 2800 PSI (walking floor)
- Port relief set at 2000 PSI (Hoist)
- Dowelled pump rated to 3000 PSI
- 100 GPM return line filter
- Sleek in cab pneumatic controls with console
- All hose, adapters, clamps, & fittings
- 2 ball valves, 3 wing type couplers

Part No.	Description	Mount Style	Material	Rotation	Wt. (lbs.)	Cat.
DLFK50CCW	50 Gallon Dual Pressure Kit, 18 GPM Pump	Upright	Steel	Counterclockwise	390	648 (N)
DLFK50CCW24	50 Gallon Dual Pressure Kit, 24 GPM Pump	Upright	Steel	Counterclockwise	390	648 (N)
DLFK50CCWSM	50 Gallon Dual Pressure Kit, 18 GPM Pump	Side	Steel	Counterclockwise	379	648 (N)
DLFK70CCW	70 Gallon Dual Pressure Kit, 18 GPM Pump	Upright	Steel	Counterclockwise	430	648 (N)

Welding Flanges

Stamped



FS012



FSSW025

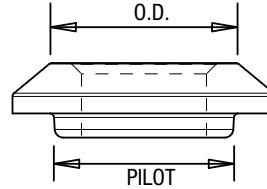

Part No.	SIZE/MATERIAL	O.D.	PILOT	THICKNESS	Wt. (lbs.)	Cat.
Aluminum						
FA025	1/4" Aluminum	1.770"	.600"	.134"	4	629 (N)
FA038	3/8" Aluminum	1.770"	.755"	.134"	4	629 (N)
FA050	1/2" Aluminum	1.780"	.930"	.134"	4	629 (N)
FA075	3/4" Aluminum	2.350"	1.135"	.134"	7	629 (N)
FA100	1" Aluminum	2.360"	1.385"	.134"	7	629 (N)
FA125	1-1/4" Aluminum	2.868"	1.740"	.134"	8	629 (N)
FA150	1-1/2" Aluminum	3.25"	1.75"	.55"	10	629 (N)
FA200	2" Aluminum	3.81"	2.22"	.81"	12	629 (N)
Steel						
FS012	1/8" Steel	1.680"	.480"	.134"	9	629 (N)
FS025	1/4" Steel	1.770"	.755"	.134"	9	629 (N)
FS038	3/8" Steel	1.770"	.755"	.134"	9	629 (N)
FS050	1/2" Steel	1.780"	.930"	.134"	9	629 (N)
FS075	3/4" Steel	2.350"	1.135"	.134"	15	629 (N)
FS100	1" Steel	2.360"	1.385"	.134"	15	629 (N)
FS125	1-1/4" Steel	2.868"	1.740"	.134"	18	629 (N)
FS150	1-1/2" Steel	3.658"	1.958"	.118"	30	629 (N)
FS200	2" Steel	3.705"	2.455"	.118"	30	629 (N)
Stainless Steel						
FSSW025	1/4" Stainless Steel	1.738"	.620"	.134"	8.0	629 (N)
FSSW038	3/8" Stainless Steel	1.738"	.755"	.134"	8.2	629 (N)
FSSW050	1/2" Stainless Steel	1.740"	.910"	.134"	8.7	629 (N)
FSSW075	1/4" Stainless Steel	2.355"	1.110"	.134"	9.4	629 (N)
FSSW100	1" Stainless Steel	2.317"	1.370"	.134"	10.0	629 (N)
FSSW125	1-1/4" Stainless Steel	2.847"	1.745"	.134"	10.6	629 (N)
FSSW150	1-1/2" Stainless Steel	3.240"	1.958"	.134"	11.3	629 (N)

Forged Steel



FDF012

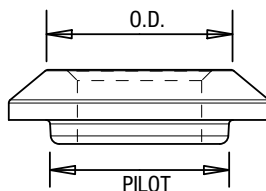

Part No.	SIZE/MATERIAL	O.D.	PILOT	THICKNESS	Wt. (lbs.)	Cat.
FDF012	1/8" Forged Steel	1.312"	1.312"	-	10	629 (N)
FDF025	1/4" Forged Steel	1.312"	1.312"	-	9	629 (N)
FDF038	3/8" Forged Steel	1.312"	1.937"	-	7	629 (N)
FDF050	1/2" Forged Steel	1.625"	1.125"	-	12	629 (N)
FDF075	3/4" Forged Steel	1.937"	1.375"	-	19	629 (N)
FDF100	1" Forged Steel	2.25"	1.687"	-	29	629 (N)
FDF125	1-1/4" Forged Steel	2.562"	2"	-	33	629 (N)
FDF150	1-1/2" Forged Steel	2.812"	2.25"	-	37	629 (N)
FDF200	2" Forged Steel	3.375"	2.625"	-	51	629 (N)
FDF250	2-1/2" Forged Steel	4.062"	3.156"	-	110	629 (N)
FDF300	3" Forged Steel	4.625"	3.656"	-	126	629 (N)
FDF400	4" Forged Steel	5.812"	4.719"	-	212	629 (N)

Chrome Filler-Strainer Breather Metal Cap Assembly



- Contains 1/4 turn chrome filler breather (40 micron) cap with chain
- "Hydraulic Fluid Only" stamped on cap
- 6 self tapping screws
- 1 30 mesh (500 micron) strainer basket
- 1 mounting flange with 2 gaskets

Part No.	Description	Wt. (lbs.)	Cat.
TFA005715	Filler-Strainer Breather Cap Assy.	.56	635 (N)
TFA005715L	Filler-Strainer Breather Cap Assy. with Locking Tab	.56	635 (N)
BC40	Filler-Strainer Breather Cap Assy. with Plastic Basket	.74	635 (N)
TC0015	Replacement Cap with Chain	.33	635 (N)
BRA64000	Cap Gasket	.004	635 (N)
BRA64500	Basket Gasket	.008	635 (N)

Polymer Filler-Strainer Breather Cap Assembly



- Rust-Free high impact nylon construction
- 1/4 Turn filler/breather (40 micron) cap with chain
- "Hydraulic Fluid Only" on cap
- 6 self-tapping screws
- 1 30 mesh (500 micron) strainer basket
- 1 Mounting flange with 2 - Rubber gaskets
- Temperature range: -22° F to +240° F

Part No.	Description	Wt. (lbs.)	Cat.
TFAN3C	Breather Cap Assembly, Chrome Cap	.56	635 (N)
TFAN3	Breather Cap Assembly	.56	635 (N)

Push-In Breather Caps



- Acts as ventilator to provide a free flow of clean, fresh air into hydraulic fluid, fuel, oil, chemical & coolant tanks or reservoirs
- Large oil resistant filter elements filter dirt & dust particles as small as 40 micron

Part No.	Description	Wt. (lbs.)	Cat.
BECO61A	Push-In Type Breather Cap for 1-1/2" O.D. Tube, Chrome	.24	635 (N)
BECO61AB	Push-In Type Breather Cap for 1-1/2" O.D. Tube, Black (Heavy Duty)	.24	635 (N)

Breather Cap



- Acts as ventilator to provide a free flow of clean, fresh air into hydraulic fluid, oil, chemical & coolant tanks or reservoirs
- Large oil resistant filter elements filter dirt & dust particles as small as 40 micron

Part No.	Description	Wt. (lbs.)	Cat.
HBF2	Breather Cap 1/8" NPT	.20	635 (N)
HBF4	Breather Cap 1/4" NPT	.15	635 (N)
HBF6	Breather Cap 3/8" NPT	.17	635 (N)
HBF8	Breather Cap 1/2" NPT	.29	635 (N)
HBF12	Breather Cap 3/4" NPT	.54	635 (N)
HBF12P	Breather Cap 3/4" NPT, Plastic	.04	635 (N)
HBF16	Breather Cap 1" NPT	.70	635 (N)

Filler Breather Weld Flange Adapter



- 12 gauge flange
- Welds to the top of reservoirs to adapt to most standard filler breather units
- Provides 1" rise

Part No.	Description	Wt. (lbs.)	Cat.
TAF001	Filler Breather Weld Flange Adaptor, Steel	.61	638 (N)
TAF001A	Filler Breather Weld Flange Adaptor, Aluminum	.22	638 (N)

Reservoir Cleanout Filter Flange Assembly



- Assembly provides access for reservoir cleaning and internal suction strainer
- Flange only provides mounting surface for tank mounted HFA5S series return filter

Part No.	Description	Wt. (lbs.)	Cat.
CPA56	Filter Flange Assembly	2.88	635 (N)
CP56	Cover Plate	1.49	635 (N)
3005534	Gasket	.12	635 (N)

Reservoir Accessories

Magnetic Drain Plug with Square Socket



- 1" NPT Port
- Square socket plug (PPM08 & PPM16)

Part No.	Description	Wt. (lbs.)	Cat.
PPM16	1" Magnetic Pipe Plug, Square Socket	.50	627 (N)

Magnetic Drain Plug with Square Head



- 3/4" NPT Port
- Square head plug (PPM12)

Part No.	Description	Wt. (lbs.)	Cat.
PPM08	1/2" Magnetic Pipe Plug, Square Socket	.12	627 (N)
PPM12	3/4" Magnetic Pipe Plug, Square Head	.19	627 (N)

Buzzer Light



- Warning light & buzzer operate simultaneously for 2-way warning
- For 12 VDC electrical systems
- 0.2 A max draw
- 70 DB at 3 ft

Part No.	Description	Wt. (lbs.)	Cat.
BL10	Buzzer Light	.16	639 (N)

Filter Element Monitoring Kit



- Dash mounted indicator light indicates when element is dirty
- Enables driver to monitor element condition under working conditions
- Pressure switch is preset at 25 PSI

Part No.	Description	Wt. (lbs.)	Cat.
PSK25	Filter Element Monitor, 25 PSI	1.00	639 (N)

Oil Level Gauge with Temperature Indicator



- Polycarbonate body
- 1/2"-13 NC threaded bolts
- 5" on center
- Nylon molded outer wrap to shield gauge from impact

Part No.	Description	Wt. (lbs.)	Cat.
LDR02A	Oil Level Gauge with Temperature Indicator, Glass	.65	630 (N)

Oil Level Gauge with Temperature Indicator



- Polycarbonate body/window
- 1/2"-13 NC threaded bolts
- 5" on center

Part No.	Description	Wt. (lbs.)	Cat.
LDR04	Oil Level Gauge with Temperature Sight Gauge	.65	630 (N)

Sight Level Gauge



- Zinc plated
- Rated at 125 PSI / 250°

Part No.	Description	Wt. (lbs.)	Cat.
HSG075	3/4" NPT Sight Level Gauge	0.10	630 (N)
HSG100	1" NPT Sight Level Gauge	0.20	630 (N)
HLLG1	5" Hydraulic Liquid Level Gauge, 1/2"-13 NC thd.	0.18	630 (N)

Pressure Switches



- Preset at 15 PSI (PS15)
- Preset at 25 PSI (PS25)
- Proof 350 PSI (Max pressure diaphragm will handle before failing)
- Normally open & (NC SPDT)
- 1/8" NPT

Part No.	Description	Wt. (lbs.)	Cat.
PS15	Pressure Switch, 15 PSI, 1/8" NPT	0.25	640 (N)
PS25	Pressure Switch, 25 PSI, 1/8" NPT	0.25	627 (N)

Pressure Switches

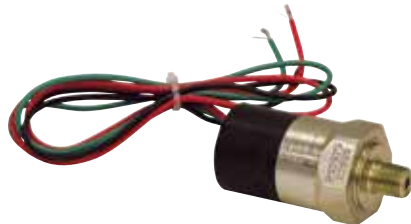

- **PS2575:**
 - Adjustable Range 25-75 PSI
 - Proof 1000 PSI (Max pressure diaphragm will handle before failing)
 - Open or Closed (SPDT)
 - 1/8" NPT
- **PS2501K:**
 - Adjustable Range 250-1,000 PSI
 - Proof 9,000 PSI (Max pressure diaphragm will handle before failing)
 - 1/4" NPT

Part No.	Description	Wt. (lbs.)	Cat.
PS2575	Pressure Switch, Adj. 25-75 PSI	0.25	624 (N)
PS2501K	Pressure Switch, Adj. 250-1,000 PSI	0.50	624 (N)

Oil Level Sensor Kit



- Provides operator with an in-cab monitoring light, indicating when oil is low
- Requires a 1" NPT port in reservoir top
- Indicator light presses into any 1/2" diameter hole
- Kit contains: 1 Electric Fluid Level Switch, 1 B272332 Light (Red), 1 E79855 Fuse, 2 E11 Insulate Female Disconnect, 4 E421005 FXF Connector, 1 E22D Decal - "Hydraulic Fluid Low"

Part No.	Description	Wt. (lbs.)	Cat.
E22	Oil Level Sensor Kit	0.61	630 (N)

Oil Level Sensor Kit with Slosh Shield



- Provides operator with an in-cab monitoring light, indicating when oil is low
- Requires a 1" NPT port in reservoir top
- Indicator light presses into any 1/2" diameter hole
- Kit contains: 1 Electric Fluid Level Switch, 1 B272332 Light (Red), 1 E79855 Fuse, 2 E11 Insulate Female Disconnect, 4 E421005 FXF Connector, 1 E22D Decal - "Hydraulic Fluid Low"

Part No.	Description	Wt. (lbs.)	Cat.
E32	Oil Level Sensor Kit with Slosh Shield	0.65	630 (N)

Gauges

Silicone Filled Pressure Gauge, Stem Mount



- 2-1/2" diameter stainless steel case & bezel
- Built in relief valve
- Dual scale; Accuracy $\pm 1.6\%$ full scale
- Deflection center 40% of scale, otherwise 2% FSD
- Standard stem is 1/4 NPT

Part No.	Description	Wt. (lbs.)	Cat.
HPGS100	Stem Mount 0-100 PSI	0.50	630 (N)
HPGS160	Stem Mount 0-160 PSI	0.50	630 (N)
HPGS200	Stem Mount 0-200 PSI	0.50	630 (N)
HPGS300	Stem Mount 0-300 PSI	0.50	630 (N)
HPGS500	Stem Mount 0-500 PSI	0.50	630 (N)
HPGS1	Stem Mount 0-1000 PSI	0.50	630 (N)
HPGS3	Stem Mount 0-3000 PSI	0.50	630 (N)
HPGS4	Stem Mount 0-4000 PSI	0.50	630 (N)
HPGS5	Stem Mount 0-5000 PSI	0.50	630 (N)
HPGS10	Stem Mount 0-10,000 PSI	0.50	630 (N)

Silicone Filled Pressure Gauge, Flange Mount



- 2-1/2" diameter stainless steel case & bezel
- Built in relief valve
- Dual scale; Accuracy $\pm 1.6\%$ full scale
- Deflection center 40% of scale, otherwise 2% FSD
- Standard stem is 1/4 NPT

Part No.	Description	Wt. (lbs.)	Cat.
HPGP3	Panel Flange Mount 0-3000 PSI	0.65	652 (Y)
HPGP5	Panel Flange Mount 0-5000 PSI	0.65	652 (Y)

Silicone Filled Pressure Gauge, Panel Clamp Mount



- 2-1/2" diameter stainless steel case & bezel
- Built in relief valve
- Dual scale; Accuracy $\pm 1.6\%$ full scale
- Deflection center 40% of scale, otherwise 2% FSD
- Standard stem is 1/4 NPT

Part No.	Description	Wt. (lbs.)	Cat.
HPGC100	Panel Clamp Mount 0-100 PSI	0.66	651 (Y)
HPGC160	Panel Clamp Mount 0-160 PSI	0.66	651 (Y)

Silicone Filled Pressure Gauge, Center Back Mount



- 2-1/2" diameter stainless steel case & bezel
- Built in relief valve
- Dual scale; Accuracy $\pm 1.6\%$ full scale
- Deflection center 40% of scale, otherwise 2% FSD
- Standard stem is 1/4 NPT

Part No.	Description	Wt. (lbs.)	Cat.
HPGCB160	Center Back Mount 0-160 PSI	0.55	630 (N)
HPGCB300	Center Back Mount 0-300 PSI	0.55	630 (N)

Return Line Diffuser



- This 8-7/8" long diffuser is highly effective in reducing aeration, foaming, turbulence and noise caused by return lines

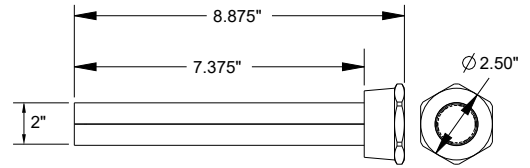

Part No.	Description	Wt. (lbs.)	Cat.
HD200125	2" MNPT x 1.25" FNPT Diffuser	0.92	635 (N)

Thru-wall Sump Strainer



- Cleanable 100 mesh stainless steel wire cloth
- Flow Rating: 5 GPM (19 L/min.) to 50 GPM (189 L/min.)
- 3 PSI bypass
- Nominal rating: 150 micron
- Cast iron bushing

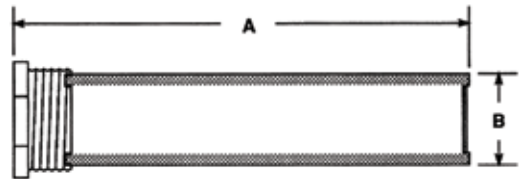

Part No.	Flow GPM	Flow L/Min	NPT Sizes Male Thread	NPT Size Female Outlet Port	Element Area	A	B	Wt. (lbs.)	Cat.
SW1000503	5	19	1"	1/2"	36 sq. in.	4.71"	1.00"	0.68	635 (N)
SW1250753	10	38	1-1/4"	3/4"	70 sq. in.	8.18"	1.38"	0.48	635 (N)
SW1501003	15	57	1-1/2"	1"	90 sq. in.	7.91"	1.56"	0.59	635 (N)
SW2001253	25	95	2"	1-1/4"	125 sq. in.	9.01"	2.00"	1.10	635 (N)
SW3002003	50	189	3"	2"	285 sq. in.	9.31"	3.00"	1.84	635 (N)

Thru-Wall Sump Strainer with Valve Threading



- Cleanable 100 mesh stainless steel wire cloth
- 2" NPTF Port
- Flow Rating: 49 GPM (5ft/sec)
- 3 PSI bypass
- Nominal rating: 150 micron

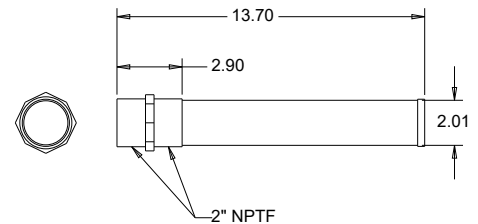

Part No.	Flow GPM	Flow L/Min	NPT Sizes Male Thread	NPT Size Outlet Port	Element Area	Wt. (lbs.)	Cat.
SW2002003	49	185	2"	2"	105.6 sq. in.	1.20	635 (N)

Single Element Sump Strainer



- Cleanable 100 mesh stainless steel wire cloth
- 1" to 2-1/2" NPTF port size
- Extra large filtering area with integral 3 PSI bypass valve
- Nominal rating: 150 micron

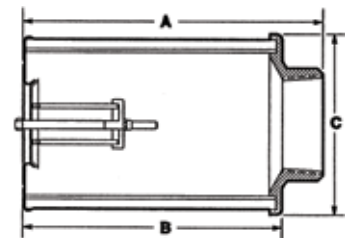

Part No.	Flow GPM	Flow L/Min	Port Sizes (NPTW)	A	B	C	Wt. (lbs.)	Cat.
SI1003	10	38	1"	5.34"	4.60"	2.62"	0.66	635 (N)
SI1253	20	76	1-1/4"	6.84"	6.10"	3.36"	0.70	635 (N)
SI1503	30	114	1-1/2"	8.03"	7.28"	3.37"	1.10	635 (N)
SI2003	50	189	2"	9.86"	9.10"	3.93"	1.20	635 (N)
SI2503	75	284	2-1/2"	10.14"	8.72"	5.12"	1.70	635 (N)

Buyers Products Clutch Units and PTOs

To place an order, please call our Hydraulics Department at 440-299-5430 or 844-974-8324 (select option 4). Buyers carries a wide range of clutch pump and PTO options, with thousands of potential configurations available to suit any application. Our experts will go over your needs and answer any questions you may have to ensure the units we build you are custom tailored to meet your specifications.

Clutch Pump Units provide a compact, efficient, and easy-to-install source of hydraulic power for most popular trucks and off-road vehicles. These pumps are engine-mounted, belt-driven units with a specially designed mounting bracket. Controlled by a simple in-cab on/off switch, the clutch pump only operates when needed and even works when the vehicle is moving.

Clutch Specifications:

- Electrical clutch - ON to engage; OFF to disengage
- Rated 90 ft lb nominal 120 ft lb after clutch plates have seated to full torque engagement
- All electrical materials are rated at Class A (105 degrees C)
- Zinc plated for corrosion resistance

Typical Applications:

- Snow removal equipment
- Salt and de-icer spreaders
- Grain augers and conveyors
- Fertilizer spreaders
- Portable lumber machinery
- Auxiliary circuits for farm and construction equipment
- Hydraulic tools
- Dump truck kits
- Tow trucks
- Whenever live hydraulics are required on a vehicle

Clutch Pump Features:

- Engine mounted, belt driven clutch
- Adaptable to virtually any pickup truck, van, tractor, dump truck or vehicle with a 15 HP and up engine
- PTO and PTO cables not required
- 12 volt unit



Buyers 1000 Series and 2000 Series PTO's

have been engineered to work with most existing transmissions in the market. They are durable with a wide range of input gears, shifters, speed ratios, and output shafts to meet all of the market applications.



1000 SERIES



2000 SERIES

To place an order, or if you have any questions, please call our Hydraulics Department at 440-299-5430 or 844-974-8324 (select option 4).

Remote Mount Hydraulic Dump Pump with Manual Valve



- Cast iron roller bearing dump pump
- Designed for 2 or 3 line installations
- All Remote Mount C1010 Series have 2-1/2" dia. gears
- To identify pump rotation, view pump with shaft facing you and belly of pump down
- Relief set at 2500 PSI
- **C1010 Series mounting bracket sold separately**

RPM	GPM Output
600	13
900	21
1200	33
1500	37.5
1800	46

Part No.	Description	Wt. (lbs.)	Cat.
C1010	Manual Valve Hydraulic Pump/Valve, Remote Mount, 1" Round Shaft 1/4" x 1-1/4" Keyway	74.0	620 (Y)
BPC1010BR	Pump Bracket for C1010 Series	5.0	621 (N)

Remote Mount Hydraulic Dump Pump with Air Control



- Cast iron roller bearing dump pump
- Designed for 2 or 3 line installations
- All Remote Mount C1010 Series have 2-1/2" dia. gears
- CW & CCW rotation input shaft
- Relief set at 2500 PSI
- Comes with air shift cylinder
- **C1010 Series mounting bracket sold separately**

RPM	GPM Output
600	13
900	21
1200	33
1500	37.5
1800	46

Part No.	Description	Wt. (lbs.)	Cat.
C1010AS	BPC1010 Hydraulic Pump, with AS301 Included, Remote Mount	76.0	130 (Y)
BPC1010BR	Pump Bracket for C1010 Series	5.0	621 (N)

Direct Mount Hydraulic Dump Pump with Manual Valve



- Cast iron roller bearing dump pump
- Designed for 2 or 3 line installations
- Direct mount pump includes a 4 bolt SAE B mounting flange and 7/8"-13 spline input shaft
- For direct pumps, rotation must be specified
- To identify pump rotation, view pump with shaft facing you and belly of pump down
- Relief valve set at 2500 PSI

RPM	GPM Output
600	13
900	21
1200	33
1500	37.5
1800	46

Part No.	Description	Wt. (lbs.)	Cat.
C1010DMCW	For Clockwise Rotation, Direct Mount	74.0	620 (Y)
C1010DMCCW	For Counterclockwise Rotation, Direct Mount	74.0	620 (Y)

Direct Mount Hydraulic Dump Pump with Air Control



- Cast iron roller bearing dump pump
- Designed for 2 or 3 line installations
- Direct mount pump includes a 4 bolt SAE B mounting flange and 7/8"-13 spline input shaft
- For direct pumps, rotation must be specified
- To identify pump rotation, view pump with shaft facing you and belly of pump down
- Relief valve set at 2500 PSI
- Comes with air shift cylinder

RPM	GPM Output
600	13
900	21
1200	33
1500	37.5
1800	46

Part No.	Description	Wt. (lbs.)	Cat.
C1010DMCWAS	C1010DMCW Hydraulic Pump, with AS301 Included, Direct Mount	76.0	130 (Y)
C1010DMCCWAS	C1010DMCCW Hydraulic Pump, with AS301 Included, Direct Mount	76.0	130 (Y)

Hydraulic Pumps

Remote Mount Small Hydraulic Pump with Air Control



- Ideal for small dump applications
- **Mounting:** CH101 (remote mount) 2 bolt mounting pad
- **Porting:** 1-1/4" inlet, 3/4" NPT cylinder port, 3/4" NPT return port
- Buyers comparable pumps for: Commercial*, Permco*, Tyrone*, Vickers®* & others
- CW & CCW rotation input shaft

Part No.	Gear Size	Mounting	C.I.R.	Flow @ 1000 RPM	Flow @ 1800 RPM	Max Pressure	Wt. (lbs.)	Cat.
CH101115	1-1/2"	Remote	2.96	11.7	21	2500	35	620 (Y)
CH101120	2"	Remote	3.94	16.1	29	2500	38	620 (Y)

Direct Mount Small Hydraulic Dump Pump with Manual Valve



- Ideal for small dump applications
- **Mounting:** CH102 (direct mount) SAE B 4 bolt flange, 7/8-13T shaft
- **Porting:** 1-1/4" inlet, 3/4" NPT cylinder port, 3/4" NPT return port
- To identify pump rotation, view pump with shaft facing you and belly of pump down
- Buyers comparable pumps for: Commercial*, Permco*, Tyrone*, Vickers®* & others

Part No.	Gear Size	Mounting	C.I.R.	Flow @ 1000 RPM	Flow @ 1800 RPM	Max Pressure	Wt. (lbs.)	Cat.
CH102115CCW	1-1/2"	Direct	2.96	11.7	21	2500	35	620 (Y)
CH102115CW	1-1/2"	Direct	2.96	11.7	21	2500	35	620 (Y)
CH102120CCW	2"	Direct	3.94	16.1	29	2500	38	620 (Y)
CH102120CW	2"	Direct	3.94	16.1	29	2500	38	620 (Y)

Air Shift Cylinder



- Converts manual pump operation to pneumatically controlled pump
- Complete with pump activator cylinder and mounting hardware
- Valve, tubing, fitting, and bracket kit are sold separately. Part No. K1010TAS
- Works on: Commercial* C101/C102, Buyers BPC1010, BPC1010DM, Muncie®* E Series, Permco* DMD25/DM640, Tyrone* T101/T102

Part No.	Description	Wt. (lbs.)	Cat.
AS301	Air Shift Cylinder	2.34	646 (N)
AS302	Air Shift Cylinder with Tubing & Fittings	2.65	646 (N)

Air Shift Cylinder



BASK16

BASK16P

- Converts manual pump operation to pneumatically controlled pump
- Complete with pump activator cylinder and mounting hardware
- Valve, tubing, fitting, and bracket kit are sold separately. Part No. K1010TAS
- (BASK16) Works on Commercial: * G101/G102, Buyers CH101/102
- (BASK16P) Works on: Permco* DM300/DM400

Part No.	Description	Wt. (lbs.)	Cat.
BASK16	Air Shift Cylinder	1.43	646 (N)
BASK16P	Air Shift Cylinder	1.38	646 (N)

Pump Support Bracket Kit



- Supports Buyers BPC1010-Series, C1010 -Series, Commercial* C101/ C102, Permco* DM640-Series
- Kit Includes: Transmission Plate, (2) Pump Plates, (2) Coupling Nuts, (2) 5/8" Bolts, (4) Flat Washers, (2) Lock Washers, Instructions
- 1/4" thick laser cut steel plates

Part No.	Description	Wt. (lbs.)	Cat.
PB10	Pump Support Bracket Kit	2.8	648 (N)

* Buyers Products is not authorized by nor affiliated with the manufacturer of Commercial, Permco, Tyrone, Muncie®, or Vickers® products.

H21 Series Hydraulic Gear Pump with Spine Shaft



- 2 & 4 Bolt SAE B Mount
- Birotational pump

Flow Chart/Gallon Per Min.					
Gear Width	1"	1-1/4"	1-1/2"	1-3/4"	2"
C.I.R.	2.0	2.5	3.0	3.5	4.0
RPM					
600	3.0	4.0	6.0	7.0	8.5
900	6.0	7.5	10.0	11.5	13.5
1000	6.8	8.3	11.7	13.3	15.8
1200	8.5	11.0	14.0	16.0	19.0
1500	11.0	14.0	17.5	20.5	24.0
1800	13.5	17.5	21.5	25.0	29.0
2100	16.0	21.0	25.5	29.5	34.5

Part No.	Mounting	Outboard Bearing	Shaft	Flow @ 1000 RPM	Max. Pressure	NPT Ports Side	NPT Ports Rear	Gear Width	Wt. (lbs.)	Cat.
H2136101	2/4 Bolt	N	7/8-13 Spline	6.8	3000	1"	1"	1	29.0	620 (Y)
H2136121	2/4 Bolt	N	7/8-13 Spline	8.7	3000	1"	1"	1-1/4	31.7	620 (Y)
H2136151	2/4 Bolt	N	7/8-13 Spline	11.3	3000	1"	1"	1-1/2	31.7	620 (Y)
H2136171	2/4 Bolt	N	7/8-13 Spline	13.0	2500	1-1/4"	1"	1-3/4	37.0	620 (Y)
H2136201	2/4 Bolt	N	7/8-13 Spline	15.3	2500	1-1/4"	1"	2	35.0	620 (Y)
H504	Pump Mounting Bracket for H21 Series								7.0	631 (N)

H21 Series Hydraulic Gear Pump with Keyed Shaft



- 2 & 4 Bolt SAE B Mount
- Birotational pump

Flow Chart/Gallon Per Min.					
Gear Width	1"	1-1/4"	1-1/2"	1-3/4"	2"
C.I.R.	2.0	2.5	3.0	3.5	4.0
RPM					
600	3.0	4.0	6.0	7.0	8.5
900	6.0	7.5	10.0	11.5	13.5
1000	6.8	8.3	11.7	13.3	15.8
1200	8.5	11.0	14.0	16.0	19.0
1500	11.0	14.0	17.5	20.5	24.0
1800	13.5	17.5	21.5	25.0	29.0
2100	16.0	21.0	25.5	29.5	34.5

Part No.	Mounting	Outboard Bearing	Shaft	Flow @ 1000 RPM	Max. Pressure	NPT Ports Side	NPT Ports Rear	Gear Width	Wt. (lbs.)	Cat.
H2136153	2/4 Bolt	Y	1" Keyed 1/4 KW	11.3	3000	1"	1"	1-1/2	16.47	620 (Y)
H2136173	2/4 Bolt	Y	1" Keyed 1/4 KW	13.0	2500	1-1/4"	1"	1-3/4	16.47	620 (Y)
H2136203	2/4 Bolt	Y	1" Keyed 1/4 KW	15.3	2500	1-1/4"	1"	2	39.0	620 (Y)
H2136123	2/4 Bolt	Y	1" Keyed 1/4 KW	8.7	3000	1"	1"	1-1/4	16.47	620 (Y)
H2136103	2/4 Bolt	Y	1" Keyed 1/4 KW	6.8	3000	1"	1"	1	16.47	620 (Y)
H504	Pump Mounting Bracket for H21 Series								7.0	631 (N)

H50 Series Hydraulic Gear Pump with Spine Shaft



- 2 & 4 Bolt SAE B Mount
- Birotational pump

Flow Chart/Gallon Per Min.				
Gear Width	1-3/4"	2"	2-1/4"	2-1/2"
C.I.R.	3.86	5.15	5.58	6.0
RPM				
600	10.0	11.0	12.0	13.0
900	15.0	17.5	19.0	21.0
1000	18.0	20.0	21.1	27.8
1200	21.0	24.0	26.5	29.0
1500	27.0	30.5	33.5	37.5
1800	32.5	37.0	41.0	46.0
2100	38.5	43.5	48.0	54.0

Part No.	Mounting	Outboard Bearing	Shaft	Flow @ 1000 RPM	Max. Pressure	NPT Ports Side	NPT Ports Rear	Gear Width	Wt. (lbs.)	Cat.
H5036171	2/4 Bolt	N	7/8-13 Spline	18	2500	1-1/4"	1-1/4"	1-3/4	45.0	620 (Y)
H5036201	2/4 Bolt	N	7/8-13 Spline	20	2500	1-1/4"	1-1/4"	2	44.0	620 (Y)
H5036221	2/4 Bolt	N	7/8-13 Spline	21.5	2500	1-1/2"	1-1/4"	2-1/4	51.28	620 (Y)
H2136171	2/4 Bolt	N	7/8-13 Spline	13.0	2500	1-1/4"	1"	1-3/4	37.0	620 (Y)
H5036251	2/4 Bolt	N	7/8-13 Spline	27.8	2500	1-1/2"	1-1/4"	2-1/2	50.0	620 (Y)
H504	Pump Mounting Bracket for H50 Series								7.0	631 (N)

Hydraulic Pumps

H50 Series Hydraulic Gear Pump with Keyed Shaft



- 2 & 4 Bolt SAE B Mount
- Birotational pump

Flow Chart/Gallon Per Min.				
Gear Width	1-3/4"	2"	2-1/4"	2-1/2"
C.I.R.	3.86	5.15	5.58	6.0
RPM				
600	10.0	11.0	12.0	13.0
900	15.0	17.5	19.0	21.0
1000	18.0	20.0	21.1	27.8
1200	21.0	24.0	26.5	29.0
1500	27.0	30.5	33.5	37.5
1800	32.5	37.0	41.0	46.0
2100	38.5	43.5	48.0	54.0

Part No.	Mounting	Outboard Bearing	Shaft	Flow @ 1000 RPM	Max. Pressure	NPT Ports Side	NPT Ports Rear	Gear Width	Wt. (lbs.)	Cat.
H5036203	2/4 Bolt	Y	1" Keyed 1/4 KW	20	2500	1-1/4"	1-1/4"	2	44.0	620 (Y)
H5036253	2/4 Bolt	Y	1" Keyed 1/4 KW	27.8	2500	1-1/2"	1-1/4"	2-1/2	50.0	620 (Y)
H504	Pump Mounting Bracket for H50 Series								7.0	631 (N)

Live Floor Hydraulic Pump



- 4 Bolt SAE B Mount
- Counter clockwise rotation
- No integral relief

Part No.	Mounting	Outboard Bearing	Shaft	Flow @ 1000 RPM	Max. Pressure	NPT Ports Suction/Pressure	NPT Ports Rear	Gear Width	Wt. (lbs.)	Cat.
H5134171	4 Bolt	Y	7/8-13 Spline	18	3000	1-1/4"	-	1-3/4	44.0	620 (Y)
H5134251	4 Bolt	Y	7/8-13 Spline	24.2	3000	1-1/2"	-	2-1/2	49.6	620 (Y)
H504	Pump Mounting Bracket for H50 Series								7.0	631 (N)

Live Floor Hydraulic Pump with Relief Port



- 4 Bolt SAE B Mount
- Counter clockwise rotation
- 1.00" relief port on rear cover

Part No.	Mounting	Outboard Bearing	Shaft	Flow @ 1000 RPM	Max. Pressure	NPT Ports Suction/Pressure	NPT Ports Rear	Gear Width	Wt. (lbs.)	Cat.
H6134171	4 Bolt	Y	7/8-13 Spline	18	3000	1-1/4"	1"	1-3/4	51.0	620 (Y)
H6134251	4 Bolt	Y	7/8-13 Spline	24.2	3000	1-1/2"	1"	2-1/2	49.6	620 (Y)
H504	Pump Mounting Bracket for H50 Series								7.0	631 (N)

Dual Shaft Hydraulic Pump



- Max. operating pressure 2500 PSI continuous duty
- 1800 Max. RPM
- Birotational pump
- Excellent for refuse applications

Gear Width	2"	2-1/2"
C.I.R.	5.15	6.43
RPM		
900	17.5	21.0
1000	22.3	27.8
1200	24.0	29.0
1500	30.5	37.5
1800	37.0	46.0

Part No.	Description	Shaft	Pressure Port	Suction Port	Wt. (lbs.)	Cat.
HDS36205	2" Gear	1.125"	1-1/16" Str. Thread	1-1/2" NPT	47.00	620 (Y)
HDS36255	2-1/2" Gear	1.125"	1-1/16" Str. Thread	1-1/2" NPT	49.75	620 (Y)

Hydraulic Motor



2 Bolt Mount Shown

Buyers Products Series motors are economical, efficient, compact, and powerful. Designed for medium duty applications, these motors have the industry proven spool valve design combined with state-of-the-art gerotors. In addition, a wide variety of mounting flanges with a 1" diameter straight shaft, 1/4" woodruff keyway, and 1/2" NPT port provides design flexibility. Direction of shaft rotation and shaft speed can be controlled easily and smoothly throughout the speed range of the motor, and equipment can be driven direct, eliminating costly mechanical components. **Other motors are available. Contact our Hydraulics Department at 440-299-5430 or 844-974-8324 (option 4) with your requirements.**

- 2P = 2 Bolt mount/NPT threads
- 4P = 4 Bolt mount/NPT threads

BUYERS	DISPL.	CHAR-LYNN ^{®1}	DISPL.	TRW ROSS ¹	DISPL.	PRINCE ¹	DISPL.	ORBMARK ^{®1}	DISPL.	WHITE ^{®1}	DISPL.	Wt. (lbs.)	Cat.
CM002P	2.8	101-1025	2.8	MG-03-12-10	3.0	ADM502RP	3.00	HD104W2FSWP	3.0	RS-03-0301	3.0	8.1	621 (N)
CM004P	2.8	101-1001	2.8	MG-03-13-10	3.0	ADM504RP	3.00	HD104W4FSWP	3.0	RS-03-0101	3.0	8.0	621 (N)
CM012P	4.5	101-1026	4.5	MG-05-12-10	5.0	ADM752RP	4.67	HD106W2FSWP	4.5	RS-04-0301	4.5	8.9	621 (N)
CM014P	4.5	101-1002	4.5	MG-05-13-10	5.0	ADM754RP	4.67	HD106W4FSWP	4.5	RS-05-0101	5.45	8.9	621 (N)
CM032P	7.3	101-1706	7.3	MG-06-12-10	-	ADM1002RP	6.07	HD108W2FSWP	6.2	RS-06-0301	6.4	9.9	621 (N)
CM034P	7.3	101-1755	7.3	MG-06-13-10	6.0	ADM1004RP	6.07	HD108W4FSWP	6.2	RS-06-0101	6.4	9.9	621 (N)
CM042P	9.7	101-1028	9.7	-	-	ADM1502RP	9.34	HD114W2FSWP	10.3	RS-10-0301	10.0	10.4	621 (N)
CM044P	9.7	101-1004	9.7	-	-	ADM1504RP	9.34	HD114W4FSWP	10.3	RS-10-0101	10.0	10.4	621 (N)
CM052P	11.3	101-1029	11.3	MG-12-12-10	12.0	ADM2002RP	12.15	HD114W2FSWP	10.3	RS-10-0301	10.0	10.9	621 (N)
CM054P	11.3	101-1005	11.3	MG-12-13-10	12.0	ADM2004RP	12.15	HD114W4FSWP	10.3	RS-10-0101	10.0	10.9	621 (N)
CM062P	14.1	101-1030	14.1	MG-14-12-10	12.0	ADM2502RP	15.25	HD120W2FSWP	14.9	RS-14-0301	14.6	11.56	621 (N)
CM072P	17.9	101-1031	17.9	MG-18-12-10	-	ADM3002RP	17.90	HD124W2FSWP	17.9	RS-18-0301	18.0	12.56	621 (N)
CM074P	17.9	101-1007	17.9	MG-18-13-10	18.0	ADM3004RP	17.90	HD124W4FSWP	17.9	RS-18-0301	18.0	12.56	621 (N)
CM082P	22.6	101-1032	22.6	MG-24-12-10	-	ADM4002RP	24.40	HD132W2FSWP	23.8	RS-24-0301	24.0	14.87	621 (N)
CM084P	22.6	101-1008	22.6	MG-24-13-10	24.0	ADM4004RP	24.40	HD132W4FSWP	23.8	RS-24-0101	24.0	14.87	621 (N)
CM092P	24.9	-	-	-	-	-	-	-	-	-	-	21.2	621 (N)
CM004PH	2.8	101-1313	-	-	-	-	-	-	-	-	-	12.75	621 (N)

	CM002P CM004P	CM012P CM014P	CM032P CM034P	CM042P CM044P	CM052P CM054P	CM062P CM064P	CM072P CM074P	CM082P CM084P
Displ. cm ³ /r [in ³ /r]	46 [2.8]	74 [4.5]	97 [5.9]	159 [9.7]	185 [11.3]	231 [14.1]	293 [17.9]	370 [22.6]
Max Speed (RPM) @ Continuous Flow	969	760	585	353	304	243	192	152
FLOW LPM [GPM]	Continuous	45 [12]	57 [15]	57 [15]	57 [15]	57 [15]	57 [15]	57 [15]
	Intermittent	53 [14]	68 [18]	68 [18]	76 [20]	76 [20]	76 [20]	76 [20]
Torque LPM [lb-in]	Continuous	73 [650]	118 [1044]	155 [1368]	233 [2059]	265 [2343]	302 [2669]	351 [3110]
	Intermittent**	99 [876]	158 [1401]	207 [1829]	319 [2824]	356 [3151]	415 [3671]	466 [4121]
Min. Starting Torque Nm [lb-in]	@ Cont. Pressure	59 [520]	95 [840]	124 [1100]	186 [1650]	211 [1870]	238 [2110]	282 [2500]
	@ Int. Pressure	81 [720]	130 [1150]	171 [1510]	262 [2320]	293 [2590]	339 [3000]	388 [3430]
Pressure Δ Bar [Δ PSI]	Continuous*	124 [1800]	124 [1800]	124 [1800]	114 [1650]	110 [1600]	100 [1450]	93 [1350]
	Intermittent*(**)	165 [2400]	165 [2400]	165 [2400]	155 [2250]	148 [2150]	138 [2000]	124 [1800]

Maximum Case Pressure, without Case Drain is 103 Bar [1500 PSI]

* Maximum intermittent pressure at motor inlet port of 172 Bar [2500 PSI] without regard to A Bar [A PSI] and/or back pressure ratings or combination thereof.

** A simultaneous maximum torque and maximum speed NOT recommended.

6B Splined or Tapered shafts are recommended whenever operating above 282 Nm [2500 lb-in] of torque, especially for those applications subject to frequent reversals.

Δ Bar [Δ PSI] – True pressure difference between inlet port and outlet port.

Continuous Rating – Motor may be run continuously at these ratings.

Intermittent Operation – 10% of every minute.

Recommended Fluids – Premium quality, anti-wear type hydraulic oil. Minimum oil viscosity (at operating temperature) should be the highest of the following:

$$100 \text{ SUS or } \frac{300 \times \text{Bar}}{\text{RPM}} = \text{SUS} \quad \left[\frac{20 \times \text{PSI}}{\text{RPM}} = \text{SUS} \right]$$

Recommended Maximum System Operating Temperature is 82° C [180° F]

Recommended Filtration – per ISO Cleanliness Code, level 18/13

To assure best motor life, run motor for approximately one hour at 30% of rated pressure before application to full load. Be sure motor is filled with fluid prior to any load applications.

¹Buyers Products is not authorized by nor affiliated with the manufacturer of Char-Lynn®, TRW Ross, Prince Hydraulics, Orbmark, or White Drive Products® products.

Hydraulic Motors

Char-Lynn Hydraulic Motor



4 Bolt Mount Shown

Char-Lynn® H Series motors are economical, efficient, compact, and powerful. Designed for medium duty applications, these motors have the industry proven spool valve design combined with state-of-the-art gerotors. In addition, a wide variety of mounting flanges with a 1" diameter straight shaft, 1/4" woodruff keyway, and 1/2" NPT port provides design flexibility. Direction of shaft rotation and shaft speed can be controlled easily and smoothly throughout the speed range of the motor, and equipment can be driven direct, eliminating costly mechanical components. **Other motors are available. Contact our Hydraulics Department at 440-299-5430 or 844-974-8324 (option 4) with your requirements.**

- 2P = 2 Bolt mount/NPT threads
- 4P = 4 Bolt mount/NPT threads

BUYERS	DISPL.	CHAR-LYNN ^{®1}	DISPL.	TRW ROSS ¹	DISPL.	PRINCE ¹	DISPL.	ORBMARK ^{®1}	DISPL.	WHITE ^{®1}	DISPL.	Wt. (lbs.)	Cat.
HM002P	2.8	101-1025	2.8	MG-03-12-10	3.0	ADM502RP	3.00	HD104W2FSWP	3.0	RS-03-0301	3.0	8.1	621 (N)
HM004P	2.8	101-1001	2.8	MG-03-13-10	3.0	ADM504RP	3.00	HD104W4FSWP	3.0	RS-03-0101	3.0	8.0	621 (N)
HM006P	2.8	101-1319	-	-	-	-	-	-	-	-	-	21.2	621 (N)
HM014P	4.5	101-1002	4.5	MG-05-13-10	5.0	ADM754RP	4.67	HD106W4FSWP	4.5	RS-05-0101	5.45	8.9	621 (N)
HM032P	7.3	101-1706	7.3	MG-06-12-10	-	ADM1002RP	6.07	HD108W2FSWP	6.2	RS-06-0301	6.4	9.9	621 (N)
HM034P	7.3	101-1755	7.3	MG-06-13-10	6.0	ADM1004RP	6.07	HD108W4FSWP	6.2	RS-06-0101	6.4	9.9	621 (N)
HM042P	9.7	101-1028	9.7	-	-	ADM1502RP	9.34	HD114W2FSWP	10.3	RS-10-0301	10.0	10.4	621 (N)
HM044P	9.7	101-1004	9.7	-	-	ADM1504RP	9.34	HD114W4FSWP	10.3	RS-10-0101	10.0	10.4	621 (N)
HM052P	11.3	101-1029	11.3	MG-12-12-10	12.0	ADM2002RP	12.15	HD114W2FSWP	10.3	RS-10-0301	10.0	10.9	621 (N)
HM054P	11.3	101-1005	11.3	MG-12-13-10	12.0	ADM2004RP	12.15	HD114W4FSWP	10.3	RS-10-0101	10.0	10.9	621 (N)
HM072P	17.9	101-1031	17.9	MG-18-12-10	-	ADM3002RP	17.90	HD124W2FSWP	17.9	RS-18-0301	18.0	12.56	621 (N)
HM074P	17.9	101-1007	17.9	MG-18-13-10	18.0	ADM3004RP	17.90	HD124W4FSWP	17.9	RS-18-0301	18.0	12.56	621 (N)
HM082P	22.6	101-1032	22.6	MG-24-12-10	-	ADM4002RP	24.40	HD132W2FSWP	23.8	RS-24-0301	24.0	14.87	621 (N)
HM084P	22.6	101-1008	22.6	MG-24-13-10	24.0	ADM4004RP	24.40	HD132W4FSWP	23.8	RS-24-0101	24.0	14.87	621 (N)

		HM002P HM004P	HM012P HM014P	HM032P HM034P	HM042P HM044P	HM052P HM054P	HM062P HM064P	HM072P HM074P	HM082P HM084P
Displ. cm ³ /r [in ³ /r]		46 [2.8]	74 [4.5]	97 [5.9]	159 [9.7]	185 [11.3]	231 [14.1]	293 [17.9]	370 [22.6]
Max Speed (RPM) @ Continuous Flow		969	760	585	353	304	243	192	152
FLOW LPM [GPM]	Continuous	45 [12]	57 [15]	57 [15]	57 [15]	57 [15]	57 [15]	57 [15]	57 [15]
	Intermittent	53 [14]	68 [18]	68 [18]	76 [20]	76 [20]	76 [20]	76 [20]	76 [20]
Torque LPM [lb-in]	Continuous	73 [650]	118 [1044]	155 [1368]	233 [2059]	265 [2343]	302 [2669]	351 [3110]	407 [3604]
	Intermittent**	99 [876]	158 [1401]	207 [1829]	319 [2824]	356 [3151]	415 [3671]	466 [4121]	484 [4283]
Min. Starting Torque Nm [lb-in]	@ Cont. Pressure	59 [520]	95 [840]	124 [1100]	186 [1650]	211 [1870]	238 [2110]	282 [2500]	330 [2920]
	@ Int. Pressure	81 [720]	130 [1150]	171 [1510]	262 [2320]	293 [2590]	339 [3000]	388 [3430]	408 [3610]
Pressure Δ Bar [Δ PSI]	Continuous*	124 [1800]	124 [1800]	124 [1800]	114 [1650]	110 [1600]	100 [1450]	93 [1350]	86 [1250]
	Intermittent**(**)	165 [2400]	165 [2400]	165 [2400]	155 [2250]	148 [2150]	138 [2000]	124 [1800]	103 [1500]

Maximum Case Pressure, without Case Drain is 103 Bar [1500 PSI]

* Maximum intermittent pressure at motor inlet port of 172 Bar [2500 PSI] without regard to A Bar [A PSI] and/or back pressure ratings or combination thereof.

** A simultaneous maximum torque and maximum speed NOT recommended.

6B Splined or Tapered shafts are recommended whenever operating above 282 Nm [2500 lb-in] of torque, especially for those applications subject to frequent reversals.

Δ Bar [Δ PSI] – True pressure difference between inlet port and outlet port.

Continuous Rating – Motor may be run continuously at these ratings.

Intermittent Operation – 10% of every minute.

Recommended Fluids – Premium quality, anti-wear type hydraulic oil. Minimum oil viscosity (at operating temperature) should be the highest of the following:

$$100 \text{ SUS or } \frac{300 \times \text{Bar}}{\text{RPM}} = \text{SUS} \left[\frac{20 \times \text{PSI}}{\text{RPM}} = \text{SUS} \right]$$

Recommended Maximum System Operating Temperature is 82° C [180° F]

Recommended Filtration – per ISO Cleanliness Code, level 18/13

To assure best motor life, run motor for approximately one hour at 30% of rated pressure before application to full load. Be sure motor is filled with fluid prior to any load applications.

¹Buyers Products is not authorized by nor affiliated with the manufacturer of Char-Lynn®, TRW Ross, Prince Hydraulics, Orbmark, or White Drive Products® products.

3-Way Valve D.C. Power Unit - Electric Controls



- Pump/motor/steel reservoir/control box with 6' cord
- Suction filter
- Large dump valve 8 GPM
- 3-way function, power up - gravity down
- External flow control on down side

Part No.	Reservoir Dimensions	Usable Gallons	NPTF Outlet Port	Mounting	Wt. (lbs.)	Cat.
PU303LRS	5-1/2" x 6-1/2" x 19"	3 (715 in ³)	.375"	Horizontal	48	636 (N)
HBF12P	3/4" Breather Cap				0.04	636 (N)
M3100	Replacement Motor - Light Duty, Replaces 08111 Motor				16.50	600 (N)
17757	3-Post Solenoid 12V Start				0.91	636 (N)

3-Way D.C. Power Unit- Electric Controls



- Pump/motor/reservoir/control station
- Externally adjustable system relief valve and check valve
- Solenoid actuated, normally closed release valve is mounted externally
- Double filtration: suction filter and valve body
- 3-way function, power up - gravity down

Part No.	Reservoir Dimensions	Reservoir Material	Usable Gallons	NPTF Outlet Port	Mounting	Wt. (lbs.)	Cat.
PU319	5-1/2" x 6-1/2" x 10"	Poly	.86 (199 in ³)	.375"	Horizontal	33	636 (N)
PU319LR	5-1/2" x 6-1/2" x 19"	Poly	1.87 (432 in ³)	.375"	Horizontal	42	636 (N)
PU319LRS	5-1/2" x 6-1/2" x 19"	Steel	1.87 (432 in ³)	.375"	Horizontal	42	636 (N)
1306510	Solenoid, Fits 304LR, 319LR, 642LR					0.91	900 (N)
HBF12P	3/4" Breather Cap					0.04	636 (N)
M3100	Replacement Motor - Replaces 08111 Motor					16.50	600 (N)
B7993	Replacement Control Box Only 4-Wire					-	636(N)
17006	Replacement Controller and Cord Assembly					1.5	636(N)
17757	Solenoid fits 304LR, 319LR, 642, 3593					1.5	636(N)

4-Way D.C. Power Unit- Electric Controls



- Pump/motor/reservoir/factory wired control station and cable
- Externally adjustable system relief valve
- Check valve
- Cartridge valves are located outside the reservoir on PU642 & PU642LR. Inside on PU642S & PU642LRS
- 4-way function, power up - power down
- C-1 port is positively checked (2500 PSI), raise; C-2 port 800 PSI, lower
- Triple filtration: suction, high pressure return and valve

Part No.	Reservoir Dimensions	Reservoir Material	Usable Gallons	NPTF Outlet Port	Mounting	Wt. (lbs.)	Cat.
PU642	5-1/2" x 6-1/2" x 10"	Poly	.86 (199 in ³)	.250"	Horizontal	39	636 (N)
PU642LR	5-1/2" x 6-1/2" x 19"	Poly	1.87 (432 in ³)	.250"	Horizontal	38	636 (N)
PU642LRS	5-1/2" x 6-1/2" x 19"	Steel	1.87 (432 in ³)	.250"	Horizontal	38	636 (N)
HBF12P	3/4" Breather Cap					0.04	636 (N)
M3100	Replacement Motor - Replaces Standard 08111 Motor					16.50	600 (N)
B7995	Replacement Control Box Only (4-Wire)					-	636(N)
17008	Replacement Controller and Cord Assembly					1.5	636(N)

4-Way/3-Way D.C. Power Unit- Electric Controls



- Pump/motor/reservoir/factory wired control station and cable
- Externally adjustable system relief valve
- Check valve
- Cartridge valves are located outside the reservoir on manifold block
- 4-way/3-way function, power up - gravity down
- C-1 & C2 plow angle 1200 PSI crossover relief, C-3 2000 PSI
- Triple filtration: suction, high pressure return and valve
- Plow lift and plow angle function supported

Part No.	Description	Reservoir Size	NPTF Outlet Ports	Mounting	Wt. (lbs.)	Cat.
PU3593	Electric 4-Way/3-Way Power Unit	1.36 Quart	.250"	Horizontal	34	636 (N)
PU3593LR	Electric 4-Way/3-Way Power Unit	.83 Gallon	.250"	Horizontal	42	636 (N)
PU3593LRV	Electric 4-Way/3-Way Power Unit	.872 Gallon	.250"	Vertical	42	636 (N)
HBF12P	3/4" Breather Cap				0.04	636 (N)
M3100	Replacement Motor - Light Duty, Replaces Standard 08111 Motor				16.50	600 (N)

DC Hydraulic Power Units

3-Way Valve D.C. Power Unit- Manual Controls



- Pump/motor/reservoir
- Externally adjustable system relief valve
- Manually operated 3-way valve with cylinder port checked
- Power Up - Gravity Down
- Electrical contact for synchronizing valve and motor
- .250" NPTF outlet
- Rod and ball handle
- Suction filter
- Horizontal mounting

Part No.	Description	Wt. (lbs.)	Cat.
PU5003	4-1/2" x 8" Poly Reservoir 1.36 Quart (79 in ³)	32	636 (N)
HBF12P	3/4" Breather Cap	0.04	636 (N)
M3100	Replacement Motor - Replaces Standard 08111 Motor	16.50	600 (N)

3-Way Metered Release Valve D.C. Power Unit - Manual Controls



- Pump/motor/reservoir
- Externally adjustable system relief valve
- Check valve and normally closed manually operated release valve with built-in metering for "fine control" of lowering speed
- Power Up - Gravity Down
- Heavy duty motor start switch
- .250" & .375" NPTF outlet ports
- Suction filter
- Rod and ball handle
- Horizontal mounting

Part No.	Description	Wt. (lbs.)	Cat.
PU311	5-1/2" x 6-1/2" x 10" Poly Reservoir Dimensions Only - .86 Gallon Usable (199 in ³)	32	636 (N)
PU311LR	5-1/2" x 6-1/2" x 19" Poly Reservoir - 1.87 Gallon Usable (432 in ³)	35	636 (N)
B63322	Solenoid, Canister Type Fits 304LR 319, 642 Series	0.48	636 (N)
HBF12P	3/4" Breather Cap	0.04	636 (N)
M3100	Replacement Motor - Replaces Standard 08111 Motor	16.50	600 (N)

3-Way/4-Way D.C. Power Unit- Manual Controls



- Pump/motor/reservoir
- Externally adjustable system relief valve
- 3-way/4-way valve, banked
- 4-way valve is tandem center rotary shear type with .250" NPTF outlets
- 3-way valve has checked cylinder port and .250" NPTF outlet
- Valve assembly is fitted with electrical contacts for synchronizing valve with motor
- Rod and ball handles
- Suction filter
- Horizontal mounting
- Plow lift, plow angle functions supported

Part No.	Description	Wt. (lbs.)	Cat.
PU5007	4-1/2" x 10" Poly Reservoir Dimensions Only 1.8 Quart (106 in ³)	35	636 (N)
HBF12P	3/4" Breather Cap	0.04	636 (N)
M3100	Replacement Motor - Light Duty, Replaces Standard 08111 Motor	16.50	600 (N)

4-Way Valve D.C. Power Unit- Manual Controls



- Pump/motor/reservoir
- Externally adjustable system relief valve
- Tandem center valve condenser equipped for synchronization with pump/motor
- .250" NPTF valve outlet ports
- Suction filter
- Rod and ball handle
- Horizontal mounting
- 4-way function, power up - power down

Part No.	Description	Wt. (lbs.)	Cat.
PU310	6" x 9" Steel Reservoir - 1 Gallon Usable (217 in ³)	35	636 (N)
PU310LR	6-1/4" x 7" x 15" Steel Reservoir - 2.2 Gallon Usable (510 in ³)	45	636 (N)
1306505	Insulated, Fits 310LR	0.83	900 (N)
HBF 12P	Replacement Filler Cap	0.04	635 (N)
M3100	Replacement Motor - Replaces Standard 08111 Motor	16.50	600 (N)

D.C. Power Unit- No Valve



- Pump/motor/reservoir
- Externally adjustable system relief valve
- .375" NPTF outlet port
- Suction filter
- Horizontal mounting
- Includes solenoid and strap
- Pump .130 in.³/ rev 12 Volt D.C.
- No valve can be added to unit, must use external valve

Part No.	Description	Wt. (lbs.)	Cat.
PU304	6" x 9" Steel Reservoir - 1 Gallon Usable (217 in ³)	31	636 (N)
PU304LR	6-1/4" x 7" x 15" Steel Reservoir - 2.2 Gallon Usable (510 in ³)	41	636 (N)
13060510	Grounded, Fits 304LR, 319LR, 642LR	0.91	900 (N)
HBF12P	3/4" Breather Cap	0.04	636 (N)
M3100	Replacement Motor - Replaces Standard 08111 Motor	16.50	600 (N)
17757	3-Post Solenoid 12V Start	0.91	636 (N)

Pump/Motor Only D.C. Power Unit



- **Pump/motor unit only**
- Ideal for use with pre-existing reservoir and external valve
- Externally adjustable system relief valve
- .375" NPTF inlet and outlet ports
- .125" NPTF relief valve exhaust port.
- Includes solenoid and strap
- **Not a replacement motor/pump - will not fit any other units**

Part No.	Description	Wt. (lbs.)	Cat.
PU526	Pump/Motor Only No Reservoir	25	636 (N)

Directional Control Valves

Directional Control Valves

- Rated Working Pressure: 2500 PSI (172 bar)
- Max. Shock and Surge Pressure: 4000 PSI (276 bar)
- Rated Flow Capacity: up to 30 GPM (114 L/M)
- Mounting: Any Position 3 Mounting Holes for 3/8" Bolts
- Weight: 1 Spool: 13 lbs.; 2 Spool: 21 lbs.; 3 Spool: 33 lbs.
- Integral load holding check valves (prevents reverse flow through valve when shifting)
- Integral differential poppet type relief valve, adjustable (set @ 2000 PSI, 10 GPM)
- Balanced, select-fit spools (provide minimum leakage, smooth operation)

- External spool seals (permit easy replacement, reduced maintenance cost)
- In/Out 1-1/16" #12 SAE; Work Ports 1-1/16" #12 SAE or 3/4"-16 #8 SAE

Optional Features Available

- Power beyond (permits use of neutral flow at system pressure); also permits field conversion from closed center to open center (tandem) operation
- Air operated - AS1
- Cable operated: Cable Connection Kit P/N-B302890
- Other valves available. Contact customer service with your requirements.

1 Spool Directional Control Valve



VH1 Handle
Sold Separately

Part No.	# Spools	Spool Action	Power Beyond	Port Size and Type	Wt. (lbs.)	Cat.
HV13AG00DO	1	3 Way - Spring Center	None	All - 1-1/16 #12 SAE	13.08	624 (N)
HV13AG2EDO	1	3 Way - Spring Center	Yes	All - 1-1/16 #12 SAE	14.0	624 (N)
HV13PG00DO	1	3 Way - Detent Out	None	All - 1-1/16 #12 SAE	15.0	624 (N)
HV11AG00DO	1	4 Way - Spring Center	None	All - 1-1/16 #12 SAE	14.0	624 (N)
HV11AG00FO	1	4 Way - Spring Center	None	In/Out - 3/4 NPTF Cyl. 1-1/16 SAE #12	12.92	624 (N)
HV11BG00DO	1	4 Way - Center Detent	None	All - 1-1/16 #12 SAE	13.0	624 (N)
HV11AG2EDO	1	4 Way - Spring Center	Yes	All - 1-1/16 #12 SAE	14.0	624 (N)

2 Spool Directional Control Valve



VH1 Handles
Sold Separately

Part No.	# Spools	Spool Action	Power Beyond	Port Size and Type	Wt. (lbs.)	Cat.
HV233AAG2EDO	2	3 Way - Spring Center, 3 Way - Spring Center	Yes	All - 1-1/16 #12 SAE	23.5	624 (N)
HV211AAG00DO	2	4 Way - Spring Center, 4 Way - Spring Center	None	All - 1-1/16 #12 SAE	23.5	624 (N)
HV211AAG2EDO	2	4 Way - Spring Center, 4 Way - Spring Center	Yes	All - 1-1/16 #12 SAE	22.0	624 (N)
HV231AAG3EDO	2	3 Way - Spring Center, 4 Way - Spring Center	Conv.	All - 1-1/16 #12 SAE	22.75	624 (N)
HV231NAG2ECO	2	3 Way - Detent In, 4 Way - Spring Center	Yes	In/Out - 1-1/16 #12 SAE, Work - 3/4-16 #8 SAE	23.0	624 (N)

3 Spool Directional Control Valve



VH1 Handles
Sold Separately

Part No.	# Spools	Spool Action	Power Beyond	Port Size and Type	Wt. (lbs.)	Cat.
HV3331NAAG2ECO	3	3 Way - Detent In, 3 Way - Spring Center, 4 Way	Yes	In/Out - 1-1/16 #12 SAE, Work - 3/4-16 #8 SAE	29.8	624 (N)
HV3311NAAG2ECO	3	3 Way - Detent In, 4 Way - Spring Center, 4 Way	Yes	In/Out - 1-1/16 #12 SAE, Work - 3/4-16 #8 SAE	33.0	624 (N)
HV3111AAAG00DO	3	4 Way - Spring Center, 4 Way - Spring Center, 4 Way	None	All - 1-1/16 #12 SAE	33.0	624 (N)
HV3111AAAG2EDO	3	4 Way - Spring Center, 4 Way - Spring Center, 4 Way	Yes	All - 1-1/16 #12 SAE	33.0	624 (N)

Accessories for Control Valve



VH1

B302890

AS1

Part No.	Description	Wt. (lbs.)	Cat.
VH1	Handle and Linkage Assembly	0.33	633 (N)
B302890	Remote Valve Control Connection Kit	0.75	240 (N)
AS1	Single Spool Air Cylinder	1.0	646 (N)

Hydraulic Text Definitions

- Power Beyond (permits use of neutral flow at system pressure); also permits field conversion from closed center to open center (tandem) operation
- 3 Way = Power Up, Gravity Down
- 4 Way = Power Up, Power Down
- 3 Position = Spool / Handle has 3 positions: Up/Neutral/Down
- Spring Centered = Spool returns to neutral when operator releases
- Detent = Valve Spool stays in position until changed by operator
- Air Cylinder (Converts valve from manual to air operated)
- Cable Connection Kit (Converts valve from manual to cable operated)
- 1 PR = one port relief
- 2 PR = two port relief

21 GPM Valve



- All valves rated to 21 GPM Max flow
- Port sizes: IN/OUT - 3/4" straight thread 11/16-12
Work Ports - 5/8" straight thread (7/8-12)
- Valve rated to 4,300 PSI with higher pressure main relief (non-standard)
- Main relief 1,300-3,000 PSI; set at 2,150 PSI
- Port relief angle 1,900-4,300 PSI; set at 1,800 PSI
- Port relief dump 400-1,900 PSI; set at 600 PSI
- All valves have cylinder spools
- Other configurations available

Part No.	Description	GPM	Wt. (lbs.)	Cat.
203	3 Way, without Power Beyond	21	17.42	624 (N)
203D42PRPB	3 Way Detent In, 4 Way 2 Port Reliefs, Power Beyond	21	24.06	624 (N)
203D4PR42PRPB	3 Way Detent In, 4 Way Port Relief, 4 Way 2 Port Relief, Power Beyond	21	32.00	624 (N)
203PB	3 Way, Power Beyond	21	17.38	624 (N)
204	4 Way, without Power Beyond	21	17.19	624 (N)
204PB	4 Way, Power Beyond	21	17.38	624 (N)
204PR	4 Way, One Port Relief, without Power Beyond	21	17.77	624 (N)
204PRPB	4 Way, One Port Relief, Power Beyond	21	17.73	624 (N)
B303035	Valve Connection Kit	21	0.75	624 (N)

40 GPM Valve



- All valves rated to 40 GPM Max flow rating
- All ports are #16 SAE (1-5/16"-12 UNF-2B) straight thread
- Valve rated to 4,300 PSI with higher pressure main relief (non-standard)
- Main relief 1,300-3,000 PSI; set at 2,150 PSI
- Port relief angle 1,900-4,300 PSI; set at 1,800 PSI
- Port relief dump 400-1,900 PSI; set at 600 PSI
- All valves have cylinder spools
- Other configurations available

Part No.	Description	GPM	Wt. (lbs.)	Cat.
403	3 Way, Spring Center	40	31.5	624 (N)
403D44PB	3 Way Detent In, 4 Way, 4 Way, Power Beyond	40	44.5	624 (N)
403D4PR42PRPB	3 Way Detent In, 4 Way Port Relief, 4 Way 2 Port Relief, Power Beyond	40	57.1	624 (N)
403PB	3 Way, Power Beyond	40	31.2	624 (N)
404	4 Way, Spring Center	40	31.1	624 (N)
404PB	4 Way, Power Beyond	40	30.4	624 (N)
404PR	4 Way, One Port Relief	40	31.6	624 (N)
404PRPB	4 Way, One Port Relief, Power Beyond	40	31.1	624 (N)
B303036	Valve Connection Kit	40	0.75	624 (N)

Hydraulic Valve



- 3 position, 3-way with air shift 1" NPT inlet work ports, 1-1/4 NPT return to tank
 - Can also be shifted with handle (Part No. HV25H)
 - 35 gal. nominal flow rating
 - Relief valve preset @ 2,000 PSI (max allowable)
 - Compares to Gresen* Valve #AG25P3HP
 - **HV25 handle and linkage kit sold separately**
- * Buyers Products is not authorized by nor affiliated with the manufacturer of Gresen products.*

Part No.	Description	Wt. (lbs.)	Cat.
HV25	Hydraulic Valve	22.0	633 (N)
HV25H	Handle for HV25	1.10	633 (N)

Hydraulic Text Definitions

- Power Beyond (permits use of neutral flow at system pressure); also permits field conversion from closed center to open center (tandem) operation
- 3 Way = Power Up, Gravity Down
- 4 Way = Power Up, Power Down
- 3 Position = Spool / Handle has 3 positions: Up/Neutral/Down

- Spring Centered = Spool returns to neutral when operator releases
- Detent = Valve Spool stays in position until changed by operator
- Air Cylinder (Converts valve from manual to air operated)
- Cable Connection Kit (Converts valve from manual to cable operated)
- 1 PR = one port relief
- 2 PR = two port relief

Electric Sectional Valves

Electric Sectional Valves



**More Options - Call 440-299-5430
or 844-974-8324 (option 4) for availability**

- 12V, 2.4 amps per coil Rated to 11 GPM Max Flow (non proportional)
- All ports are #8 SAE straight thread
- Valve rated to 4300 PSI with higher pressure main relief (non standard)
- Main relief 1300-3000 PSI; Set at 2150 PSI
- Port relief angle 1900-4300 PSI; Set at 2150 PSI
- Port relief dump 400-1900 PSI; Set at 600 PSI
- All valves have cylinder spools unless specified as motor

Electrically Operated Sectional Valves

Part No.	Description	Wt. (lbs.)	Cat.
HVE3	3 Way	10.74	624 (N)
HVE334PB	3 Way, 3 Way, 4 Way, PB	26.00	624 (N)
HVE33PB	3 Way, 3 Way, PB	16.75	624 (N)
HVE342PRPB	3 Way, 4 Way with 2 PR, PB	16.75	624 (N)
HVE344PB	3 Way, 4 Way, 4 Way, PB	10.78	624 (N)
HVE34M	3 Way, 4 Way Motor Spool	15.50	624 (N)
HVE34M3PB	3 Way, 4 Way Motor, 3 Way, PB	26.00	624 (N)
HVE34PR3PR3PRPB	3 Way, 4 Way with 2 PR, 3 Way with PR, 3 Way with PR, PB	35.25	624 (N)
HVE342PR4PRPB	3 Way, 4 Way with 2 PR, 4 Way with PR, PB	16.00	624 (N)
HVE3PB	3 Way, PB	10.89	624 (N)
HVE4	4 Way	10.85	624 (N)
HVE42PRPB	4 Way with 2 PR, PB	11.02	624 (N)
HVE44	4 Way, 4 Way	16.60	624 (N)
HVE44PB	4 Way, 4 Way, PB	16.78	624 (N)
HVE4PB	4 Way, PB	11.00	624 (N)
HVE4PR	4 Way with 1 PR	11.17	624 (N)
HVE4PRPB	4 Way with 1 PR, PB	10.85	624 (N)

Switch Panel



- Includes 2 momentary action rockers and 1 detent rocker
- Hoist safety neutral lock out feature
- Includes body up light

Part No.	Description	Wt. (lbs.)	Cat.
HVESB	Switch Panel for Electric Sectional Valve	0.98	633 (N)

9' Harness



- Designed for electrically operated sectional valve
- Female push-on connectors for switch end
- Main power harness
- 3 conductors

Part No.	Description	Wt. (lbs.)	Cat.
HVEH9	9' Harness for Electrically Operated Sectional Valve	0.83	633 (N)

15' Harness



- Designed for electrically operated sectional valve
- DIN connectors installed for valve end

Part No.	Description	Wt. (lbs.)	Cat.
HVEH15	15' Harness for Electrically Operated Sectional Valve	3.9	639 (N)

Hydraulic Text Definitions

- Power Beyond (permits use of neutral flow at system pressure); also permits field conversion from closed center to open center (tandem) operation
- 3 Way = Power Up, Gravity Down
- 4 Way = Power Up, Power Down
- 3 Position = Spool / Handle has 3 positions: Up/Neutral/Down

- Spring Centered = Spool returns to neutral when operator releases
- Detent = Valve Spool stays in position until changed by operator
- Air Cylinder (Converts valve from manual to air operated)
- Cable Connection Kit (Converts valve from manual to cable operated)
- 1 PR = one port relief
- 2 PR = two port relief

Gate Valve



- Have a screwed bonnet, non-rising stem, solid wedge disc, and integral seats
- Recommended for non-steam use in residential and light commercial applications
- May be repacked while in service under pressure
- 200 PSI W.O.G. Non-shock

Part No.	Valve Size	Wt. (lbs.)	Cat.
HGV038	3/8"	0.50	623 (Y)
HGV050	1/2"	0.60	623 (Y)
HGV075	3/4"	0.70	623 (Y)
HGV100	1"	1.00	623 (Y)
HGV125	1-1/4"	1.60	623 (Y)
HGV150	1-1/2"	2.00	623 (Y)
HGV200	2"	2.90	623 (Y)
HGV250	2-1/2"	6.10	623 (Y)

Full Flow Ball Valve



- For control of air, water, oil & gas
- 600 PSI W.O.G. Non-shock

Part No.	PKG. Part No.	Valve Size	Wt. (lbs.)	Cat.
HBV025	60220	1/4"	0.40	622 (Y)
HBV038	60221	3/8"	0.30	622 (Y)
HBV050	60222	1/2"	0.60	622 (Y)
HBV075	60223	3/4"	0.80	622 (Y)
HBV100	-	1"	1.40	622 (Y)
HBV125	-	1-1/4"	1.94	622 (Y)
HBV150	-	1-1/2"	2.82	622 (Y)
HBV200	-	2"	5.30	622 (Y)
HBV250	-	2-1/2"	8.90	622 (Y)

2 Port High Pressure Ball Valves



- 1/4" to 1-1/4" NPTF
- Rugged carbon steel construction
- Blow out proof stems
- Buna seals standard

Part No.	Ports (High Pressure)	Thread Size	Max Working Pressure	Wt. (lbs.)	Cat.
HBVS025	2	1/4" NPTF	7250	0.77	622 (Y)
HBVS038	2	3/8" NPTF	7250	1.10	622 (Y)
HBVS050	2	1/2" NPTF	7250	1.43	622 (Y)
HBVS075	2	3/4" NPTF	5800	3.31	622 (Y)
HBVS100	2	1" NPTF	5000	4.41	622 (Y)
HBVS125	2	1.25" NPTF	5000	7.13	622 (Y)

3 Port High Pressure Ball Valves

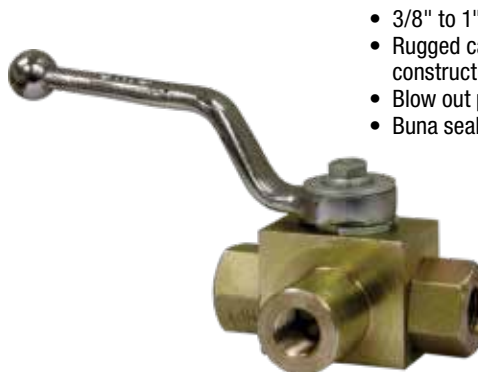

- 3/8" to 1" NPTF
- Rugged carbon steel construction
- Blow out proof stems
- Buna seals standard

Part No.	Ports (High Pressure)	Thread Size	Max Working Pressure	Wt. (lbs.)	Cat.
HBV3W038	3	3/8" NPTF	5800	0.88	622 (Y)
HBV3W050	3	1/2" NPTF	5000	1.54	622 (Y)
HBV3W075	3	3/4" NPTF	5000	3.41	622 (Y)
HBV3W100	3	1" NPTF	5000	4.62	622 (Y)

Flow Control Valves, Flow Divider & Selector Valves

Flow Control Valve



- Available in NPT and SAE
- Provide precise control of flow, and automatically permit full flow in the opposite direction.
- Cracking pressure for return check poppet: 5 PSI (0.4 Bar)
- Maximum operating pressure:
Brass: F Models, inline only: 2000 PSI (140 Bar)
Steel: 400-800 sizes: 5000 PSI; 1200 sizes: 3000 PSI

Part No.	Description	Wt. (lbs.)	Cat.
F400B	1/4" Brass Flow Control Valve, NPT	0.48	624 (N)
F400S	1/4" Steel Flow Control Valve, NPT	0.48	624 (N)
F600S	3/8" Steel Flow Control Valve, NPT	0.79	624 (N)
F800S	1/2" Steel Flow Control Valve, NPT	0.69	624 (N)
F1200S	3/4" Steel Flow Control Valve, NPT	1.10	624 (N)
F400SAE	Steel Flow Control Valve, #4 SAE	1.90	624 (N)
F600SAE	Steel Flow Control Valve, #6 SAE	1.10	624 (N)
F800SAE	Steel Flow Control Valve, #8 SAE	2.46	624 (N)
F1200SAE	Steel Flow Control Valve, #12 SAE	2.33	624 (N)

Priority Flow Divider Valve



- Maximum operating pressure: 3000 PSI
- Priority flow dividers split the oil from a single inlet into two separate flows:
 1. A controlled, adjustable flow which has priority on the oil entering the valve port closest to the adjustment dial
 2. A secondary flow based on oil in excess of that demanded by the priority flow port furthest from the adjustment dial
- Both flows may be used simultaneously at different pressures without affecting the priority flow rate
- External adjusting knob controls priority flow rate
- Load may be applied to either port without affecting priority flow rate

Part No.	Description	Wt. (lbs.)	Cat.
HFD075	3/4" NPTF; 20GPM Max Flow	4.0	633 (N)
HFD100	1" NPTF; 30GPM Max Flow	7.0	624 (N)

Side Ported Priority Flow Divider Valve



- Maximum operating pressure: 3000 PSI
- Once set, it maintains constant speed regardless of load variations. Excess flow is returned to tank or used to power another function
- Priority flow dividers split the oil from a single inlet into two separate flows:
 1. A controlled, adjustable flow which has priority on the oil entering the valve port "CF"
 2. A secondary flow based on oil in excess of that demanded by the priority flow port "EX"
- Both flows may be used simultaneously at different pressures without affecting the priority flow rate
- External lockable adjusting knob controls priority flow rate
- Load may be applied to either port without affecting priority flow rate

Part No.	Description	Wt. (lbs.)	Cat.
HFDL075	Adjustable Flow Control Valve with 3/4" NPT Ports, 0-30 GPM	8.0	624 (N)
HFDL075SAE	Adjustable Flow Control Valve with #12 SAE Ports, 0-30 GPM	10.0	624 (N)

Cross-Over Relief Valve, NPTF Ports



- Maximum operating pressure: 3000 PSI
- Cross-over type
- HCR050 set at 1000 PSI, but is adjustable between 500-1500 PSI
- HCR075 set at 1000 PSI
- NPTF ports

Part No.	Description	Wt. (lbs.)	Cat.
HCR050	Cross Over Relief Valve, 1/2" NPFT ports; 10 GPM Max Flow	7.0	624 (N)
HCR075	Cross Over Relief Valve, 3/4" NPFT ports; 20GPM Max Flow	7.0	624 (N)

Cross-Over Relief Valve, SAE Ports



- Maximum operating pressure: 3000 PSI
- Cross-over type
- Set at 2,000 PSI
- SAE ports

Part No.	Description	Wt. (lbs.)	Cat.
HCR050SAE	Cross Over Relief Valve, 1/2" SAE Ports; 10 GPM Max Flow	7.0	624 (N)

Double Check Valve



- Pilot operated
- Available with 1/2" N.P.T.F. or 1/2" SAE ports
- Working pressure: 3625 PSI / 250 BAR
- Maximum operating pressure: 4422 PSI / 315 BAR
- Cracking pressure: 72.5 PSI / 5 BAR
- Used to convert latch pin plow applications to power angle plows

Part No.	Description	Wt. (lbs.)	Cat.
HCVD08	Double Check Valve, 1/2" N.P.T.F.	3.15	624 (N)
HCVD08SAE	Double Check Valve, (1/2")#8 SAE	3.15	624 (N)

In-Line Relief Valve



- Pressure range: 1501-3000 PSI
- HRV07516 preset at 1650 PSI, HRV07518 preset at 2000 PSI, HRV10018 preset at 2000 PSI, HRV10025 preset at 2500 PSI
- Maximum operating pressure: 3000 PSI

Part No.	Description	GPM	Wt. (lbs.)	Cat.
HRV07516	#12 SAE, In-line Relief Valve	30	2.20	624 (N)
HRV07518	3/4" NPT, In-line Relief Valve	20	2.20	624 (N)
HRV10018	1" NPT, In-line Relief Valve	30	2.43	624 (N)
HRV10025	1" NPT, In-line Relief Valve	50	7.74	624 (N)

Selector Valves & Proportional Control Kits

Two Position Selector Valve



- Can be shifted under full line pressure
- Selector valves are designed with a hydraulically balanced spool that allows them to be shifted under full line pressure
- System pressure is bled off to a low pressure leg before reaching the seal, resulting in a reduced effort required to shift the spool
- The seal is operated in an unloaded condition
- Maximum operating pressure: 3000 PSI

Part No.	Description	Wt. (lbs.)	Cat.
HSV050	1/2" NPTF, 10 GPM Max Flow	7.5	624 (N)
HSV075	3/4" NPTF, 20 GPM Max Flow	7.5	624 (N)
HSV100	1" NPTF, 30 GPM Max Flow	7.5	624 (N)

Air Cylinder



*HSV1C shown
with HSV100*

- Converts HSV100 selector valve from manual operation to air actuated operation
- Mounts to knob end after removal of plastic knob

Part No.	Description	Wt. (lbs.)	Cat.
HSV1C	Double Acting Control Cylinder	2.0	646 (N)

Electric/Hydraulic Proportional Control Kit with Optional Garmin® GPS Ground Speed Antenna



*HV1030EPG shown
with GPS1*

- The SaltDogg® GPS Spreader Control provides proportional spreader operation
- The Garmin® GPS Antenna plugs in for hassle-free installation on any truck and provides exceptional spreader response
- The wire harness uses weather pack connectors for secure, corrosion free connections
- The proportional valves are housed in a protective weather enclosure for reliable service and deliver 0-7GPM (HV715EPG) or 0-10GPM (HV1030EPG) for the spinner and 0-15GPM (HV715EPG) or 0-30GPM (HV1030EPG) for the auger-conveyor circuits
- **HV715EP/HV1030EP**- 12V programmable LED display controller with detented auger-conveyor/spinner controls (GPS feature not available)
- **HV715EPG/HV1030EPG**- 3 function controller with LED display: Spinner, Auger-Conveyor, and Electric Pre-Wet with GPS feature

Part No.	Description	GPM	Wt. (lbs.)	Cat.
HV715EP	Electric Hydraulic Spreader Valve Kit, 15 Gallon	7/15	30.0	902 (N)
HV715EPG	Electric Hydraulic Spreader Control Kit with Garmin® GPS Ground Speed Antenna, 15 Gallon	7/15	31.0	902 (N)
HV1030EP	Electric Hydraulic Spreader Valve Kit, 30 Gallon	10/30	30.0	902 (N)
HV1030EPG	Electric Hydraulic Spreader Control Kit with Garmin® GPS Ground Speed Antenna, 30 Gallon	10/30	31.0	902 (N)
GPS1	GPS Ground Speed Antenna with Converter and Connector	–	1.0	902 (N)

Single Flow Hydraulic Spreader Valve



- Single flow regulator with built-in on-off control plus system relief
- Built-in differential style relief valve and on-off valve in a single compact body
- Permits easy installation with min. plumbing
- Detent hand knob for each flow control
- Easy to adjust flow, 11 positive positions
- Aluminum body
- All ports are 3/4" NPT, except 1/2" NPT spinner port
- Relief cartridge std. setting 1500 PSI (105 bar)

Part No.	Description	GPM	L/Min	PSI	BAR	Wt. (lbs.)	Cat.
HV020	Valve Only	20	76	2000	140	6.09	902 (N)
HVC020	Single Valve & Console	20	76	2000	140	19.21	902 (N)

Dual Flow Hydraulic Spreader Valve



HV715

- Dual flow regulator with built-in on-off control plus system relief
- Built-in differential style relief valve and on-off valve in a single compact body
- Permits easy installation with min. plumbing
- Detent hand knob for each flow control
- Easy to adjust flow, 11 positive positions
- Aluminum body
- All ports are 3/4" NPT, except SAE ported units which are straight thread ORB.
- Relief cartridge std. setting 1500 PSI (105 bar)

Part No.	Description	GPM	L/Min	PSI	BAR	Wt. (lbs.)	Cat.
HV715	Valve Only	7/15	83-1/4	2000	140	7.00	902 (N)
HVC715	Valve & Console	7/15	83-1/4	2000	140	20.77	902 (N)
HV715SAE	Valve Only, SAE Thds.	7/15	83-1/4	2000	140	7.00	902 (N)
HV1030	Valve Only	10/30	155	2000	140	7.50	902 (N)
HVC1030	Valve & Console	10/30	155	2000	140	21.00	902 (N)
HV1030SAE	Valve Only, SAE Thds.	10/30	155	2000	140	7.00	902 (N)
HVC1	Console Only	—	—	—	—	13.12	902 (N)

Load Sensing Spreader Valve



HV515LS

- Internal load sensing checks to communicate pressure signals to load sensing pump
- Honed and matched hardened steel working parts for long life
- Rugged, dirt tolerant, and reliable
- Adjustable and detented hand knob with min. & max. stops. Eleven positive easy to adjust positions
- Fully pressure compensated
- On/Unload lever control with detented stops
- #12 SAE O-Ring Port (auger, spinner, tank, pressure)
- #4 SAE O-Ring LS Port

Part No.	Description	GPM	L/Min	PSI	BAR	Wt. (lbs.)	Cat.
HV1030LS	Spreader Valve	10/30	151	3000	210	7.00	636 (N)
HV515LS	Spreader Valve	5/15	76	3000	210	7.00	636 (N)
HVC1	Console Only	—	—	—	—	13.12	902 (N)

Plow Coupler Drain Valve



- Relieves plow coupler pressure to disconnect plow couplers more easily
- 1/2" ORB pressure ports
- 1/4" ORB return port
- Machined billet aluminum
- Anodized finish

Part No.	Description	Wt. (lbs.)	Cat.
6241005	Plow Coupler Drain Valve	0.01	624 (N)

Quick Couplers

Wing Type Hydraulic Quick Coupler



- Solid brass coupler halves
- Ductile iron wing section

Part No.	Description	Wt. (lbs.)	Cat.
3/4" NPT Coupler (Flow Rate 18 GPM)			
QDWC12	3/4" Complete Coupler Male & Female Assemblies	2.00	647 (N)
QDWC121	3/4" Wing Type Quick Detach Coupler, Male End	0.76	647 (N)
QDWC122	3/4" Wing Type Quick Detach Coupler, Female End	1.24	647 (N)
1" NPT Coupler (Flow Rate 45 GPM)			
QDWC16	1" Complete Coupler Male & Female Assemblies	3.25	644 (N)
QDWC161	1" Wing Type Quick Detach Coupler, Male End Only	1.35	644 (N)
QDWC162	1" Wing Type Quick Detach Coupler, Female End Only	1.90	644 (N)
1-1/4" NPT Coupler (Flow Rate 75 GPM)			
QDWC20	1-1/4" Complete Coupler Male & Female Assemblies	4.50	644 (N)
QDWC201	1-1/4" Wing Type Quick Detach Coupler, Male End Only	1.70	644 (N)
QDWC202	1-1/4" Wing Type Quick Detach Coupler, Female End Only	2.80	644 (N)
1-1/2" NPT Coupler (Flow Rate 100 GPM)			
QDWC24	1-1/2" Complete Coupler Male & Female Assemblies	6.10	644 (N)
QDWC241	1-1/2" Wing Type Quick Detach Coupler, Male End	2.65	647 (N)
QDWC242	1-1/2" Wing Type Quick Detach Coupler, Female End	2.17	647 (N)

Steel Dust Cap



Part No.	Description	Wt. (lbs.)	Cat.
QDDC121	Steel Dust Cap with Chain for 3/4" NPT Coupler	0.45	647 (N)
QDDC161	Steel Dust Cap with Chain for 1" NPT Coupler	0.40	644 (N)
QDDC201	Steel Dust Cap with Chain for 1-1/4" NPT Coupler	0.55	644 (N)
QDDC241	Steel Dust Cap with Chain for 1-1/2" NPT Coupler	0.65	644 (N)

Steel Dust Plug



Part No.	Description	Wt. (lbs.)	Cat.
QDDP122	Steel Dust Plug with Chain for 3/4" NPT Coupler	0.50	647 (N)
QDDP162	Steel Dust Plug with Chain for 1" NPT Coupler	0.60	644 (N)
QDDP202	Steel Dust Plug with Chain for 1-1/4" NPT Coupler	0.70	644 (N)

Sleeve Type Hydraulic Quick Coupler





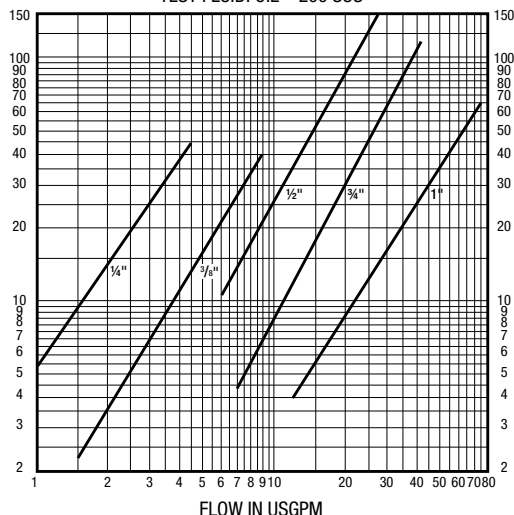

- Rugged general purpose coupler with a single acting sleeve
- Connects when system is not operating or when pressure has been relieved
- Rust resistant steel bodies

B4000 SERIES (1/4, 3/8, 1/2, 3/4, 1)

TEST FLUID: OIL – 200 SUS



Part No.	Description	Wt. (lbs.)	Cat.
B40002	1/4" NPTF Coupler Assy.	0.34	644 (N)
 60005	1/4" NPTF Coupler Assy.	0.34	644 (N)
B40003	3/8" NPTF Coupler Assy.	0.67	644 (N)
 60006	3/8" NPTF Coupler Assy.	0.67	644 (N)
B40004	1/2" NPTF Coupler Assy.	0.80	644 (N)
 60007	1/2" NPTF Coupler Assy.	0.80	644 (N)
B40005	3/4" NPTF Coupler Assy.	1.00	644 (N)
 60008	3/4" NPTF Coupler Assy.	1.00	644 (N)
B40006	1" NPTF Coupler Assy.	2.50	644 (N)

B4000 Series (1/4, 3/8, 1/2, 3/4, 1)					
	1/4"	3/8"	1/2"	3/4"	1"
Rated PSI	2500	2500	2500	2000	2000
Temp. Range	-40° to +250° F				
Valves	Ball	Ball	Ball	Ball	Poppet

Rubber Dust Plug



Part No.	Description	Wt. (lbs.)	Cat.
B40002DP	1/4" Dust Plug	0.02	644 (N)
B40003DP	3/8" Dust Plug	0.04	644 (N)
B40004DP	1/2" Dust Plug	0.04	644 (N)
B40005DP	3/4" Dust Plug	0.11	644 (N)
B40006DP	1" Dust Plug	0.11	644 (N)

Rubber Dust Cap



Part No.	Description	Wt. (lbs.)	Cat.
B40002DC	1/4" Dust Cap	0.03	644 (N)
B40003DC	3/8" Dust Cap	0.04	644 (N)
B40004DC	1/2" Dust Cap	0.04	644 (N)
B40005DC	3/4" Dust Cap	0.07	644 (N)
B40006DC	1" Dust Cap	0.14	644 (N)

Quick Couplers

Female Flush-Face Couplers



- Push to connect design, no need to retract the sleeve to connect
- Locking sleeve standard on all sizes to prevent accidental disconnection during operation
- 5,000 PSI rating and a 4 to 1 safety factor
- Very minimal spillage upon disconnection
- No air inclusion upon connection
- Comparable to Parker®, Faster®, Holmbury*, Safeway®*
- A push on "toilet seat" style dust protector for the coupler side helps keep contaminants from entering the hydraulic system
- Manufactured to ISO 16028 specifications
- Note: The standard "FF" series couplings are NOT designed to connect or disconnect under pressure even though you are able to connect the plug into the coupler with up to 200 lbs. of residual pressure

Part No.	Description	Port NPT	Wt. (lbs.)	Cat.
FF0606	3/8" Female Coupler	3/8"	0.70	644 (N)
FF0608	3/8" Female Coupler	1/2"	0.67	644 (N)
FF0808	1/2" Female Coupler	1/2"	1.19	644 (N)
FF0812	1/2" Female Coupler	3/4"	1.13	644 (N)
FF08FC	1/2" Dust Cap, Female Coupler	–	0.06	644 (N)

Male Flush-Face Couplers



- Push to connect design, no need to retract the sleeve to connect
- Locking sleeve standard on all sizes to prevent accidental disconnection during operation
- 5,000 PSI rating and a 4 to 1 safety factor
- Very minimal spillage upon disconnection
- No air inclusion upon connection
- Comparable to Parker®, Faster®, Holmbury*, Safeway®*
- A push on "toilet seat" style dust protector for the coupler side helps keep contaminants from entering the hydraulic system
- Manufactured to ISO 16028 specifications
- Note: The standard "FF" series couplings are NOT designed to connect or disconnect under pressure even though you are able to connect the plug into the coupler with up to 200 lbs. of residual pressure

Part No.	Description	Port NPT	Wt. (lbs.)	Cat.
FM0606	3/8" Male Plug	3/8"	0.42	644 (N)
FM0608	3/8" Male Plug	1/2"	0.39	644 (N)
FM0808	1/2" Male Plug	1/2"	0.72	644 (N)
FM0812	1/2" Male Plug	3/4"	0.67	644 (N)
FF08MC	1/2" Dust Cap, Male Plug	–	0.04	644 (N)

* Buyers Products is not authorized by nor affiliated with the manufacturer of Parker®, Faster®, Holmbury, or Safeway® products.

High Pressure Hose Assembly



- 1" high pressure SAE 100R2 (2 wire) hose assembly

Part No.	Description	Wt. (lbs.)	Cat.
HP1660	1" NPT x 1" NPT x 5' Long Hose Assembly	5.00	637 (N)
HP1672	1" NPT x 1" NPT x 6' Long Hose Assembly	6.00	637 (N)
HP1696	1" NPT x 1" NPT x 8' Long Hose Assembly	8.00	637 (N)
HP16108	1" NPT x 1" NPT x 9' Long Hose Assembly	9.00	637 (N)
HP16132	1" NPT x 1" NPT x 11' Long Hose Assembly	11.0	637 (N)
HP16144	1" NPT x 1" NPT x 12' Long Hose Assembly	12.0	637 (N)

Iron Reducing Bushing



Part No.	Description	Wt. (lbs.)	Cat.
RAB125075	1-1/4" Male NPT x 3/4" Female NPT	0.40	627 (N)
RAB150125	1-1/2" Male NPT x 1-1/4" Female NPT	0.30	627 (N)
RAB125100	1-1/4" Male NPT x 1" Female NPT	0.26	627 (N)
RAB200125	2" Male NPT x 1-1/4" Female NPT	0.68	627 (N)
RAB200150	2" Male NPT x 1-1/2" Female NPT	0.60	627 (N)

Suction Hose Barbed Adapter



- Hex style

Part No.	Description	Wt. (lbs.)	Cat.
BCA16180	1" Male NPT x 1" Hose Barb	0.40	627 (N)
BCA20180	1-1/4" Male NPT x 1-1/4" Hose Barb	0.75	627 (N)

Combination Nipple



- Zinc plated steel
- Machined from schedule 40 pipe
- Close tolerances and defined serrations
- Long first serration for easy installation

Part No.	Size	Male Thread	Hose I.D.	Barb End Length	Overall Length	Wt. (lbs.)	Cat.
HCN050	1/2"	.50 NPT	.50"	1.350"	3.438"	0.17	627 (N)
HCN075	3/4"	.75 NPT	.75"	1.350"	3.125"	0.20	627 (N)
HCN100	1"	1.00 NPT	1.00"	1.350"	3.250"	0.33	627 (N)
HCN125	1-1/4"	1.25 NPT	1.25"	1.650"	3.875"	0.54	627 (N)
HCN150	1-1/2"	1.50 NPT	1.50"	1.650"	4.000"	0.64	627 (N)
HCN200	2"	2.00 NPT	2.00"	2.200"	4.375"	0.98	627 (N)
HCN250	2-1/2"	2.50 NPT	2.50"	2.400"	5.500"	1.65	627 (N)
HCN300	3"	3.00 NPT	3.00"	3.000"	6.125"	2.05	627 (N)
BHES4x5 (unplated)	1-1/4"	1.00 NPT	1.25"	1.650"	3.375"	0.35	627 (N)
BHEPS4x5	1-1/4"	1.00 NPT	1.25"	1.650"	3.375"	0.50	627 (N)
BHEPS5x6	1-1/2"	1.25 NPT	1.50"	1.650"	3.500"	0.53	627 (N)
BHRPS6x5	1-1/4"	1.50 NPT	1.25"	1.650"	4.875"	0.83	627 (N)

Suction Hose



- Internally reinforced 100R4 suction or return line hose

Part No.	Description	Wt. (lbs.)	Cat.
WLH075600	3/4" I.D. x 50' hose	24.5	637 (N)
WLH100120	1" I.D. x 10' hose	7.50	637 (N)
WLH100600	1" I.D. x 50' hose	37.5	637 (N)
WLH10072	1" I.D. - 100R4 x 6'	3.00	637 (N)
WLH10096	1" I.D. x 8' hose	6.00	637 (N)
WLH12572	1-1/4" I.D. x 6' Suction Hose	6.60	637 (N)
WLH125120	1-1/4" I.D. x 10' Suction Hose	11.0	637 (N)
WLH125144	1-1/4" I.D. x 12' Suction Hose	14.0	637 (N)
WLH125600	1-1/4" I.D. x 50' Suction Hose	55.0	637 (N)

4 Bolt Flange Adapter Kit



- Converts split flange to NPT porting
- Complete with bolts, lock washers & O-ring

Part No.	Description	Wt. (lbs.)	Cat.
B431616U	1" Adapter Kit	1.51	629 (N)
B432020U	1-1/4" Adapter Kit	2.04	629 (N)
B432424U	1-1/2" Adapter Kit	3.02	629 (N)
B433232U	2" Adapter Kit	4.90	629 (N)
B434040U	2-1/2" Adapter Kit	5.06	629 (N)

Steel Check Valve



- Holds pressure in one direction and free flows in the other direction
- Available in NPT and SAE
- Female ports on each end
- 5 PSI spring
- Max pressure 4500 PSI

Part No.	Description	Wt. (lbs.)	Cat.
HCV038	Steel Check Valve, 3/8" NPT	.43	624 (N)
HCV050	Steel Check Valve, 1/2" NPT	.75	624 (N)
HCV075	Steel Check Valve, 3/4" NPT	1.15	624 (N)
HCV100	Steel Check Valve, 1" NPT	2.13	624 (N)

Filtration Kits & Return Line Manifold

3-Line Filtration Kit- 25 Micron Filter



- **Kit includes:**
- 10' return line hose with 1" diameter
- Four 1" barbed adapters
- Three 1-1/4" x 1" reducing bushings
- Four 1" hose clamps
- Return line filter with bypass
- 25 micron spin on element
- Filter-to-frame mounting bracket
- Pump/valve bypass sleeve
- For up to 3 stage telescopic cylinder

Part No.	Description	Rating	Wt. (lbs.)	Cat.
U3LWF	3-Line Kit with 25 Micron Filter	50 GPM	17	635 (N)

3-Line Filtration Kit-25 Micron High Capacity Over Under Filter



- **Kit includes:**
- 10' return line hose with 1-1/4" diameter
- Four 1-1/4" barbed adapters
- Four 1-1/4" hose clamps
- Return line filter with bypass
- Two 25 micron spin on elements
- Pump/valve bypass sleeve
- For up to 6 stage telescopic cylinder

Part No.	Description	Rating	Wt. (lbs.)	Cat.
U3LWF3	3-Line Kit with 25 Micron High Capacity Filter, Over Under	100 GPM	20	635 (N)

3-Line Filtration Kit-25 Micron High Capacity Side-by-Side Filter



- **Kit includes:**
- 10' return line hose with 1-1/4" diameter
- Four 1-1/4" barbed adapters
- Four 1-1/4" hose clamps
- Return line filter with bypass
- Two 25 micron spin on elements
- Pump/valve bypass sleeve
- For up to 6 stage telescopic cylinder

Part No.	Description	Rating	Wt. (lbs.)	Cat.
U3LWF4	3-Line Kit with 25 Micron High Capacity Filter, Side-by-Side	90 GPM	20	635 (N)

Return Line Manifold



- Used to eliminate numerous return lines back to the reservoir
- Constructed of 11 gauge steel
- Oil-fogged for maximum protection against rust before application
- Features six heavy duty forged ports: three 3/4" NPT ports, two 1" NPT ports, and a 1/4" NPT return port
- 14.5" length
- Max 50 PSI working pressure

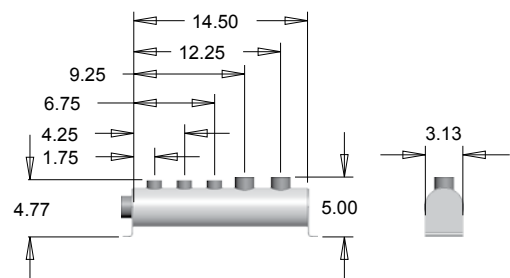

Part No.	Description	Wt. (lbs.)	Cat.
RM10	Return Line Manifold	6.80	624 (N)

Filter Element Cross Reference Chart

BUYERS	U1L3FE	U1L6FE	U3L3FE	U3L6FE
AC	PF16	PF26	PF828	
Baldwin	BT839-10	BT839-25	BT287-10	
Canflo	RSE30-10	RSE30-25	RSE50-10	RSE50-25
Case			R25844	A57857
Caterpillar			342449 or 8J1600	
Cross	1A9021	1A9023	1A9251*	1A9253*
Deere			AT44696	AT44696 or AR43261
Deluxe	WD451	WD453	WD347	
Ditch Witch	155910		155954	
Fleet Guard	LF6056		LF680	
Fram	P1653A	P1654A	PH47-10	
Gresen	K22001	K22002	K23018*	K23019*
Hastings	P731	P732	P430	
Hydra-Mac			3401-303	3401-307
Lenz	CP752-10	CP752-30	1282-10-50	
LHA	SPE15-10	SPE15-25	SPE50-10	SPE50-25
Motorcraft	FH-10	FH-11	FL275	

BUYERS	U1L3FE	U1L6FE	U3L3FE	U3L6FE
MPF	S28	S29	S58	S59
NAPA	1551	1552	1758	1759
New Holland	20932		262546	
Owatonna		170- 32375		
Parker	921999	925023	926169	926170
Pall			9500FS4UJH	
Prince	FA-10	FA-25	FB10	FB25
Purolator			R29	
Ripley	DP752-10	DP752-25		
Stieger		18-502	18-842	18-498
Tennant	52582	UCC	1500-4-10	1500-4-25
Vickers			575942 or 941107	
Wix	51551	515523	51759	
Zinga	AE10	AE25	SE10	SE25
Heil				75C425-1
Intl Harvester				69149-C1

* Should use flat seal Part No. HFFS

Buyers Products is not authorized by nor affiliated with the manufacturer's products listed above. This information is made available for the convenience of our customers and is not meant to indicate that the product is shipped to/from above companies

HFA0-Series 7 GPM Return Line Filter Assembly



- Up to 200 PSI working pressure
- Flows up to 7 GPM for return and 2 GPM for suction line applications
- 9/16"-18 UN (SAE-6) ports (FH000)
- 3/8" NPTF ports (FH001)
- 3/4" - 16 threaded neck

Part No.	Component	Description	Wt. (lbs.)	Cat.
FH000	Filter Head	9/16"-18 UN (SAE-6) No Bypass	0.58	635 (N)
FH001	Filter Head	3/8" NPTF, No Bypass	0.58	635 (N)
U0L3FE	Replacement Element	10 Micron	0.62	635 (N)

Filters

HFA1-Series 15 GPM Return Line Filter Assembly



- Up to 200 PSI working pressure
- Flows up to 15 GPM for return and 5 GPM for suction line applications
- 3/4" NPT Ports
- Two 1/8" NPT Gauge Ports
- 1" - 12 threaded neck

Part No.	Component	Description	Wt. (lbs.)	Cat.
HFA11015	Filter Assembly	10 Micron, 15 PSI Bypass	1.68	635 (N)
HFA11025	Filter Assembly	10 Micron, 25 PSI Bypass	1.68	635 (N)
HFA12515	Filter Assembly	25 Micron, 15 PSI Bypass	1.68	635 (N)
HFA12525	Filter Assembly	25 Micron, 25 PSI Bypass	1.68	635 (N)
FH115	Filter Head Only	15 PSI Bypass	0.58	635 (N)
FH125	Filter Head Only	25 PSI Bypass	0.58	635 (N)
U1L3FE	Replacement Element	10 Micron	1.10	635 (N)
U1L6FE	Replacement Element	25 Micron	1.04	635 (N)
HSP15P	Indicator Gauge	Pressure (Return Line)	0.12	635 (N)
HSP15V	Indicator Gauge	Vacuum (Suction)	0.12	635 (N)
U3L007	Filter Bracket	Filter Bracket, for FHA1 & FHA2 Series	1.30	635 (N)

HFA6-Series 15 GPM Return Line Filter Assembly



- Up to 200 PSI working pressure
- Flows up to 15 GPM for return and 5 GPM for suction line applications
- 1/2" NPT Ports
- Two 1/8" NPT Gauge Ports
- 1" - 12 threaded neck

Part No.	Component	Description	Wt. (lbs.)	Cat.
FH625	Filter Head	25 PSI Bypass	0.58	635 (N)
U1L3FE	Replacement Element	10 Micron	1.10	635 (N)
U1L6FE	Replacement Element	25 Micron	1.04	635 (N)

HFA7-Series 15 GPM Return Line Filter Assembly



- Up to 200 PSI working pressure
- Flows up to 15 GPM for return and 5 GPM for suction line applications
- 1" NPT ports
- Two 1/8" NPT gauge ports
- 1" - 12 threaded neck

Part No.	Component	Description	Wt. (lbs.)	Cat.
FH715	Filter Head Only	15 PSI Bypass Assembly	0.81	635 (N)
FH725	Filter Head Only	25 PSI Bypass Assembly	0.81	635 (N)
U1L3FE	Replacement Element	10 Micron	1.10	635 (N)
U1L6FE	Replacement Element	25 Micron	1.04	635 (N)

HFA2-Series 50 GPM Return Line Filter Assembly



- Up to 150 PSI working pressure
- Flows up to 50 GPM for return and 15 GPM for suction line applications
- 1-1/4" NPT ports
- Four 1/8" NPT gauge ports
- Dual 1- 1/2" - 16 threaded neck

Part No.	Component	Description	Wt. (lbs.)	Cat.
HFA21015	Filter Assembly	10 Micron, 15 PSI Bypass Assembly	3.48	635 (N)
HFA21025	Filter Assembly	10 Micron, 25 PSI Bypass Assembly	3.48	635 (N)
HFA22515	Filter Assembly	25 Micron, 15 PSI Bypass Assembly	3.48	635 (N)
HFA22525	Filter Assembly	25 Micron, 25 PSI Bypass Assembly	3.48	635 (N)
FH215	Filter Head Only	15 PSI Bypass	1.71	635 (N)
FH225	Filter Head Only	25 PSI Bypass	2.36	635 (N)
U3L3FE	Replacement Element	10 Micron	2.10	635 (N)
U3L6FE	Replacement Element	25 Micron	2.10	635 (N)
HSP15P	Indicator Gauge	Pressure (Return Line)	0.12	630 (N)
HSP15V	Indicator Gauge	Vacuum (Suction)	0.12	630 (N)
U3L007	Filter Bracket	Universal Filter Bracket	1.30	635 (N)

Filters

HFA3-Series 100 GPM Return Line Filter Assembly



- Up to 150 PSI working pressure
- Flows up to 100 GPM for return and 35 GPM for suction line applications
- 1-1/2" NPT Ports
- Dual 1-1/4" - 16 threaded neck

Part No.	Component	Description	Wt. (lbs.)	Cat.
HFA31015	Filter Assembly	10 Micron, 15 PSI Bypass Assembly	6.56	635 (N)
HFA31025	Filter Assembly	10 Micron, 25 PSI Bypass Assembly	6.56	635 (N)
HFA32515	Filter Assembly	25 Micron, 15 PSI Bypass Assembly	6.56	635 (N)
HFA32525	Filter Assembly	25 Micron, 25 PSI Bypass Assembly	6.56	635 (N)
FH315	Filter Head Only	15 PSI Bypass	2.31	635 (N)
FH325	Filter Head Only	25 PSI Bypass	2.31	635 (N)
U3L3FE	Replacement Element	10 Micron	2.10	635 (N)
U3L6FE	Replacement Element	25 Micron	2.10	635 (N)
HSP15P	Indicator Gauge	Pressure (Return Line)	0.12	630 (N)
HSP15V	Indicator Gauge	Vacuum (Suction)	0.12	630 (N)
U3L007	Filter Bracket	Filter Bracket, for FHA1 & FHA2 Series	1.30	635 (N)

HFA4-Series 90 GPM Return line Filter Assembly



- Up to 150 PSI working pressure
- Flows up to 90 GPM for return and 20 GPM for suction line applications
- Both 1-1/2" NPT and 2" SAE Ports for each
- Dual 1-1/2" - 16 threaded necks

Part No.	Component	Description	Wt. (lbs.)	Cat.
HFA41015	Filter Assembly	10 Micron, 15 PSI Bypass Assembly	9.56	635 (N)
HFA41025	Filter Assembly	10 Micron, 25 PSI Bypass Assembly	9.56	635 (N)
HFA42515	Filter Assembly	25 Micron, 15 PSI Bypass Assembly	9.56	635 (N)
HFA42525	Filter Assembly	25 Micron, 25 PSI Bypass Assembly	9.56	635 (N)
FH415	Filter Head Only	15 PSI Bypass	5.28	635 (N)
FH425	Filter Head Only	25 PSI Bypass	5.59	635 (N)
U3L3FE	Replacement Element	10 Micron	2.10	635 (N)
U3L6FE	Replacement Element	25 Micron	2.10	635 (N)
HSP15P	Indicator Gauge	Pressure (Return Line)	0.12	630 (N)
HSP15V	Indicator Gauge	Vacuum (Suction)	0.12	630 (N)

HFA5-Series 50 GPM In-Tank Filter

- In tank filter assembly
- Up to 100 PSI working pressure
- Flows up to 50 GPM
- For use with mineral & petroleum based fluids
- Elements replaceable through filter cover
- Operating temperature -22°F to +212°F (-30°C to +100°C)
- Aluminum casting & Buna-N-seals
- 1-1/4" NPT inlet port

Part No.	Component	Description	Wt. (lbs.)	Cat.
HFA51025	Filter Assembly	10 Micron 25 PSI Bypass	6.35	635 (N)
HFA52525	Filter Assembly	25 Micron 25 PSI Bypass	6.07	635 (N)
U5L3FE	Replacement Element	10 Micron Element Only (for HFA5 Series)	1.09	635 (N)
U5L6FE	Replacement Element	25 Micron Element Only (for HFA5 Series)	1.09	635 (N)
HSP15P	Indicator Gauge	Pressure (Return Line)	0.12	630 (N)

HFA9-Series 26 GPM In-Tank Filter

- In tank filter assembly
- Up to 100 PSI working pressure
- Flows up to 26 GPM
- For use with mineral & petroleum based fluids
- Elements replaceable through filter cover
- Operating temperature -22°F to +212°F (-30°C to +100°C)
- Aluminum casting & Buna-N-seals
- 1" NPT inlet port

Part No.	Component	Description	Wt. (lbs.)	Cat.
HFA91025	Filter Assembly	10 Micron, 25 PSI Bypass, 26 GPM	2.80	630 (N)
HFA92525	Filter Assembly	25 Micron, 25 PSI Bypass, 40 GPM	2.60	630 (N)
U9L3FE	Replacement Element	10 Micron Element Only (for HFA9 Series)	0.48	630 (N)
U9L6FE	Replacement Element	25 Micron Element Only (for HFA9 Series)	0.48	630 (N)

Clamps

Weldable Heavy Duty Series Pipe Clamp



HDSSCP125

Part No.	Description	Pipe I.D.	Wt. (lbs.)	Cat.
HDSSCP012	Heavy Duty Series Clamp for Pipe	1/8"	0.17	634 (N)
HDSSCP025	Heavy Duty Series Clamp for Pipe	1/4"	0.21	634 (N)
HDSSCP038	Heavy Duty Series Clamp for Pipe	3/8"	0.20	634 (N)
HDSSCP050	Heavy Duty Series Clamp for Pipe	1/2"	0.24	634 (N)
HDSSCP075	Heavy Duty Series Clamp for Pipe	3/4"	0.29	634 (N)
HDSSCP100	Heavy Duty Series Clamp for Pipe	1"	0.41	634 (N)
HDSSCP125	Heavy Duty Series Clamp for Pipe	1-1/4"	0.40	634 (N)

Weldable Twin Pipe Clamp



TSCP125

Part No.	Description	Pipe I.D.	Wt. (lbs.)	Cat.
TSCP025	Twin Series Clamp for Pipe	1/4"	0.29	634 (N)
TSCP038	Twin Series Clamp for Pipe	3/8"	0.31	634 (N)
TSCP050	Twin Series Clamp for Pipe	1/2"	0.38	634 (N)
TSCP075	Twin Series Clamp for Pipe	3/4"	0.43	634 (N)
TSCP100	Twin Series Clamp for Pipe	1"	0.63	634 (N)
TSCP125	Twin Series Clamp for Pipe	1-1/4"	0.59	634 (N)

Weldable Hose Clamp



SSCH100

Part No.	Description	Hose I.D.	O.D.	Wt. (lbs.)	Cat.
SSCH025	Standard Series Clamp for Hose	1/4"	.619	0.22	634 (N)
SSCH038	Standard Series Clamp for Hose	3/8"	.777	0.24	634 (N)
SSCH050	Standard Series Clamp for Hose	1/2"	.908	0.38	634 (N)
SSCH062	Standard Series Clamp for Hose	5/8"	1.034	0.29	634 (N)
SSCH075	Standard Series Clamp for Hose	3/4"	1.19	0.28	634 (N)
SSCH100	Standard Series Clamp for Hose	1"	1.531	0.42	634 (N)

Weldable Twin Hose Clamp



TSCH100

Part No.	Description	Hose I.D.	O.D.	Wt. (lbs.)	Cat.
TSCH025	Twin Series Clamp for Hose	1/4"	.619	0.28	634 (N)
TSCH038	Twin Series Clamp for Hose	3/8"	.777	0.39	634 (N)
TSCH050	Twin Series Clamp for Hose	1/2"	.908	0.24	634 (N)
TSCH062	Twin Series Clamp for Hose	5/8"	1.034	0.49	634 (N)
TSCH075	Twin Series Clamp for Hose	3/4"	1.19	0.48	634 (N)
TSCH100	Twin Series Clamp for Hose	1"	1.531	0.60	634 (N)

Weldable Tubing Clamp



SSCT025

Part No.	Description	Clamp I.D.	Wt. (lbs.)	Cat.
SSCT025	Standard Series Clamp for Tubing	1/4"	0.18	634 (N)
SSCT038	Standard Series Clamp for Tubing	3/8"	0.17	634 (N)
SSCT050	Standard Series Clamp for Tubing	1/2"	0.21	634 (N)
SSCT062	Standard Series Clamp for Tubing	5/8"	0.21	634 (N)
SSCT075	Standard Series Clamp for Tubing	3/4"	0.26	634 (N)
SSCT100	Standard Series Clamp for Tubing	1"	0.24	634 (N)
SSCT125	Standard Series Clamp for Tubing	1-1/4"	0.41	634 (N)

Weldable Heavy Duty Tubing Clamp



HDSSCT125

Part No.	Description	Clamp I.D.	Wt. (lbs.)	Cat.
HDSSCT025	Heavy Duty Series Clamp for Tubing	1/4"	0.18	634 (N)
HDSSCT031	Heavy Duty Series Clamp for Tubing	5/16"	0.20	634 (N)
HDSSCT038	Heavy Duty Series Clamp for Tubing	3/8"	0.17	634 (N)
HDSSCT050	Heavy Duty Series Clamp for Tubing	1/2"	0.21	634 (N)
HDSSCT125	Heavy Duty Series Clamp for Tubing	1-1/4"	0.41	634 (N)

Weldable Twin Tubing Clamp



TSCT025

Part No.	Description	Clamp I.D.	Wt. (lbs.)	Cat.
TSCT025	Twin Series Clamp for Tubing	1/4"	0.21	634 (N)
TSCT038	Twin Series Clamp for Tubing	3/8"	0.20	634 (N)
TSCT062	Twin Series Clamp for Tubing	5/8"	0.30	634 (N)
TSCT075	Twin Series Clamp for Tubing	3/4"	0.38	634 (N)
TSCT087	Twin Series Clamp for Tubing	7/8"	0.57	634 (N)
TSCT100	Twin Series Clamp for Tubing	1"	0.37	634 (N)
TSCT125	Twin Series Clamp for Tubing	1-1/4"	0.63	634 (N)

Weldable Pipe Clamp



SSCP125

Part No.	Description	Pipe I.D.	Wt. (lbs.)	Cat.
SSCP038	Standard Series Clamp for Pipe	3/8"	0.20	634 (N)
SSCP050	Standard Series Clamp for Pipe	1/2"	0.24	634 (N)
SSCP075	Standard Series Clamp for Pipe	3/4"	0.29	634 (N)
SSCP100	Standard Series Clamp for Pipe	1"	0.41	634 (N)
SSCP125	Standard Series Clamp for Pipe	1-1/4"	0.40	634 (N)

Hose Clete, T-Bolt & Hose Clamps

T-Bolt Hose Clamp



- Heat treated 1/4"-28 UNF-3A plated steel T-bolts with plated steel locknuts
- A stainless steel welded liner closes the opening between clamp ends during tightening
- A smooth inner band prevents hoses from being cut or bulging and allows greater torquing capability than conventional worm gear clamps
- The band also assures equalized 360° clamping force around the hose for tight connections
- HC095 and HC100 do not have floating bridge

Part No.	Nom DIA.	Min DIA.	Max DIA.	Wt. (lbs.)	Cat.
HC095	1"	1.16"	1.38"	0.13	625 (N)
HC100	1-1/2"	1.25"	1.49"	0.12	625 (N)
HC125	1-3/4"	1.55"	1.79"	0.14	625 (N)
HC130	2"	1.73"	1.97"	0.14	625 (N)
HC150	2-1/8"	1.86"	2.17"	0.14	625 (N)
HC155	2-1/4"	2.03"	2.34"	0.14	625 (N)
HC160	2-3/8"	2.16"	2.47"	0.15	625 (N)
HC165	2-1/2"	2.20"	2.51"	0.15	625 (N)
HC200	2-9/16"	2.34"	2.65"	0.15	625 (N)
HC205	2-5/8"	2.41"	2.72"	0.15	625 (N)
HC210	2-3/4"	2.53"	2.84"	0.15	625 (N)
HC215	2-7/8"	2.66"	2.97"	0.15	625 (N)
HC220	3"	2.78"	3.09"	0.15	625 (N)
HC250	3-1/8"	2.91"	3.22"	0.15	625 (N)
HC260	3-1/4"	3.03"	3.34"	0.15	625 (N)
HC270	3-3/8"	3.16"	3.47"	0.15	625 (N)
HC280	3-1/2"	3.28"	3.59"	0.17	625 (N)
HC295	3-5/8"	3.41"	3.72"	0.17	625 (N)
HC300	3-3/4"	3.53"	3.84"	0.17	625 (N)
HC310	3-7/8"	3.66"	3.97"	0.18	625 (N)
HC400	4"	3.78"	4.09"	0.18	625 (N)
HC410	4-1/4"	4.03"	4.34"	0.18	625 (N)
HC500	5"	4.78"	5.09"	0.19	625 (N)
HC600	6"	5.78"	6.09"	0.20	625 (N)

Hose Clamp



- Zinc plated C-1008-1010 steel construction
- 1/32" thick black vinyl cushion
- **Packaged in quantities of 25 pieces**

Part No.	Clamping DIA	Bolt Hole	Wt. (lbs.)	Cat.
HK0509	1/4"	1/4"	0.28	634 (N)
HK0709	3/8"	9/32"	0.32	634 (N)
HK0809	7/16"	9/32"	0.50	634 (N)
HK0913	1/2"	13/32"	0.04	634 (N)
HK1013	9/16"	13/32"	0.98	634 (N)
HK1113	5/8"	13/32"	1.06	634 (N)
HK1213	11/16"	13/32"	1.14	634 (N)
HK1313	3/4"	13/32"	1.22	634 (N)
HK1413	13/16"	13/32"	1.30	634 (N)
HK1513	7/8"	13/32"	1.22	634 (N)
HK1713	1"	13/32"	1.45	634 (N)
HK1813	1-1/16"	13/32"	1.32	634 (N)
HK1913	1-1/8"	13/32"	1.64	634 (N)
HK2017	1-3/16"	17/32"	2.30	634 (N)
HK2117	1-1/4"	17/32"	2.40	634 (N)
HK2317	1-3/8"	17/32"	2.60	634 (N)
HK2517	1-1/2"	17/32"	2.74	634 (N)
HK2917	1-3/4"	17/32"	3.12	634 (N)
HK3117	1-7/8"	17/32"	3.32	634 (N)
HK3317	2"	17/32"	3.52	634 (N)
HK3417	2-5/32"	17/32"	3.76	634 (N)
HK3817	2-5/8"	17/32"	4.50	634 (N)

Steel Pipe Fittings

- **Typical Applications:** Grease, instrumental and most hydraulic systems
- **Pressure:** Up to 3000 PSI depending on pipe size
- **Sealing Method:** 1-piece tapered pipe, dryseal (NPTF)
- **Vibration Rating:** Fair resistance
- **Material:** Carbon steel – AISI/ SAE 12L14
- **Advantages:** Dryseal pipe threads (NPTF), zinc plate, compact size, broad selection of styles and sizes.
- **Conformance:** Meets SAE specifications

Pipe Size	1/16"	1/8"	1/4"	3/8"	1/2"	3/4"	1"	1-1/4"	1-1/2"	2"
Thread Size	1/16 – 27	1/8 – 27	1/4 – 28	3/8 – 18	1/2 – 14	3/4 – 14	1 – 11½	1-1/4 – 11-1/2	1-1/2 – 11-1/2	2-11-1/2

Reducer Bushing



Part No.	① Male Pipe Thread	② Female Pipe Thread	Cat.
H3109X4X2	1/4"	1/8"	627 (N)
H3109X6X2	3/8"	1/8"	627 (N)
H3109X6X4	3/8"	1/4"	627 (N)
H3109X8X2	1/2"	1/8"	627 (N)
H3109X8X4	1/2"	1/4"	627 (N)
H3109X8X6	1/2"	3/8"	627 (N)
H3109X12X4	3/4"	1/4"	627 (N)
H3109X12X6	3/4"	3/8"	627 (N)
H3109X12X8	3/4"	1/2"	627 (N)
H3109X16X6	1"	3/8"	627 (N)
H3109X16X8	1"	1/2"	627 (N)
H3109X16X12	1"	3/4"	627 (N)
H3109X20X12	1-1/4"	3/4"	627 (N)
H3109X20X16	1-1/4"	1"	627 (N)
H3109X24X20	1-1/2"	1-1/4"	627 (N)

Hex Socket Plug



Part No.	Male Pipe Thread	Cat.
H3169X2	1/8"	627 (N)
H3169X4	1/4"	627 (N)

Square Head Plug



Part No.	Male Pipe Thread	Cat.
H3179X2	1/8"	627 (N)
H3179X4	1/4"	627 (N)
H3179X6	3/8"	627 (N)
H3179X8	1/2"	627 (N)
H3179X12	3/4"	627 (N)
H3179X16	1"	627 (N)

Adapter



Part No.	① Female Pipe Thread	② Male Pipe Thread	Cat.
H3209X8X4	1/2"	1/4"	627 (N)
H3209X8X6	1/2"	3/8"	627 (N)
H3209X12X8	3/4"	1/2"	627 (N)
H3209X16X12	1"	3/4"	627 (N)

Straight Thread O-Ring Adapter



Part No.	① Male Straight Thread	② Female Pipe Thread	Cat.
H3269X6X4	3/8"	1/4"	627 (N)
H3269X6X6	3/8"	3/8"	627 (N)
H3269X8X4	1/2"	1/4"	627 (N)
H3269X8X6	1/2"	3/8"	627 (N)
H3269X8X8	1/2"	1/2"	627 (N)
H3269X10X4	5/8"	1/4"	627 (N)
H3269X10X6	5/8"	3/8"	627 (N)
H3269X10X8	5/8"	1/2"	627 (N)
H3269X10X12	5/8"	3/4"	627 (N)
H3269X12X8	3/4"	1/2"	627 (N)
H3269X12X12	3/4"	3/4"	627 (N)
H3269X16X8	1"	1/2"	627 (N)
H3269X16X12	1"	3/4"	627 (N)
H3269X16X16	1"	1"	627 (N)
H3269X20X16	1-1/4"	1"	627 (N)
H3269X20X20	1-1/4"	1-1/4"	627 (N)

Hex Head Plug



Part No.	Male Pipe Thread	Cat.
H3159X2	1/8"	627 (N)
H3159X4	1/4"	627 (N)
H3159X6	3/8"	627 (N)
H3159X8	1/2"	627 (N)
H3159X12	3/4"	627 (N)
H3159X16	1"	627 (N)

Hex Nipple



Part No.	① Male Pipe Thread	② Male Pipe Thread	Cat.
H3069X2	1/8"	1/8"	627 (N)
H3069X4X2	1/4"	1/8"	627 (N)
H3069X4	1/4"	1/4"	627 (N)
H3069X6X4	3/8"	1/4"	627 (N)
H3069X6	3/8"	3/8"	627 (N)
H3069X8X4	1/2"	1/4"	627 (N)
H3069X8X6	1/2"	3/8"	627 (N)
H3069X8	1/2"	1/2"	627 (N)
H3069X12X8	3/4"	1/2"	627 (N)
H3069X12	3/4"	3/4"	627 (N)
H3069X16	1"	1"	627 (N)
H3069X20	1-1/4"	1-1/4"	627 (N)

Steel Pipe Fittings

Coupling



Part No.	⓪Female Pipe Thread	ⓁFemale Pipe Thread	Cat.
H3309X2	1/8"	1/8"	627 (N)
H3309X4	1/4"	1/4"	627 (N)
H3309X6X4	3/8"	1/4"	627 (N)
H3309X6	3/8"	3/8"	627 (N)
H3309X8X6	1/2"	3/8"	627 (N)
H3309X8	1/2"	1/2"	627 (N)
H3309X12	3/4"	3/4"	627 (N)
H3309X16	1"	1"	627 (N)

45° Street Elbow



Part No.	⓪Male Pipe Thread	ⓁFemale Pipe Thread	Cat.
H3359X2	1/8"	1/8"	627 (N)
H3359X4	1/4"	1/4"	627 (N)
H3359X6	3/8"	3/8"	627 (N)
H3359X8	1/2"	1/2"	627 (N)
H3359X12	3/4"	3/4"	627 (N)
H3359X16	1"	1"	627 (N)

90° Street Elbow

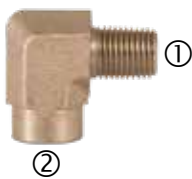

Part No.	⓪Male Pipe Thread	ⓁFemale Pipe Thread	Cat.
H3409X2	1/8"	1/8"	627 (N)
H3409X4	1/4"	1/4"	627 (N)
H3409X6	3/8"	3/8"	627 (N)
H3409X8	1/2"	1/2"	627 (N)
H3409X12	3/4"	3/4"	627 (N)
H3409X16	1"	1"	627 (N)
H3409X20	1-1/4"	1-1/4"	627 (N)

90° Elbow



Part No.	⓪Female Pipe Thread	ⓁFemale Pipe Thread	Cat.
H3509X2	1/8"	1/8"	627 (N)
H3509X4	1/4"	1/4"	627 (N)
H3509X6	3/8"	3/8"	627 (N)
H3509X8	1/2"	1/2"	627 (N)
H3509X12	3/4"	3/4"	627 (N)
H3509X16	1"	1"	627 (N)
H3509X20	1-1/4"	1-1/4"	627 (N)

90° Male Pipe Elbow



Part No.	⓪Male Pipe Thread	ⓁMale Pipe Thread	Cat.
H3529X4	1/4"	1/4"	627 (N)
H3529X6	3/8"	3/8"	627 (N)
H3529X8	1/2"	1/2"	627 (N)
H3529X12	3/4"	3/4"	627 (N)
H3529X16	1"	1"	627 (N)

45° Elbow



Part No.	⓪Female Pipe Thread	ⓁFemale Pipe Thread	Cat.
H3559X12	3/4"	3/4"	627 (N)

Male Branch Tee

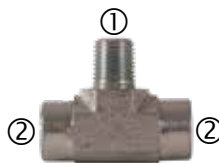

Part No.	⓪Male Pipe Thread	ⓁFemale Pipe Thread	Cat.
H3609X4	1/4"	1/4"	627 (N)
H3609X8	1/2"	1/2"	627 (N)
H3609X12	3/4"	3/4"	627 (N)

Tee



Part No.	Female Pipe Thread	Cat.
H3709X2	1/8"	627 (N)
H3709X4	1/4"	627 (N)
H3709X6	3/8"	627 (N)
H3709X8	1/2"	627 (N)
H3709X12	3/4"	627 (N)
H3709X16	1"	627 (N)
H3709X20	1-1/4"	627 (N)

Male Run Tee

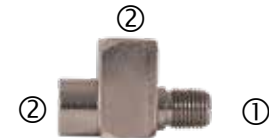

Part No.	⓪Male Pipe Thread	ⓁFemale Pipe Thread	Cat.
H3759X4	1/4"	1/4"	627 (N)
H3759X6	3/8"	3/8"	627 (N)
H3759X8	1/2"	1/2"	627 (N)
H3759X12	3/4"	3/4"	627 (N)
H3759X16	1"	1"	627 (N)

Straight Thread O-Ring Hex Socket Plug

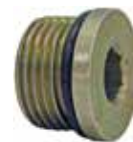

Part No.	Port Size	Cat.
H7238X2	1/8"	627 (N)
H7238X4	1/4"	627 (N)
H7238X6	3/8"	627 (N)
H7238X8	1/2"	627 (N)
H7238X10	5/8"	627 (N)
H7238X12	3/4"	627 (N)
H7238X16	1"	627 (N)
H7238X20	1-1/4"	627 (N)

Tube Fittings J.I.C. 37

- **Typical Applications:** Hydraulic, instrumentation and chemical processing systems
- **Pressure:** Up to 10,000 PSI depending on tube size
- **Sealing Method:** 3-piece flare
- **Vibration Rating:** Good resistance
- **Material:** Carbon steel – AISI/ SAE 12L14
- **Used With:** Copper, brass, steel, aluminum and other tubing that can be flared
- **Advantages:** Zinc plate. Broad selection of styles and sizes. Interchangeable with all sources
- **Identifying Characteristics:** Short nut with sleeve protruding. Material is generally steel
- **Conformance:** Meets J.I.C., SAE (J154) Standards

Tube O.D.	1/8"	3/16"	1/4"	5/16"	3/8"	1/2"	5/8"	3/4"	7/8"	1"	1-1/4"	1-1/2"	2"
Thread	5/16 – 24	3/8 – 24	7/16" – 20	1/2 – 20	9/16" – 18	3/4 – 16	7/8" – 14	11/16 – 12	13/16 – 12	15/16" – 12	1-5/8" – 12	1-7/8 – 12	2 – 1/2-12

Reducer



Part No.	Tube Reduction	Cat.
H5015X6X4	3/8" to 1/4"	627 (N)
H5015X8X4	1/2" to 1/4"	627 (N)
H5015X8X6	1/2" to 3/8"	627 (N)
H5015X16X12	1" to 3/4"	627 (N)

Sleeve 3-Piece



Part No.	Tube O.D.	Cat.
H5165X4	1/4"	627 (N)
H5165X6	3/8"	627 (N)
H5165X8	1/2"	627 (N)
H5165X10	5/8"	627 (N)
H5165X12	3/4"	627 (N)
H5165X16	1"	627 (N)

Plug



Part No.	Tube O.D.	Cat.
H5229X4	1/4"	627 (N)
H5229X5	5/16"	627 (N)
H5229X6	3/8"	627 (N)
H5229X8	1/2"	627 (N)
H5229X10	5/8"	627 (N)
H5229X12	3/4"	627 (N)
H5229X16	1"	627 (N)
H5229X20	1-1/4"	627 (N)

Nut



Part No.	Tube O.D.	Cat.
H5105X4	1/4"	627 (N)
H5105X6	3/8"	627 (N)
H5105X8	1/2"	627 (N)
H5105X10	5/8"	627 (N)
H5105X12	3/4"	627 (N)
H5105X14	7/8"	627 (N)

Male Connector



Part No.	① Tube O.D.	② Pipe Thread	Cat.
H5205X4	1/4"	1/8"	627 (N)
H5205X4X4	1/4"	1/4"	627 (N)
H5205X4X6	1/4"	3/8"	627 (N)
H5205X4X8	1/4"	1/2"	627 (N)
H5205X6X2	3/8"	1/8"	627 (N)
H5205X6	3/8"	1/4"	627 (N)
H5205X6X6	3/8"	3/8"	627 (N)
H5205X6X8	3/8"	1/2"	627 (N)
H5205X8	1/2"	3/8"	627 (N)
H5205X8X8	1/2"	1/2"	627 (N)
H5205X8X12	1/2"	3/4"	627 (N)
H5205X10	5/8"	1/2"	627 (N)
H5205X10X12	5/8"	3/4"	627 (N)
H5205X12X8	3/4"	1/2"	627 (N)
H5205X12	3/4"	3/4"	627 (N)
H5205X12X16	3/4"	1"	627 (N)
H5205X16X12	1"	3/4"	627 (N)
H5205X16	1"	1"	627 (N)
H5205X20	1-1/4"	1-1/4"	627 (N)

Rigid Female Pipe to Male JIC



Part No.	① Tube O.D.	② Female Pipe Thread	Cat.
H5255X6	3/8"	1/4"	627 (N)
H5255X8X8	1/2"	1/2"	627 (N)

Cap



Part No.	Tube O.D.	Cat.
H5129X4	1/4"	627 (N)
H5129X5	5/16"	627 (N)
H5129X6	3/8"	627 (N)
H5129X8	1/2"	627 (N)
H5129X10	5/8"	627 (N)
H5129X12	3/4"	627 (N)
H5129X14	7/8"	627 (N)
H5129X16	1"	627 (N)
H5129X20	1-1/4"	627 (N)

Small Hex Union



Part No.	① Tube O.D.	② Tube O.D.	Cat.
H5305X4	1/4"	1/4"	627 (N)
H5305X6	3/8"	3/8"	627 (N)
H5305X8	1/2"	1/2"	627 (N)
H5305X10	5/8"	5/8"	627 (N)
H5305X12	3/4"	3/4"	627 (N)

Tube Fittings J.I.C. 37

Straight Thread O-Ring Connector



Part No.	①Tube O.D.	②Port Size	Cat.
H5315X4	1/4"	1/4"	627 (N)
H5315X4X6	1/4"	3/8"	627 (N)
H5315X6X4	3/8"	1/4"	627 (N)
H5315X6	3/8"	3/8"	627 (N)
H5315X6X8	3/8"	1/2"	627 (N)
H5315X8X6	1/2"	3/8"	627 (N)
H5315X8	1/2"	1/2"	627 (N)
H5315X8X10	1/2"	5/8"	627 (N)
H5315X8X12	1/2"	3/4"	627 (N)
H5315X10X8	5/8"	1/2"	627 (N)
H5315X10	5/8"	5/8"	627 (N)
H5315X10X12	5/8"	3/4"	627 (N)
H5315X12X8	3/4"	1/2"	627 (N)
H5315X12X10	3/4"	5/8"	627 (N)
H5315X12	3/4"	3/4"	627 (N)
H5315X12X16	3/4"	1"	627 (N)
H5315X16	1"	1"	627 (N)
H5315X16X20	1"	1-1/4"	627 (N)

Bulkhead Union



Part No.	Tube O.D.	Cat.
H5325X4	1/4"	627 (N)
H5325X6	3/8"	627 (N)
H5325X8	1/2"	627 (N)
H5325X10	5/8"	627 (N)
H5325X12	3/4"	626 (N)
H5325X16	1"	627 (N)

45° Male Elbow



Part No.	①Tube O.D.	②Male Pipe Thread	Cat.
H5355X4X4	1/4"	1/4"	627 (N)
H5355X6	3/8"	1/4"	627 (N)
H5355X8	1/2"	3/8"	627 (N)
H5355X12	3/4"	3/4"	627 (N)
H5355X16	1"	1"	627 (N)

Swivel Nut 45° Elbow



Part No.	Tube O.D.	Cat.
H5356X6	3/8"	627 (N)
H5356X8	1/2"	627 (N)
H5356X10	5/8"	627 (N)
H5356X12	3/4"	626 (N)
H5356X16	1"	627 (N)

Straight Thread O-Ring 45° Elbow



Part No.	①Tube O.D.	②Port Size	Cat.
H5365X4	1/4"	1/4"	627 (N)
H5365X6	3/8"	3/8"	627 (N)
H5365X12	3/4"	3/4"	627 (N)

90° Male Elbow



Part No.	①Tube O.D.	②Male Pipe Thread	Cat.
H5405X4	1/4"	1/8"	627 (N)
H5405X4X4	1/4"	1/4"	627 (N)
H5405X6	3/8"	1/4"	627 (N)
H5405X6X6	3/8"	3/8"	627 (N)
H5405X6X8	3/8"	1/2"	627 (N)
H5405X8	1/2"	3/8"	627 (N)
H5405X8X8	1/2"	1/2"	627 (N)
H5405X8X12	1/2"	3/4"	627 (N)
H5405X10	5/8"	1/2"	627 (N)
H5405X12X8	3/4"	1/2"	627 (N)
H5405X12	3/4"	3/4"	627 (N)
H5405X16	1"	1"	627 (N)
H5405X20	1-1/4"	1-1/4"	627 (N)
H5405X24	1-1/2"	1-1/2"	627 (N)

90° Male Elbow Long



Part No.	①Tube O.D.	②Male Pipe Thread	Cat.
H5425X4X4	1/4"	1/4"	627 (N)

90° Female Elbow

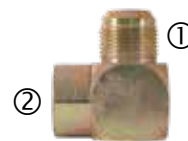

Part No.	①Tube O.D.	②Female Pipe Thread	Cat.
H5455X16	1"	1"	627 (N)

90° Union Elbow



Part No.	Tube O.D.	Cat.
H5505X12	3/4"	627 (N)

Swivel Nut 90° Elbow



Part No.	Tube O.D.	Cat.
H5506X4	1/4"	627 (N)
H5506X6	3/8"	627 (N)
H5506X8	1/2"	627 (N)
H5506X10	5/8"	627 (N)
H5506X12	3/4"	627 (N)
H5506X16	1"	627 (N)

Straight Thread O-Ring 90° Elbow



Part No.	① Tube O.D.	② Port Size	Cat.
H5515X6	3/8"	3/8"	627 (N)
H5515X6X8	3/8"	1/2"	627 (N)
H5515X8X6	1/2"	3/8"	627 (N)
H5515X8	1/2"	1/2"	627 (N)
H5515X8X10	1/2"	5/8"	627 (N)
H5515X10	5/8"	5/8"	627 (N)
H5515X12	3/4"	3/4"	627 (N)
H5515X16	1"	1"	627 (N)

Bulkhead Union Elbow



Part No.	Tube O.D.	Cat.
H5525X8	1/2"	627 (N)

Union Tee



Part No.	Tube O.D.	Cat.
H5705X6	3/8"	627 (N)
H5705X8	1/2"	627 (N)

Swivel Nut Run Tee



Part No.	Tube O.D.	Cat.
H5706X8	1/2"	627 (N)
H5706X12	3/4"	627 (N)
H5706X16	1"	627 (N)

Swivel Nut Branch Tee



Part No.	Tube O.D.	Cat.
H5707X8	1/2"	627 (N)

Straight Thread O-Ring Branch Tee



Part No.	① Tube O.D.	② Port Size	Cat.
H5715X6	3/8"	3/8"	627 (N)

Straight Thread O-Ring Run Tee

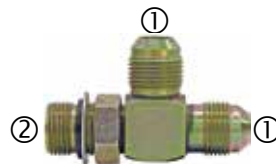

Part No.	① Tube O.D.	② Port Size	Cat.
H5716X6	3/8"	3/8"	627 (N)
H5716X8	1/2"	1/2"	627 (N)

Bulkhead Run Tee



Part No.	Tube O.D.	Cat.
H5726X6	3/8"	627 (N)
H5726X8	1/2"	627 (N)

Bulkhead Nut



Part No.	① Tube O.D.	Cat.
H5924X4	1/4"	627 (N)
H5924X6	3/8"	627 (N)
H5924X8	1/2"	627 (N)
H5924X10	5/8"	627 (N)
H5924X12	3/4"	627 (N)
H5924X16	1"	627 (N)

90° Straight Thread Hose Connector



Part No.	① Male SAE Thread	② Hose I.D.	Cat.
H890X20X16	1"	1 1/4"	627 (N)

Swivel Adapters

Swivel Adapters

- **Typical Applications:** Low, medium, and high hydraulic systems.

- **Pressure:** Up to 10,000 PSI depending on size.
- **Sealing Method:** Metal to metal, 30° cone - NPSM thread.
- **Plating:** Zinc, clear dichromate finish.

Female 37° JIC Swivel to Male Pipe



Part No.	① Tube O.D.	② Male Pipe Thread	Cat.
H9100X4X4	7/16"	1/4"	627 (N)
H9100X6X6	9/16"	3/8"	627 (N)
H9100X8X8	3/4"	1/2"	627 (N)
H9100X12X12	1-1/16"	3/4"	627 (N)
H9100X16X16	1-5/16"	1"	627 (N)

Female Pipe Swivel to Male Pipe Straight



Part No.	① NPSM Swivel Nut	② Male Pipe Thread	Cat.
H9205X4X4	1/4"	1/4"	627 (N)
H9205X4X6	1/4"	3/8"	627 (N)
H9205X6X4	3/8"	1/4"	627 (N)
H9205X6X6	3/8"	3/8"	627 (N)
H9205X6X8	3/8"	1/2"	627 (N)
H9205X8X6	1/2"	3/8"	627 (N)
H9205X8X8	1/2"	1/2"	627 (N)
H9205X8X12	1/2"	3/4"	627 (N)
H9205X12X8	3/4"	1/2"	627 (N)
H9205X12X12	3/4"	3/4"	627 (N)
H9205X12X16	3/4"	1"	627 (N)
H9205X16X12	1"	3/4"	627 (N)
H9205X16X16	1"	1"	627 (N)
H9205X20X20	1-1/4"	1-1/4"	627 (N)
H9205X24X24	1-1/2"	1-1/2"	627 (N)
H9205X32X32	2"	2"	627 (N)

Female Pipe Swivel to Female Pipe Straight



Part No.	① NPSM Swivel Nut	② Female Pipe Thread	Cat.
H9255X8X8	1/2"	1/2"	627 (N)
H9255X12X12	3/4"	3/4"	627 (N)
H9255X16X16	1"	1"	627 (N)

Male Straight Thread to Female Pipe Swivel 90° Elbow



Part No.	① Straight Thread	② NPSM Swivel Nut	Cat.
H9515X4X4	7/16-20	1/4-18	627 (N)
H9515X6X6	9/16-18	3/8-18	627 (N)
H9515X6X8	9/16-18	1/2-14	627 (N)
H9515X8X6	3/4-16	3/8-18	627 (N)
H9515X8X8	3/4-16	1/2-14	627 (N)
H9515X10X8	7/8-14	1/2-14	627 (N)
H9515X12X12	1-1/16 -12	3/4-14	627 (N)
H9515X16X16	1-5/16 -12	1-11½	627 (N)

Female Pipe Swivel to Male Pipe 45° Elbow



Part No.	① NPSM Swivel Nut	② Male Pipe Thread	Cat.
H9355X4X4	1/4-18	1/4-18	627 (N)
H9355X6X6	3/8-18	3/8-18	627 (N)
H9355X8X8	1/2-14	1/2-14	627 (N)
H9355X12X12	3/4-14	3/4-14	627 (N)
H9355X16X16	1-11½	1-11½	627 (N)
H9355X20X20	1¼-11½	1¼-11½	627 (N)

Female Pipe Swivel to Female Pipe 45° Elbow



Part No.	① Straight Thread	② NPSM Swivel Nut	Cat.
H9385X8X8	1/2-14	1/2-14	627 (N)
H9385X12X12	3/4-14	3/4-14	627 (N)

Female Pipe Swivel to Male Pipe Branch Tee

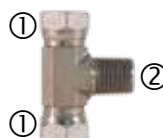

Part No.	① NPSM Swivel Nut	② Male Pipe Thread	Cat.
H9406X8X8X8	1/2-14	3/4-14	627 (N)

Female Pipe Swivel to Male Pipe 90° Elbow

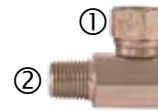

Part No.	① NPSM Swivel Nut	② Male Pipe Thread	Cat.
H9405X4X4	1/4-18	1/4-18	627 (N)
H9405X4X6	1/4-18	3/8-18	627 (N)
H9405X6X4	3/8-18	1/4-18	627 (N)
H9405X6X6	3/8-18	3/8-18	627 (N)
H9405X6X8	3/8-18	1/2-14	627 (N)
H9405X8X6	1/2-14	3/8-18	627 (N)
H9405X8X8	1/2-14	1/2-14	627 (N)
H9405X8X12	1/2-14	3/4-14	627 (N)
H9405X12X12	3/4-14	3/4-14	627 (N)
H9405X16X16	1-11½	1-11½	627 (N)
H9405X20X20	1¼-11½	1¼-11½	627 (N)

Female Pipe Swivel to Female Pipe 90° Elbow



Part No.	① NPSM Swivel Nut	② Female Pipe Thread	Cat.
H9455X8X8	1/2-14	1/2-14	627 (N)
H9455X24X24	1½-11½	1½-11½	627 (N)
H9455X32X32	2-11½	2-11½	627 (N)

Male Straight Thread to Female Pipe Swivel Straight



Part No.	① NPSM Swivel Nut	② Female Pipe Thread	Cat.
H9315X4X4	7/16"	1/4"	627 (N)
H9315X6X6	9/16"	3/8"	627 (N)
H9315X6X8	9/16"	1/2"	627 (N)
H9315X8X6	3/4"	3/8"	627 (N)
H9315X8X8	3/4"	1/2"	627 (N)
H9315X10X8	7/8"	1/2"	627 (N)
H9315X10X12	7/8"	3/4"	627 (N)
H9315X12X12	1-1/16"	3/4"	627 (N)
H9315X16X16	1-5/16"	1"	627 (N)

PNEUMATICS

Buyers Pneumatics consist of a full line of controls, valves and gauges to operate air systems.

AIR CONTROL VALVES AND CONSOLES

J2

AIR SHIFT CYLINDERS

J5

AIR TAILGATE VALVES

J6

HOSE REELS, SWITCHES, AND BREATHERS

J7

AIR VALVES, PRESSURE GAUGES, AND CONTROL ASSEMBLIES

J8

DOT AIR FITTINGS

J9

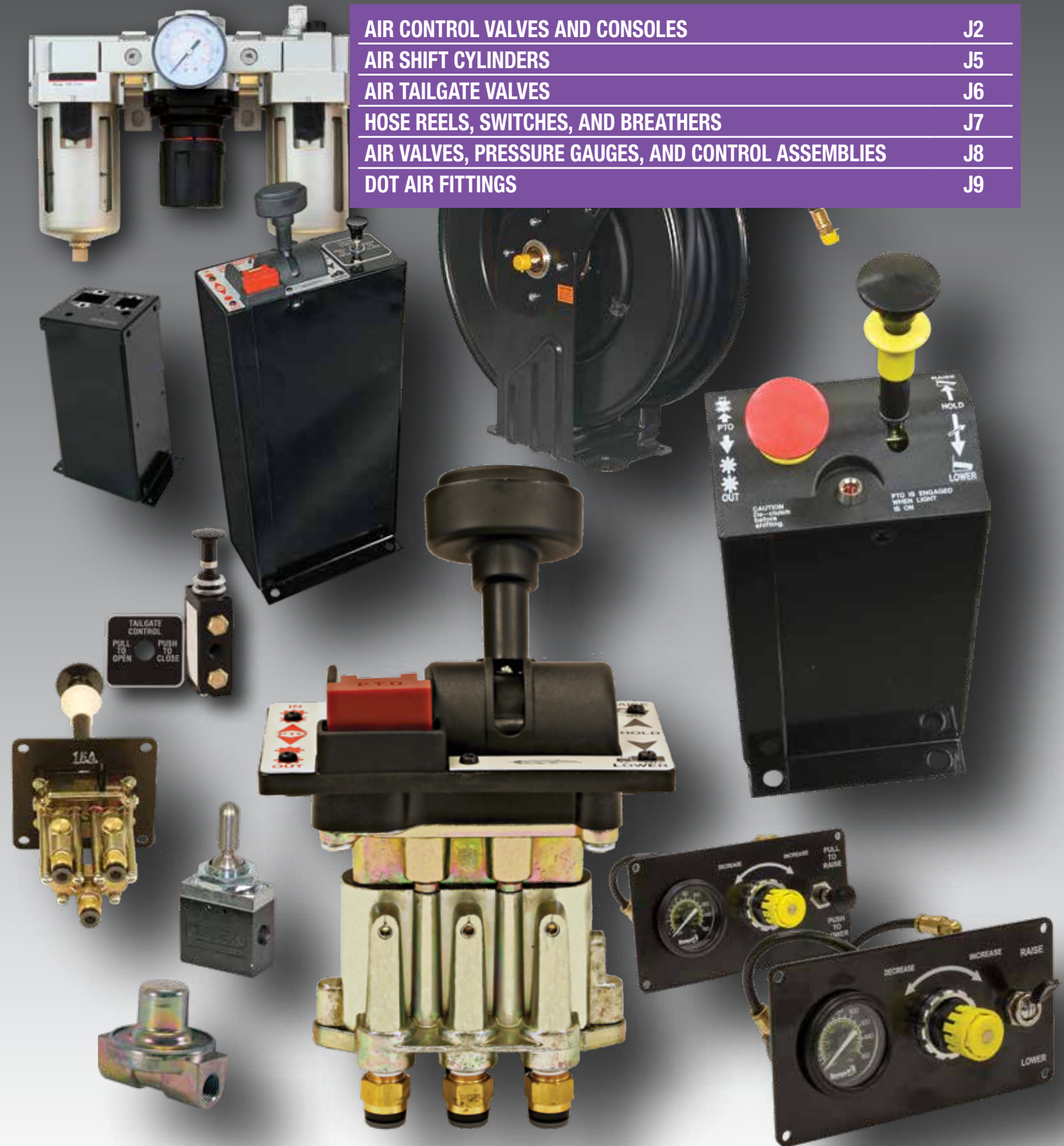

Air Control Valves & Consoles

K70 Series Single Lever Air Control Valves



- 5-way, 3-position, stackable air control valve with a push button auxiliary function
- Capable of many applications including PTO/Hoist control
- Movement of the handle in either direction allows controlled pressure output to work ports 'A' or 'B' respectively, in a proportional manner, allowing feathering
- Dual axis air control X and Y

Part No.	Description	Wt. (lbs.)	Cat.
K70DF	Valve - PTO/Hoist, Feather Down	2.60	645 (N)
K70DFD	Valve - Hoist, Feather Down, Center Detent	3.00	645 (N)
K70DFNKO	Valve - Hoist, Feather Down, Non-Disengage on PTO Function	3.00	645 (N)
K70FDA	Valve - Dual Axis, Feather, Non-Disengage	8	645 (N)
K70DETCLIP	K70 Series Valve Detent Clip	0.02	645 (N)

K80 Series Multi-Function PTO/Pump Valve



- For dump trucks, dump trailer, transfer trailer, live floor trailer, asphalt/live bottom trailer, bottom dump, side dump, platform dump, and others
- **NOTE:** White Sleeve = Feathering / Orange Sleeve = Automatic Disengage
- K80F, K80DF, K85F, K85DF provide full range feathering qualities (valve regulates pressure from 10 to 125 P.S.I.)

Part No.	Description	Color Code		Wt. (lbs.)	Cat.
		Pump Lever Sleeve	P.T.O. Lever Sleeve		
K80	Non-Feathering, Non-Disengage, Non-Return P.T.O./Pump Valve	Yellow	Yellow	2.45	645 (N)
K80D	Non-Feathering, Non-Disengage, Spring Return P.T.O./Pump Valve	Yellow	Yellow	2.45	645 (N)
K80F	Feathering, Non-Disengage, Non-Return P.T.O./Pump Valve	White	Yellow	2.65	645 (N)
K80DF	Feathering, Non-Disengage, Spring Return P.T.O./Pump Valve	White	Yellow	2.65	645 (N)
K85F	Feathering, Disengage, Non-Return P.T.O./Pump Valve	White	Orange	2.65	645 (N)
K85DF	Feathering, Disengage, Spring Return, P.T.O./Pump Valve	White	Orange	2.65	645 (N)

K90 Series Single Lever PTO/Hoist Control Valve

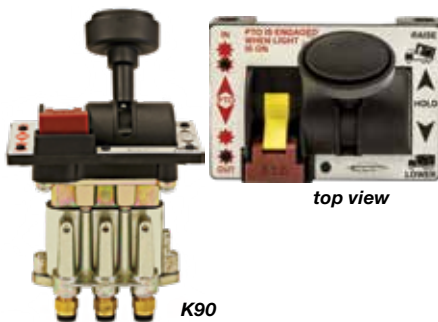

- Controlled lowering (feathering)
- Automatic disengagement of the PTO in "Lower"
- **Note: Dead Man Control** - Hoist lever returns to neutral position and stops motion when released on K90D only

Part No.	Description	Wt. (lbs.)	Cat.
K90	Standard Valve	3.16	645 (N)
K90D	Valve with Spring Return Raise (Dead Man Control)	3.16	645 (N)

Console for K70 Series Valves



- Console designed to fit the following valves: K70DF, K70DFD, K70DFNKO and K70FDA

Part No.	Description	Wt. (lbs.)	Cat.
K70C	Console for K70DF, 3-1/2 x 6-3/4 x 10"	2.75	645 (N)

Console for K80 & K90 Series Valves



- Consoles designed to fit the following valves: All K80 series, K90, K90D

Part No.	Description	Wt. (lbs.)	Cat.
K90C	Single Cabinet, 3-1/4"W x 4-3/4"D x 8"H	2.0	645 (N)
K90TC	Single Cabinet, 3-1/4"W x 4-3/4"D x 14"H	4.0	645 (N)
K90LC	Single Cabinet, 7-1/8"W x 6-1/8"D x 14-1/8"H	2.0	645 (N)
K90TGC	Console only, 3-3/8"W x 6-3/4"D x 14"H, accepts K80/K90 plus BAV010	3.5	645 (N)

Air PTO/Air Hoist Console



- Black powder coated steel console
- Top panel punched and lettered for mounting a CHELSEA type PTO air valve and a WILLIAMS type hoist air valve
- 5/8" diameter capped hole for air tailgate switch or PTO light is standard
- For blank top console see pages K6-K9

Part No.	Description	Wt. (lbs.)	Cat.
AC010	Air P.T.O./Air Hoist Console, 14-1/8" High	12.0	220 (N)

Air PTO/Air Hoist Console



- Black powder coated steel console
- Top panel punched and lettered for mounting a MUNCIE type PTO air valve and a WILLIAMS type hoist air valve
- 5/8" diameter capped hole for air tailgate switch or PTO light is standard
- For blank top console see pages K6-K9

Part No.	Description	Wt. (lbs.)	Cat.
AC010M	Air PTO/Air Hoist Console, 14-1/8" High	12.0	220 (N)
SAC010M	Air PTO/Air Hoist Console, 6-1/2" High	6.0	220 (N)

Air Control Valves

Toggle Style Air Valve Kit



- Spring return brass air feathering toggle valve
- Brass push lock fittings
- 25' x 1/4" dia. nylon D.O.T. approved tubing
- Console adapter plate
- Stainless steel finger guard

Part No.	Description	Wt. (lbs.)	Cat.
K1010TAS	Toggle Style Air Valve Kit, Momentary Switch	1.26	645 (N)

3-Way, 2-Position Air Valve



- 3-way 2-position detented
- Manual air valve used for engaging PTOs
- On/Off action only

Part No.	Description	Wt. (lbs.)	Cat.
BAV030	3-Way 2-Position, Manual Air Valve	0.90	645 (N)
BAV030B	Bulb for BAV030 Valve	0.31	639 (N)
BAV030C	Console for BAV030, 3.69" x 4.875" x 9"	0.3	645 (N)

4-Way , 3-Position Air Valve Kit



- Spring return neutral lockout air valve
- Brass push lock fittings
- 25' x 1/4" dia. tubing
- Non-feathering

Part No.	Description	Wt. (lbs.)	Cat.
K1010AS	Neutral Lockout Air Valve Kit, Non-Feathering	2.40	645 (N)
BAV040	4-Way, 3 Position Air Valve, Only, Non-Feathering	2.00	645 (N)

K1010 Series 4-Way, 3-Position Feathering Air Valve Kit



- Spring return neutral lockout feathering valve
- Brass push lock fittings
- 25' x 1/4" dia. tubing

Part No.	Description	Wt. (lbs.)	Cat.
K1010FAS	Neutral Lockout/Feathering Air Valve Kit	2.40	645 (N)
K1010FAS1	Neutral Lockout/Feathering Air Valve Only (fittings and tubing not included)	1.57	645 (N)
K1010C	Console for K1010AS and K1010FAS, 3.69" x 4.875" x 9"	5.94	645 (N)

Neutral Lockout Toggle with 3 Position Detents



Part No.	Description	Wt. (lbs.)	Cat.
BAV020TD	Toggle 3 Position Detented Valve Only	1.00	645 (N)
BAV020T	Toggle Valve Only, Momentary Switch	1.00	645 (N)

Air Shift Cylinder



AS301



AS302

- Converts manual pump operation to pneumatically controlled pump
- Complete with pump activator cylinder and mounting hardware
- Valve, tubing, fitting, and bracket kit are sold separately
- Compatible with Commercial C101/C102, Buyers BPC1010, Muncie E Series, Permco DMD25/DM640, Tyrone T101/T102*

Part No.	Description	Wt. (lbs.)	Cat.
AS301	Air Shift Cylinder	2.34	646 (N)
AS302	Air Shift Cylinder with Tubing & Fittings (NT04025 & BE90M25P125)	2.65	646 (N)

Air Shift Cylinder



- Converts manual pump operation to pneumatically controlled pump
- Complete with pump activator cylinder and mounting hardware
- Valve, tubing, fitting, and bracket kit are sold separately
- Compatible with Buyers CH101/CH102 and Commercial G101/G102*

Part No.	Description	Wt. (lbs.)	Cat.
BASK16	Air Shift Cylinder	1.43	646 (N)

Air Shift Cylinder for Hydraulic Pump



- Converts manual pump operation to pneumatically controlled pump
- Complete with pump activator cylinder and mounting hardware
- Valve, tubing, fitting, and bracket kit are sold separately
- Compatible with Buyers H101/H102, Permco DM300/DM400*

Part No.	Description	Wt. (lbs.)	Cat.
BASK16P	Air Shift Cylinder	1.38	646 (N)

* Buyers Products is not authorized by nor affiliated with the manufacturer of Commercial, Permco, Tyrone, or Muncie® products.

Air Tailgate Valves

4-Way, 2-Position Air Valve



- Panel mounted valve is ideal for operating double acting cylinders
- Mounts in dashboards or consoles
- Requires 1/2" dia. hole for mounting
- (5) 1/8" NPT ports
- Includes tailgate control faceplate
- See complete line of air tailgate cylinders on page H18

Part No.	Description	Wt. (lbs.)	Cat.
BAV010	4-Way, 2-Position Air Valve 1/8" N.P.T. Ports	0.50	645 (N)

4-Way, 3-Position Air Valve



- Detented spool allows for adjusting linkage without shutting off air pressure
- Center position blocks air at valve while opening both cylinder ports to atmosphere
- Requires 5/8" dia. hole for mounting
- (5) large 1/4" NPT ports
- Anodized aluminum

Part No.	Description	Wt. (lbs.)	Cat.
BAV015	4-Way, 3-Position Air Valve (5) 1/4" NPT Ports	0.67.	645 (N)

4-Way, 3-Position Manual Air Valve



- 3-position detented spool allows for adjusting linkage without shutting off air pressure
- Center position blocks air at valve while opening both cylinder ports to atmosphere
- (5) large 1/4" NPT ports
- Requires a 5/8" mounting hole
- Die cast zinc

Part No.	Description	Wt. (lbs.)	Cat.
BAV020	4-Way, 3-Position Air Valve; (5) 1/4" NPT Ports	1.86	645 (N)

4-Way, 2-Position Solenoid Air Valve



- (5) large 1/4" NPT ports
- Rugged 12 VDC coil comes complete with 2' flying leads
- Can be easily converted to 3-way operation by installing 2 pipe plugs

Part No.	Description	Wt. (lbs.)	Cat.
BAV050SA	4-Way, 2-Position Solenoid Valve	1.21	645 (N)

Hose Reel



- Dual pedestal base & formed support arms
- Durable black powder coat finish
- Fully enclosed heavy-duty spring
- Full flow steel axle, 90° balanced pressure, sealed brass swivel joint
- Declutching gear protects spring from reverse winding
- Four direction, anti-snag roller guide
- 1/2" Male NPT inlet & outlet
- Durable, black exterior grade hose with crimped fitting rated for 300 PSI air/water
- Maximum hose temperature 210° F/100° C

Part No.	Description	Wt. (lbs.)	Cat.
HR3850	3/8" x 50' Black Hose & Steel Reel (air/water)	49.50	570 (N)
HR1250	1/2" x 50' Black Hose & Steel Reel (air/water)	58.50	570 (N)

Filter/Regulator/Lubricator



- Compact design, 9-1/2" L x 4-1/2" W x 7-1/2" H
- Metal bowls with sight glass, quick detach
- Manual moisture drain
- Replaceable filter
- Die cast, modular design with built-in mounts
- Lubricator can be unbolted
- 50-150 PSI gauge included
- 41° F - 140° F temperature range

Part No.	Description	Wt. (lbs.)	Cat.
FRL12150	Pneumatic Filter/Reg./Lub. 1/2" NPT, 141 CFM, 150 PSI	5.30	570 (N)

Push-Pull Switch



- Normally open switch is designed to operate tailgate solenoid valves
- Can be mounted in dash-boards or consoles
- 1/2" dia. hole is required
- Tailgate control faceplate is included
- Can be used with BAV050SA

Part No.	Description	Wt. (lbs.)	Cat.
BSW050	Push-Pull Switch	0.20	645 (N)

NPT Breather Vent



- Max Pressure 150 PSI
- Max Temp 300 F
- 40 Microns

Part No.	Description	Wt. (lbs.)	Cat.
BAV02002	1/4" NPT Breather	0.57	645 (N)

Air Valves, Pressure Gauge, Control Assemblies

Universal 3-Way Toggle Valve



- (3) 1/8" NPT ports
- 174 PSI

Part No.	Description	Wt. (lbs.)	Cat.
6451000	Toggle Air Valve with Faceplate, 174 PSI, 1/8" NPT Ports	0.30	645 (N)

Pressure Protection Air Valve



- 1/4" NPT ports
- 70 PSI closing

Part No.	Description	Wt. (lbs.)	Cat.
6451005	Pressure Protection Air Valve, 70 PSI Closing; 1/4" NPT Ports	0.53	645 (N)

Universal Air Drain Valve



- Universal
- Automatic, self-closing
- 5' cable, vinyl coated
- Uncrimped end for adjustable length (clip included)
- 1/4" NPTF male thread

Part No.	Description	Wt. (lbs.)	Cat.
6451010	Universal Air Drain Valve	0.24	645 (N)

Pressure Regulator



- Relieving type
- (2) 1/8" NPTF work ports
- (2) 1/8" gauge ports
- (2) plugs
- Maximum inlet pressure: 300 PSI
- Regulating range: 2-160 PSI
- Locking knob
- Compares to Parker® #14R013FC* with #P01531* nut

Part No.	Description	Wt. (lbs.)	Cat.
6451025	Pressure Regulator	0.40	645 (N)

4 Way, 2-Position Toggle Air Valve



- (5) 1/8" NPT ports
- Commonly used with lift axle controllers
- 150 PSI
- Compares to Parker® #410811000*

Part No.	Description	Wt. (lbs.)	Cat.
6451030	Toggle Valve, 4-way, 5-port	0.50	645 (N)

Pressure Gauge



- 2" dial
- 0-160 PSI
- 1/8" NPT male
- 12 VDC backlit gauge
- Compares to Parker® #AM-2.0-150MPPM

Part No.	Description	Wt. (lbs.)	Cat.
6451035	Pressure Gauge	0.23	645 (N)

Lift Axle Control Assembly with Push-Pull Air Valve



- In-cab controls for air suspension and lift axle
- Pre-plumbed and assembled
- Fittings/DOT tubing and mounting plate included
- 7.25"L x 3.75"T steel mounting plate is pre-drilled & powder coated
- Available in single or double acting
- Individual components also available

Part No.	Description	Wt. (lbs.)	Cat.
6451050	Lift Axle Control Assy., 1/4" dia. Nylon Tubing, Single Acting	2.40	645 (N)
6451055	Lift Axle Control Assy., 3/8" dia. Nylon Tubing, Double Acting	2.50	645 (N)

Lift Axle Control Assembly with Toggle Air Valve



- In-cab controls for air suspension and lift axle
- Pre-plumbed and assembled
- Fittings/DOT tubing and mounting plate included
- 7.25"L x 3.75"T steel mounting plate is pre-drilled & powder coated
- Single acting
- Individual components also available

Part No.	Description	Wt. (lbs.)	Cat.
6451051	Lift Axle Control Assy., 1/4" dia. Nylon Tubing, Single Acting	2.43	645 (N)

* Buyers Products is not authorized by nor affiliated with the manufacturer of Parker® products.

Brass D.O.T. Push-In Air Fittings

- Brass construction
- Meet D.O.T. FMVSS 571.106 air brake performance specifications

Swivel Male Elbow



Part No.	Tube O.D.	Pipe Thread	Cat.
BE90M25P125S	1/4"	1/8"	649 (N)
BE90M25P25S	1/4"	1/4"	649 (N)
BE90M375P25S	3/8"	1/4"	649 (N)
BE90M375P375S	3/8"	3/8"	649 (N)

Male Elbow



Part No.	Tube O.D.	Pipe Thread	Cat.
BE90M25P125	1/4"	1/8"	649 (N)
BE90M25P25	1/4"	1/4"	649 (N)
BE90M375P25	3/8"	1/4"	649 (N)
BE90M375P375	3/8"	3/8"	649 (N)

D.O.T. Nylon Air Tubing



Part No.	Color	Tube O.D.	Length (ft.)	Wt (lbs.)	Cat.
NT04100	Black	1/4"	100	1.71	649 (N)
NT04250	Black	1/4"	250	3.53	649 (N)
NT06100	Black	3/8"	100	3.19	649 (N)
NT06500	Black	3/8"	500	15.5	649 (N)
NT08100	Black	1/2"	100	5.75	649 (N)
NT08500	Black	1/2"	500	22.25	649 (N)
NT10100	Black	5/8"	100	9.0	649 (N)
NT10250	Black	5/8"	250	21.2	649 (N)
NT12050	Black	3/4"	50	5.0	649 (N)
NTB04100	Blue	1/4"	100	1.22	649 (N)
NTB06100	Blue	3/8"	100	3.19	649 (N)
NTG06100	Green	3/8"	100	2.80	649 (N)
NTY04100	Yellow	1/4"	100	1.24	649 (N)
NTR04100	Red	1/4"	100	1.71	649 (N)
NTR06100	Red	3/8"	100	4.00	649 (N)

Male Connector



Part No.	Tube O.D.	Pipe Thread	Cat.
BC00M25P125	1/4"	1/8"	649 (N)
BC00M25P25	1/4"	1/4"	649 (N)
BC00M375P25	3/8"	1/4"	649 (N)
BC00M375P375	3/8"	3/8"	649 (N)

Swivel Male Branch Tee



Part No.	Tube O.D.	Pipe Thread	Cat.
BBT0M25P125S	1/4"	1/8"	649 (N)
BBT0M25P25S	1/4"	1/4"	649 (N)
BBT0M375P25S	3/8"	1/4"	649 (N)
BBT0M375P375S	3/8"	3/8"	649 (N)

Union Tee



Part No.	Tube O.D.	Cat.
BUTOP25	1/4"	649 (N)
BUTOP375	3/8"	649 (N)

Swivel Male Run Tee



Part No.	Tube O.D.	Pipe Thread	Cat.
BRT0M25P125S	1/4"	1/8"	649 (N)

Union Connector



Part No.	Tube O.D.	Cat.
BUCOP25	1/4"	649 (N)
BUCOP375	3/8"	649 (N)

Male Run Tee



Part No.	Tube O.D.	Pipe Thread	Cat.
BRT0M25P125	1/4"	1/8"	649 (N)

Brass/Poly D.O.T. Push-In Air Fittings

Brass/Poly D.O.T. Push-In Air Fittings

- Brass/Poly construction
- Meet D.O.T. FMVSS 571.106 air brake performance specifications

Union Connector



Part No.	Tube O.D.	Cat.
NUC0P25	1/4"	649 (N)
NUC0P375	3/8"	649 (N)
NUC0P500	1/2"	649 (N)
NUC0P625	5/8"	649 (N)
NUC0P750	3/4"	649 (N)

Swivel Male Elbow



Part No.	Tube O.D.	Pipe Thread	Cat.
NE90M25P125S	1/4"	1/8"	649 (N)
NE90M25P25S	1/4"	1/4"	649 (N)
NE90M375P25S	3/8"	1/4"	649 (N)
NE90M375P375S	3/8"	3/8"	649 (N)

Male Connector



Part No.	Tube O.D.	Pipe Thread	Cat.
NC00M25P125	1/4"	1/8"	649 (N)
NC00M25P25	1/4"	1/4"	649 (N)
NC00M375P25	3/8"	1/4"	649 (N)
NC00M375P375	3/8"	3/8"	649 (N)

Swivel Male Branch Tee



Part No.	Tube O.D.	Pipe Thread	Cat.
NBT0M25P125S	1/4"	1/8"	649 (N)
NBT0M25P25S	1/4"	1/4"	649 (N)
NBT0M375P375S	3/8"	3/8"	649 (N)

Swivel Male Run Tee



Part No.	Tube O.D.	Pipe Thread	Cat.
NRT0M25P125S	1/4"	1/8"	649 (N)

Union Tee



Part No.	Tube O.D.	Cat.
NUT0P25	1/4"	649 (N)
NUT0P375	3/8"	649 (N)

Union Elbow



Part No.	Tube O.D.	Cat.
NUE90P25	1/4"	649 (N)
NUE90P375	3/8"	649 (N)

CABLES & CONTROLS

Buyers Products Cables & Controls the lengths, materials and connections to fit your application needs. From shifters to valves to throttle controls and more.

CONTROL CABLES	K2
PUSH-PULL SHIFT SYSTEMS	K6
PUSH-PULL CABLES	K10
PUMP AND PTO CONNECTION KITS	K12
REMOTE VALVE CONTROL SYSTEMS	K14
KNOBS AND HARDWARE	K18
BALL JOINTS AND ROD END BEARINGS	K20
NYLON CABLE TIES	K22



Vernier Cables

3100-Series Vernier Adjustable Locking Control Cable

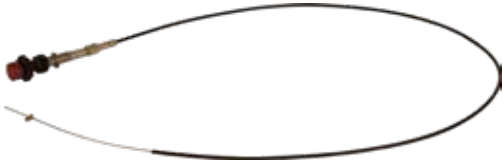

- 3/4-16 UNF head mounting thread
- .260 diameter conduit
- .075 dia. stainless steel core

Part No.	Description	Wt. (lbs.)	Cat.
VCGT3100X06	6' Vernier Adjustable Locking Control Cables	1.94	140 (Y)
VCGT3100X10	10' Vernier Adjustable Locking Control Cables	2.19	140 (Y)
VCGT3100X15	15' Vernier Adjustable Locking Control Cables	2.63	140 (Y)
VCGT3100X20	20' Vernier Adjustable Locking Control Cables	2.96	140 (Y)
VCGT3100X25	25' Vernier Adjustable Locking Control Cables	3.28	140 (Y)
VCGT3100X30	30' Vernier Adjustable Locking Control Cables	3.65	140 (Y)

4100-Series Vernier Heavy Duty Adjustable Locking Control Cable

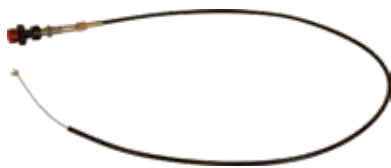

- 3/4-16 UNF head mounting thread
- .375 diameter conduit
- .088 dia. stainless steel core

Part No.	Description	Wt. (lbs.)	Cat.
VCGTX06	6' Vernier Heavy-Duty Adjustable Locking Control Cables	2.25	140 (Y)
VCGTX10	10' Vernier Heavy-Duty Adjustable Locking Control Cables	2.75	140 (Y)
VCGTX15	15' Vernier Heavy-Duty Adjustable Locking Control Cables	3.38	140 (Y)
VCGTX20	20' Vernier Heavy-Duty Adjustable Locking Control Cables	4.00	140 (Y)
VCGTX25	25' Vernier Heavy-Duty Adjustable Locking Control Cables	4.63	140 (Y)
VCGTX30	30' Vernier Heavy-Duty Adjustable Locking Control Cables	5.00	140 (Y)
VCGTX35	35' Vernier Heavy-Duty Adjustable Locking Control Cables	5.88	140 (Y)

Vernier Adjustable Locking Control Cable Replacement Head



- O-Ring sealed plunger assembly suitable for exterior applications
- Adjustable friction collet assures stable settings in the presence of severe vibration
- Dual lock balls provide increased load range & extended plunger life

Part No.	Description	Wt. (lbs.)	Cat.
VCGTH0	Vernier Cable Head Only	1.00	140 (Y)

Mack®* Replacement Stop Cable



- Designed for panels with 5/8" square mounting holes
- Easily trim to size

Part No.	Description	Wt. (lbs.)	Cat.
R109	108" Stop Cable	0.75	210 (Y)

* Buyers Products is not authorized by nor affiliated with the manufacturer of Mack® products.

Plain End Mid-Latch Control Cable with 5" Travel

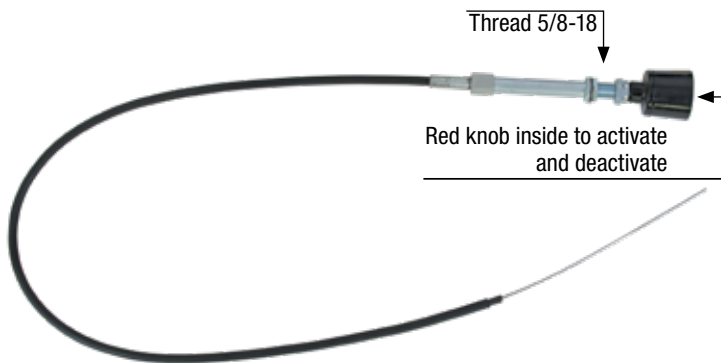

- Mid-latch controls satisfy OSHA requirements for latching hoist controls for dump body applications.
- Ideal for operating hydraulic valves and forward-reverse P.T.O.s
- 5" of total travel (2-1/2" on both sides of the center detent)
- Standard 3/8" conduit
- .091 stainless steel core wire
- Can be cut to length by the installer

Part No.	Cable Length	Wt. (lbs.)	Cat.
R38LL5X08	8'	2.53	181 (Y)
R38LL5X10	10'	2.64	181 (Y)
R38LL5X12	12'	3.20	181 (Y)
R38LL5X15	15'	3.32	181 (Y)
R38LL5X20	20'	3.97	181 (Y)

See pgs. K17-K18 for Rod and Clevis Assemblies
 See pgs. K21-K23 for Hardware & Accessories

Rod End Mid-Latch Control Cable with 3" Travel

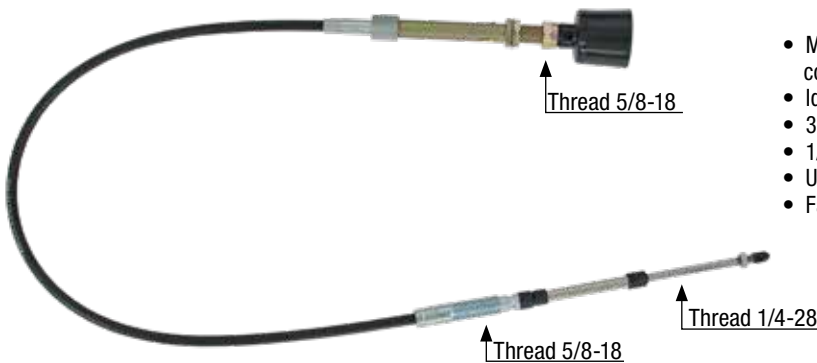

- Mid-latch controls satisfy OSHA requirements for latching hoist controls for dump body applications
- Ideal for operating hydraulic valves and forward-reverse PTOs
- 3" of total travel (1-1/2" on both sides of the center detent)
- 1/4" stainless steel output rod
- Universal style bulkhead/clamp conduit fitting
- Factory lubricated and sealed.

Part No.	Cable Length	Wt. (lbs.)	Cat.
R38LLR3X08	8'	2.70	181 (Y)
R38LLR3X10	10'	2.88	181 (Y)

See pgs. K17-K18 for Rod and Clevis Assemblies
 See pgs. K21-K23 for Hardware & Accessories

Mid-Latch Cable Controls & Valve Control Cables

R38D-Series Control Cable with 5" Travel



- Knob Part No. 65
- 3/8" - 24 THD. & 1/2" - 20 THD.
- .375 diameter conduit
- .088 diameter stainless steel core
- Long lay construction
- Includes clip as shown (Part No. 4100)

Part No.	Description	Wt. (lbs.)	Cat.
R38D6X06	6' SS Core Wire	2.13	160 (Y)
R38D6X08	8' SS Core Wire	2.13	160 (Y)
R38D6X10	10' SS Core Wire	2.34	160 (Y)
R38D6X12	12' SS Core Wire	2.75	160 (Y)
R38D6X15	15' SS Core Wire	3.00	160 (Y)
R38D6X20	20' SS Core Wire	3.63	160 (Y)
R38D6X25	25' SS Core Wire	4.25	160 (Y)
R38D6X30	30' SS Core Wire	4.88	160 (Y)

R38DR-Series Control Cable with 3" Travel

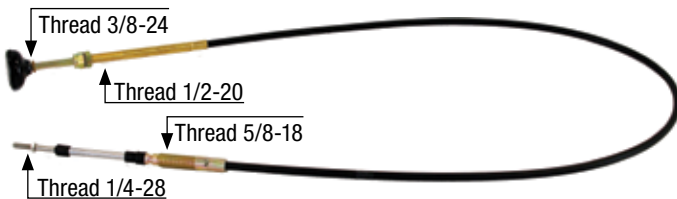

- Knob Part No. 65
- 1/2" - 20 THD., 5/8" - 18 THD., & 1/4" - 28 THD.
- .375 diameter conduit
- .088 diameter stainless steel core
- Long lay construction
- *Order nuts and washers separately. Shown with combination bulkhead and clamp mount. For bulkhead applications order BNW015 Nut & Washer Kit.*

Part No.	Description	Wt. (lbs.)	Cat.
R38DR3X04	4' SS Core Wire with Rod End Control	1.88	180 (Y)
R38DR3X06	6' SS Core Wire with Rod End Control	2.13	180 (Y)
R38DR3X08	8' SS Core Wire with Rod End Control	2.38	180 (Y)
R38DR3X10	10' SS Core Wire with Rod End Control	2.63	180 (Y)
R38DR3X12	12' SS Core Wire with Rod End Control	2.88	180 (Y)
R38DR3X15	15' SS Core Wire with Rod End Control	3.25	180 (Y)
BNW015	Nut & Washer Kit, 5/8-18	0.29	300 (N)

Customizable 2" Knob for P.T.O. and Pump Cable



Replacement Part & Accessories			
Part No.	Description	Wt. (lbs.)	Cat.
65	Imprinted Knob for PTO & Pump Cable	0.13	290 (N)

R05B-Series Control Cable with 5" Travel

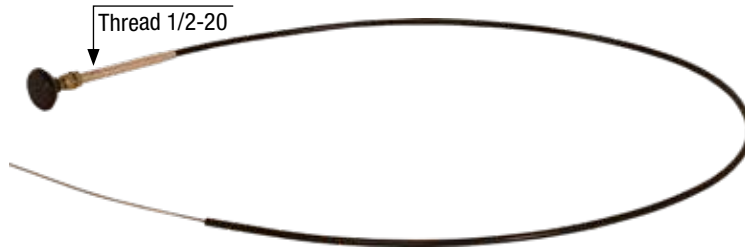

- Comparable to Chelsea® cables
- Knob Part No. 65
- 3/8" - 24 THD. & 1/2" - 20 THD
- .312 diameter spiral wound conduit
- .085 diameter stainless steel core
- *Spiral wound conduit can be cut with side cutting pliers*

Part No.	Description	Wt. (lbs.)	Cat.
R05B5X06	6' Long with 5" Travel Control Cables	1.94	161 (Y)
R05B5X10	10' Long with 5" Travel Control Cables	2.38	161 (Y)
R05B5X15	15' Long with 5" Travel Control Cables	3.05	161 (Y)

R09D-Series Control Cable with 3-1/2" Travel

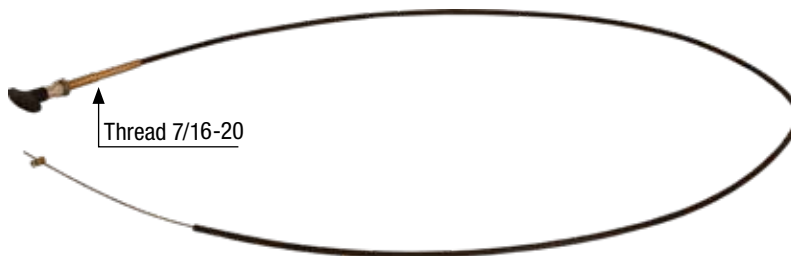

- 7/16" - 20 THD. & 1/2" - 20 THD.
- .260 diameter conduit
- .073 diameter oil tempered core

Part No.	Description	Wt. (lbs.)	Cat.
R09D3.5X06	6' Heavy-Duty T-Handle Locking Cables	1.38	150 (Y)
R09D3.5X10	10' Heavy-Duty T-Handle Locking Cables	1.63	150 (Y)
R09D3.5X15	15' Heavy-Duty T-Handle Locking Cables	2.00	150 (Y)
R09D3.5X20	20' Heavy-Duty T-Handle Locking Cables	2.38	150 (Y)
R09D3.5X25	25' Heavy-Duty T-Handle Locking Cables	2.63	150 (Y)
R09D3.5X30	30' Heavy-Duty T-Handle Locking Cables	3.13	150 (Y)

R21C-Series Choke Cable

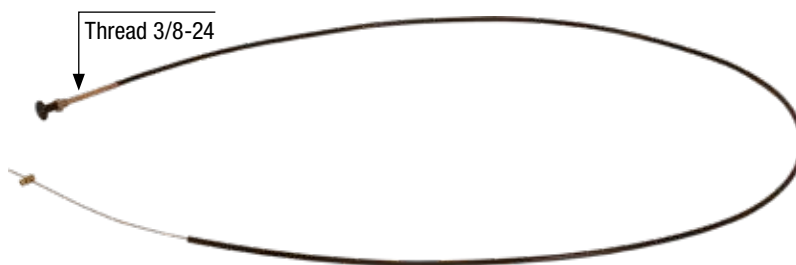

- 3/8" - 24 THD.
- .055" diameter conduit
- 2-1/2" total travel

Part No.	Description	Wt. (lbs.)	Cat.
R21CX06	6' Choke Cables	0.33	190 (Y)
R21CX08	8' Choke Cables	0.34	190 (Y)
R21CX10	10' Choke Cables	1.00	190 (Y)
R21CX15	15' Choke Cables	0.72	190 (Y)

*Buyers Products is not authorized by nor affiliated with the manufacturer of Chelsea products.

Push-Pull Shift Systems Q-Series

Q Series Single Lever Hoist Control



QSSPU52



QTS

- Hardened steel gateplates with safety detents for use with all 3" travel clamp type push-pull cables

NOTE: Levers & Consoles Sold Separately

Part No.	Description	Wt. (lbs.)	Cat.
Hoist Lever Center Detent			
QSSPU52	Hoist, Single-Lever For 1/4"-28 Thd. Cables	3.40	220 (N)
QSSPU62	Hoist, Single-Lever For 5/16"-24 Thd. Cables	3.40	220 (N)
Single Lever Console			
QTS	Black Powder Coated Steel Console For All Q-Series Single-Lever Controls	0.40	220 (N)

Q Series Triple Lever P.T.O. & Hoist Control



QTS52



QTT

- Hardened steel gateplates with safety detents for use with all 3" travel clamp type push-pull cables

NOTE: Levers & Consoles Sold Separately

Part No.	Description	Wt. (lbs.)	Cat.
P.T.O. Triple Lever Control			
QTS52	PTO – Hoist – Hoist, For 1/4"-28 Thd. Cables	11.50	220 (N)
QTS62	PTO – Hoist – Hoist, For 5/16"-24 Thd. Cables	11.50	220 (N)
P.T.O. Triple Lever Console			
QTT	Black Powder Coated Steel Console For All Q-Series Triple-Lever Controls.	11.45	220 (N)

Q Series Single Lever Pneumatic P.T.O. & Hoist Control



QSA52



QTD

- Hardened steel gateplates with safety detents for use with all 3" travel clamp type push-pull cables

NOTE: Levers & Consoles Sold Separately

Part No.	Description	Wt. (lbs.)	Cat.
Air P.T.O. Hoist Single Lever Control			
QSA62M	Single-Lever For 5/16"-24 Thd. Cables - Muncie Only	3.80	220 (N)
Air P.T.O. Single Lever Console			
QTD	Black Powder Coated Steel Console For All Q-Series Dual-Lever Controls	10.50	220 (N)

B Series Single Lever Pneumatic P.T.O. & Hoist Control



BSSPT52



BTS

NOTE: Levers & Consoles Sold Separately

Part No.	Description	Wt. (lbs.)	Cat.
P.T.O. Lever Center Detent			
BSSPT52	PTO, Single Lever End Detent for 1/4"-28 Thd. Cables	3.85	220 (N)
BSSPT62	PTO, Single Lever End Detent for 5/16"-24 Thd. Cables	3.85	220 (N)
Hoist Lever Center Detent			
BSSPU52	Hoist, Single Lever Center Detent for 1/4"-28 Thd. Cables	3.85	220 (N)
BSSPU62	Hoist, Single Lever Center Detent for 5/16"-24 Thd. Cables	3.85	220 (N)
Single Lever Console			
BTS	Black Powder Coated Steel Console for all B-Series Single Lever Controls	7.60	220 (N)

Push-Pull Shift Systems B-Series

B Series Dual Lever Control



BDS52



BTD

NOTE: Levers & Consoles Sold Separately

Part No.	Description	Wt. (lbs.)	Cat.
P.T.O. Hoist Dual Lever Control			
BDS52	PTO - Hoist, Dual Lever For 1/4"-28 Thd. Cables	7.50	220 (N)
BDS62	PTO - Hoist, Dual Lever For 5/16"-24 Thd. Cables	7.50	220 (N)
P.T.O. Dual Lever Console			
BTD	Black Powder Coated Steel Console for all B-Series Dual Lever Controls	10.00	220 (N)

B-Series Triple Lever Control



BTTT52



BTT

NOTE: Levers & Consoles Sold Separately

Part No.	Description	Wt. (lbs.)	Cat.
P.T.O. Triple Lever Control			
BTTT52	PTO - Hoist - Hoist for 1/4"-28 Thd. Cables	11.50	220 (N)
BTTT62	PTO - Hoist - Hoist for 5/16"-24 Thd. Cables	11.50	220 (N)
P.T.O. Triple Lever Console			
BTT	Black Powder Coated Steel Console for all B-Series Triple Lever Controls	11.45	220 (N)

B Series Air PTO Single Lever Control



- Used to cable actuate a hydraulic valve in vehicles equipped with a CHELSEA or MUNCIE air controlled PTO
- Controls are grouped in a single console at the operator's fingertips
- **Includes:** Airshift Mounting Kit

NOTE: Levers & Consoles Sold Separately

BA52

BTD

Part No.	Description	Wt. (lbs.)	Cat.
Air P.T.O. Hoist Single Lever Control			
BA52	Air PTO-Hoist Single Lever Hoist Control for 1/4"-28 Thd. Cables & PTO Air Valve	4.50	220 (N)
BA62	Air PTO-Hoist Single Lever Hoist Control for 5/16"-24 Thd. Cables & PTO Air Valve	4.50	220 (N)
Air P.T.O. Single Lever Console			
BTD	Black Powder Coated Steel Console for all B-Series Dual Lever Controls	10.00	220 (N)

B Series Air PTO Dual Lever Control



- Used to cable actuate two hydraulic valves in vehicles equipped with a CHELSEA or MUNCIE air controlled PTO
- **Includes:** Airshift Mounting Kit

NOTE: Levers & Consoles Sold Separately

BTA52

BTT

Part No.	Description	Wt. (lbs.)	Cat.
Air P.T.O. Hoist Dual Lever Control			
BTA52	Air PTO-Hoist-Hoist Dual Lever Hoist Control with 1/4"-28 Thd. Cables & PTO Air Valve	11.50	220 (N)
BTA62	Air PTO-Hoist-Hoist, Dual Lever Hoist Control with 5/16"-24 Thd. Cables & PTO Air Valve	11.50	220 (N)
Air P.T.O. Single Dual Console			
BTT	Black Powder Coated Steel Console for all B-Series Triple Lever Controls	11.45	220 (N)

Heavy Duty Cable Control



- Zinc plated steel construction
- Designed for use with all 2" or 3" travel rod end cables with 1/4"-28 thd., or 5/16"-24 thd. rods
- 4-position forged handle provides mounting flexibility
- An adjustable lever stop limits travel to prevent stress at output end of cable
- An ideal replacement for solid rod installations

Part No.	Description	Wt. (lbs.)	Cat.
HDCL352*	For 1/4"-28 Thd. Cables with 3" Travel	3.90	220 (N)
HDCL362*	For 5/16"-24 Thd. Cables with 3" Travel	3.90	220 (N)
HDCL252*	For 1/4"-28 Thd. Cables with 2" Travel	3.90	220 (N)
HDCL262	For 5/16"-24 Thd. Cables with 2" Travel	3.90	220 (N)

*Available with a 4" shorter lever. To order add an "S" suffix to the part number for cable selection see pgs. K14 & K15

Push-Pull Cables

5200-Series Universal Mount Control Cable



- 3" or 4" travel
- .125" cable diameter
- 1/4"-28 thread stainless steel rod
- 40 lb. - 100 lb. load range
- 8" minimum bend radius
- Stocked 3' to 20'
- Other lengths and travels available

Part No.	Description	Wt. (lbs.)	Cat.
3 Inch Travel			
5203BBU048	48" Universal Mount Control Cable with Bulkheads, Nuts & Washers	1.75	260 (Y)
5203BBU060	60" Universal Mount Control Cable with Bulkheads, Nuts & Washers	2.00	260 (Y)
5203BBU072	72" Universal Mount Control Cable with Bulkheads, Nuts & Washers	2.35	260 (Y)
5203BBU084	84" Universal Mount Control Cable with Bulkheads, Nuts & Washers	2.25	260 (Y)
5203BBU096	96" Universal Mount Control Cable with Bulkheads, Nuts & Washers	2.44	260 (Y)
5203BBU108	108" Universal Mount Control Cable with Bulkheads, Nuts & Washers	2.69	260 (Y)
5203BBU120	120" Universal Mount Control Cable with Bulkheads, Nuts & Washers	3.10	260 (Y)
5203BBU132	132" Universal Mount Control Cable with Bulkheads, Nuts & Washers	3.00	260 (Y)
5203BBU144	144" Universal Mount Control Cable with Bulkheads, Nuts & Washers	3.13	260 (Y)
5203BBU156	156" Universal Mount Control Cable with Bulkheads, Nuts & Washers	3.25	260 (Y)
5203BBU168	168" Universal Mount Control Cable with Bulkheads, Nuts & Washers	3.56	260 (Y)
5203BBU192	192" Universal Mount Control Cable with Bulkheads, Nuts & Washers	4.00	260 (Y)
5203BBU240	240" Universal Mount Control Cable with Bulkheads, Nuts & Washers	4.31	260 (Y)
4 Inch Travel			
5204BBU072	72" Universal Mount Control Cable with Bulkheads, Nuts & Washers	2.23	260 (Y)

See pgs. K21-K23 for Hardware & Accessories

ORDERING INFORMATION

Length in inches is determined by measuring overall length from one end of rod to the other end of rod.

Example:

52 03 BBU 072
 series travel type of length
 mount

5200-Series Control Cable With Clamp Mount



- 3" travel
- .125" cable diameter
- 1/4"-28 thread stainless steel rod
- 40 lb. - 100 lb. load range
- 8" minimum bend radius
- Stocked 3' to 20'
- Other lengths and travels available

Part No.	Description	Wt. (lbs.)	Cat.
5203CCU060	60" Universal Mount Control Cable with Clamp Mount	1.75	260 (Y)
5203CCU072	72" Universal Mount Control Cable with Clamp Mount	2.00	260 (Y)
5203CCU084	84" Universal Mount Control Cable with Clamp Mount	2.07	260 (Y)
5203CCU096	96" Universal Mount Control Cable with Clamp Mount	2.25	260 (Y)
5203CCU108	108" Universal Mount Control Cable with Clamp Mount	2.50	260 (Y)
5203CCU120	120" Universal Mount Control Cable with Clamp Mount	2.56	260 (Y)
5203CCU132	132" Universal Mount Control Cable with Clamp Mount	2.75	260 (Y)

See pgs. K21-K23 for Hardware & Accessories

6200-Series Universal Mount Control Cable



- 3" travel
- .188" cable diameter
- 5/16"-24 thread stainless steel rod
- 110 lb. - 200 lb. load range
- 10" minimum bend radius
- Stocked 3' to 20' in 12" increments
- Other lengths and travels available

Part No.	Description	Wt. (lbs.)	Cat.
6203BBU048	48" Universal Mount Control Cable with Bulkheads, Nuts & Washers	2.22	270 (Y)
6203BBU060	60" Universal Mount Control Cable with Bulkheads, Nuts & Washers	2.50	270 (Y)
6203BBU072	72" Universal Mount Control Cable with Bulkheads, Nuts & Washers	2.75	270 (Y)
6203BBU084	84" Universal Mount Control Cable with Bulkheads, Nuts & Washers	3.00	270 (Y)
6203BBU096	96" Universal Mount Control Cable with Bulkheads, Nuts & Washers	3.25	270 (Y)
6203BBU108	108" Universal Mount Control Cable with Bulkheads, Nuts & Washers	3.25	270 (Y)
6203BBU120	120" Universal Mount Control Cable with Bulkheads, Nuts & Washers	3.25	270 (Y)
6203BBU132	132" Universal Mount Control Cable with Bulkheads, Nuts & Washers	3.88	270 (Y)
6203BBU144	144" Universal Mount Control Cable with Bulkheads, Nuts & Washers	3.13	270 (Y)
6203BBU168	168" Universal Mount Control Cable with Bulkheads, Nuts & Washers	4.69	270 (Y)
6203BBU216	216" Universal Mount Control Cable with Bulkheads, Nuts & Washers	5.69	270 (Y)
6203BBU240	240" Universal Mount Control Cable with Bulkheads, Nuts & Washers	5.76	270 (Y)

See pgs. K21-K23 for Hardware & Accessories

ORDERING INFORMATION

Length in inches is determined by measuring overall length from one end of rod to the other end of rod.

Example:

62 03 BBU 072
 series travel type of mount length

6200-Series Control Cable with Clamp Mount



- 3" travel
- .188" cable diameter
- 5/16"-24 thread stainless steel rod
- 110 lb. - 200 lb. load range
- 10" minimum bend radius
- Stocked 3' to 20' in 12" increments
- Other lengths and travels available

Part No.	Description	Wt. (lbs.)	Cat.
6203CCU072	72" Universal Mount Control Cable with Clamp Mount	2.50	270 (Y)
6203CCU084	84" Universal Mount Control Cable with Clamp Mount	2.81	270 (Y)
6203CCU096	96" Universal Mount Control Cable with Clamp Mount	3.00	270 (Y)
6203CCU120	120" Universal Mount Control Cable with Clamp Mount	3.38	270 (Y)
6203CCU204	204" Universal Mount Control Cable with Clamp Mount	5.19	270 (Y)

See pgs. K21-K23 for Hardware & Accessories

P.T.O & Pump Connection Kits

BPT PTO Connection Kit

- For double gear CHELSEA* and similar PTOs
- Kit contains all fasteners & hardware required

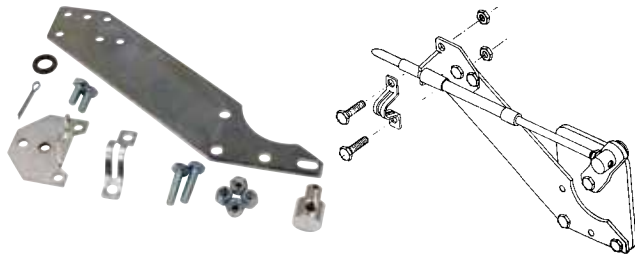

Part No.	Description	Wt. (lbs.)	Cat.
BPT	For 1/4"-28 Thd. and 5/16"-24 Thd. Control Cables	0.85	230 (N)

BPTSG PTO Connection Kit-Single Gear

- For single gear CHELSEA* and similar PTOs
- Fits all Muncie PTOs
- Kit contains all fasteners & hardware required

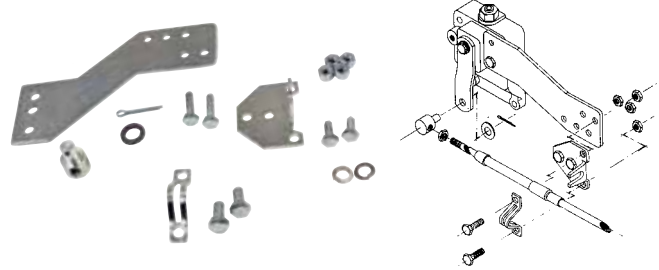

Part No.	Description	Wt. (lbs.)	Cat.
BPTSG	For 1/4"-28 Thd. and 5/16"-24 Thd. Control Cables	0.75	230 (N)

BPU Pump Connection Kit for C1010 Pump

- For BPC1010, Commercial* C101 & similar pumps
- Kit contains all fasteners & hardware required

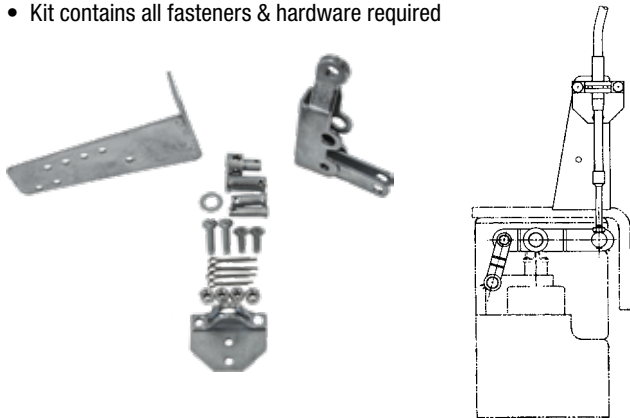

Part No.	Description	Wt. (lbs.)	Cat.
BPU	For 1/4"-28 Thd. and 5/16"-24 Thd. Control Cables	1.50	230 (N)

BPU102DM Pump Connection Kit for C1010DM Pump

- For BPC1010DM, Commercial* C102 & similar pumps
- Please specify clockwise or counterclockwise

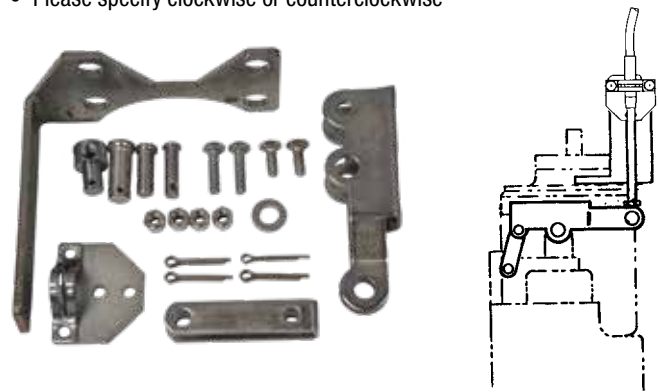

Part No.	Description	Wt. (lbs.)	Cat.
BPU102DMCW	For Clockwise Rotation	1.70	230 (N)
BPU102DMCCW	For Counterclockwise Rotation	1.70	230 (N)

BPUGD Pump Connection Kit for G101 Pump

- For Commercial* G101 remote mount pumps
- Kit contains all fasteners & hardware required

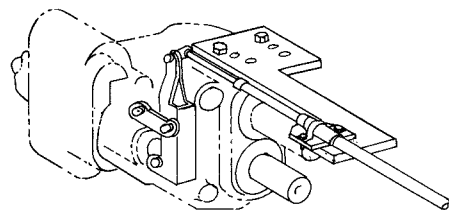

Part No.	Description	Wt. (lbs.)	Cat.
BPUGD	(Front or Rear Cable Entry) Attaches to Mounting Pad	2.65	230 (N)

BPUGDM Pump Connection Kit for G102 Pump

- For Commercial* G102 pumps

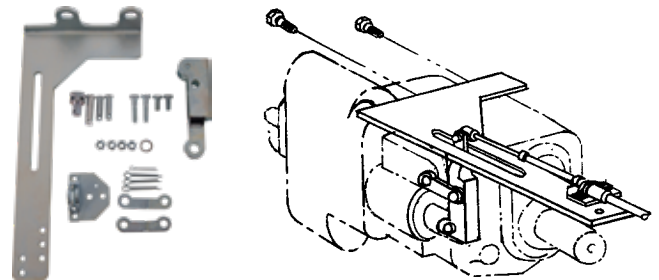

Part No.	Description	Wt. (lbs.)	Cat.
BPUGDMCW	For Clockwise Rotation	2.60	230 (N)
BPUGDMCCW	For Counterclockwise Rotation	2.60	230 (N)

* Buyers Products is not authorized by nor affiliated with the manufacturer of Chelsea® or Commercial products.

H101CK Pump Connection Kit for H101 Series Pump

- For use with Buyers H101 Series, Permco* DMR300 and DMR400 Series Remote Mount Pumps

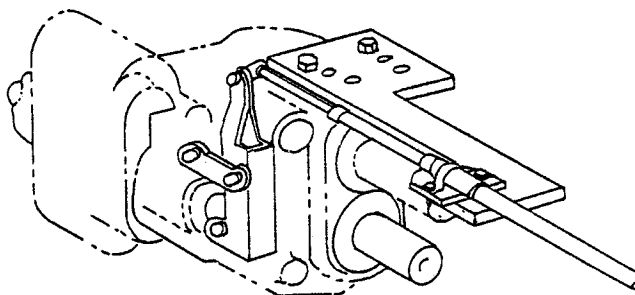

Part No.	Description	Wt. (lbs.)	Cat.
H101CK	Connection Kit	2.40	230 (N)

H102CKCW Pump Connection Kit for H102 Series Pump

- For use with Buyers H102 Series, Permco* DMD300 and DMD400 Series Direct Mount Pumps

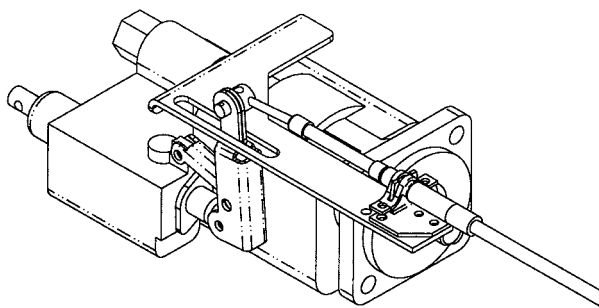

Part No.	Description	Wt. (lbs.)	Cat.
H102CKCW	For Clockwise Rotation	2.40	230 (N)
H102CKCCW	For Counterclockwise Rotation	2.40	230 (N)

BSV Pump Connection Kit for A-35 Valves

- For Commercial* A-20, A-35 & similar valves

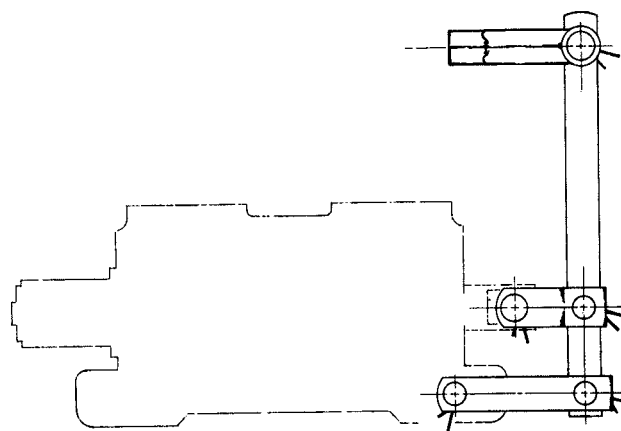

Part No.	Description	Wt. (lbs.)	Cat.
BSV3552	For A-35 Valve and 1/4"-28 Thd. Cables	1.85	230 (N)

* Buyers Products is not authorized by nor affiliated with the manufacturer of Permco® or Commercial products.

Remote Valve Control Systems

Single-Axis Remote Valve Control

- Weatherproof zinc diecast control
- Can be mounted on interior or exterior of vehicle
- Units can be mounted singly or stacked for multi-spool valves
- Valve lever has "momentary" spring to center action
- 9/16" stroke each way from center neutral position

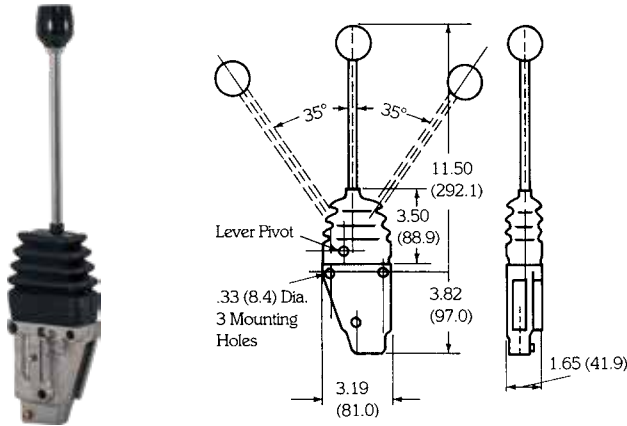

Part No.	Description	Wt. (lbs.)	Cat.
B206301	Single-Axis Remote Valve Control	2.95	240 (N)
B206301R0	Rubber Boot Cover for B20631	0.48	240 (N)

* See pg. K15 for RVC cables

Single-Axis Remote Valve Control with Detent

- Added safety feature of detents
- Weatherproof zinc diecast control
- Can be mounted on interior or exterior of vehicle
- Units can be mounted singly or stacked for multi-spool valves
- 9/16" stroke each way from center neutral position

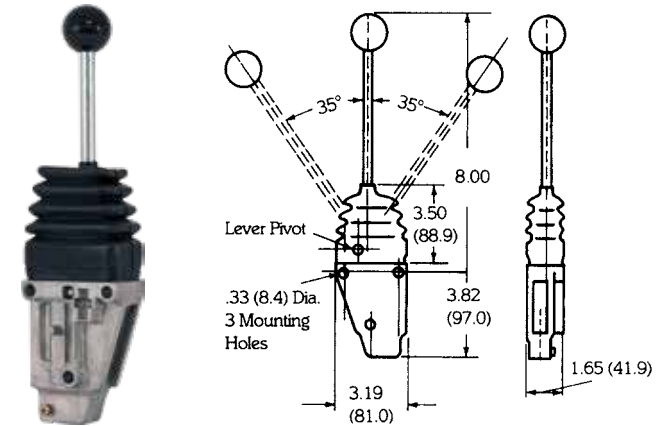

Part No.	Description	Wt. (lbs.)	Cat.
B206301001	Single-Axis Remote Valve Control with Center Detent	2.50	240 (N)
B206301002	Single-Axis Remote Valve with End Detents	2.50	240 (N)

* See pg. K15 for RVC cables

Single-Axis Remote Valve Control with Offset Handle

- Center locking or non-locking
- 70° handle, composite pivot
- For use with RVC "B302845" series cables
- Rear cable connection eliminates the need to bend cables
- Units can be mounted singly or stacked for multi-spool valves
- Knobs accept stick-on function label (VSK040)
- 9/16" stroke



Part No.	Description	Wt. (lbs.)	Cat.
B206401	Single-Axis Remote Valve Control, Non-locking, Composite, 70° Offset Handle	1.60	240 (N)
B206401001	Single-Axis Remote Valve Control, Center-locking, Composite, 70° Offset Handle	1.20	240 (N)
3014204	Mounting Brackets	0.48	240 (N)
3014332	Mounting Hardware, Single (2-1/2" Bolts)	0.13	240 (N)

* See pg. K15 for RVC cables

Dual-Axis Remote Valve Control

- Dual axis controls are used to control two valves simultaneously
- 9/16" stroke

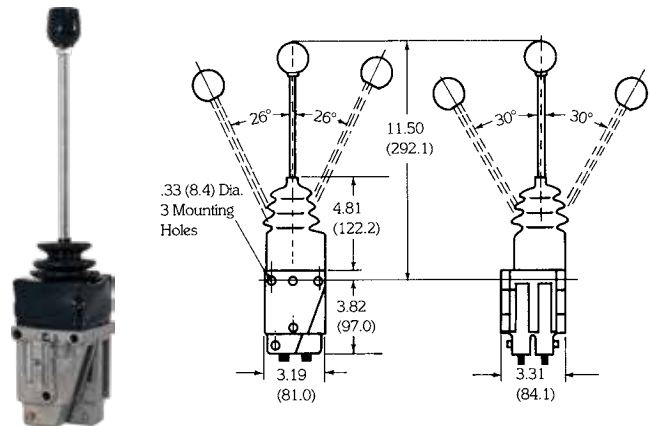

Part No.	Description	Wt. (lbs.)	Cat.
B206305	Dual Axis Remote Valve Control	4.44	240 (N)

* See pg. K15 for RVC cables

Remote Valve Control Cable

- 1.12" travel



Part No.	Description	Wt. (lbs.)	Cat.
B302845048	48" Remote Valve Control Cable	1.31	240 (N)
B302845060	60" Remote Valve Control Cable	1.41	240 (N)
B302845072	72" Remote Valve Control Cable	2.23	240 (N)
B302845084	84" Remote Valve Control Cable	2.44	240 (N)
B302845096	96" Remote Valve Control Cable	2.00	240 (N)
B302845108	108" Remote Valve Control Cable	2.07	240 (N)
B302845120	120" Remote Valve Control Cable	2.44	240 (N)
B302845132	132" Remote Valve Control Cable	2.44	240 (N)
B302845144	144" Remote Valve Control Cable	2.70	240 (N)
B302845168	168" Remote Valve Control Cable	3.25	240 (N)
B302845180	180" Remote Valve Control Cable	3.38	240 (N)

Remote Valve Control Connection Kit



- Works with any RVC controller from page K14
- Connects directly to valve spool

Part No.	Description	Wt. (lbs.)	Cat.
B303032	Gresen 25P, CP, CS, V20, V42	0.75	240 (N)
B303032	Energy CV50, CVP, CVA, 200	0.75	240 (N)
B302890	Buyers, Cross BA, BC, CA, CD	0.75	240 (N)
B303418F	Commercial A20 Front Entry	0.75	240 (N)
B303418R	Commercial A20 Rear Entry	0.75	240 (N)
B302889	Racine ML25 1/2"	0.75	240 (N)
B302889	Parker VDP12	0.75	240 (N)
B303034	Rex Roth 30-S2 MP18	0.75	240 (N)
B303035	Buyers 20-30 GPM sectional	0.75	240 (N)
B302889M	Gresen V31	0.75	240 (N)

Remote Valve Control Systems

Remote Valve Control Console



VSC1



VSC2

- Consoles are 13 gauge steel
- Black powder coated finish
- All fasteners are included

Part No.	Description	Wt. (lbs.)	Cat.
VSC1	Single Lever Console (9" H x 1-3/4" W)	3.20	240 (N)
VSC2	Dual Lever Console (9" H x 3-3/8" W)	4.25	240 (N)
VSC3	Triple Lever Console (9" H x 4-15/16" W)	4.75	240 (N)
VSC4	Quad Lever Console (9" H x 6-9/16" W)	6.00	240 (N)

Universal Control Console & Side Mount Accessory Plate



AC010B



BC12914



ACC01

- Black powder coated steel console
- Unpunched top panel for mounting air valves, electric switches, gauges, etc

ACC01:

- Designed to mount on all Buyers consoles
- Existing mounting holes are utilized to add capacity to shift consoles
- Ideal for mounting switches, gauges, etc.

Part No.	Description	Wt. (lbs.)	Cat.
ACC01	Side Mount Accessory Plate	0.5	220 (N)
AC010B	Blank Console, 7" W x 6-1/8" D x 14-1/8" H	12.0	220 (N)
SAC010B	Blank Console, 7" W x 6-1/8" D x 6-1/2" H	6.0	220 (N)
BC12914	Blank Console, 12" W x 9" D x 14" H	28.0	220 (N)
AC010B3	Blank Console, 7" W x 1" D x 6" H	1.46	220 (N)

Remote Valve Control Knob



Part No.	Description	Wt. (lbs.)	Cat.
VSK001	Black knob, 3/8-24 Thd.	0.13	290 (N)

Remote Valve Decal Sheet for Control Knob



Part No.	Description	Wt. (lbs.)	Cat.
VSK040	Decal sheet, for VSK001	0.13	290 (N)

Knobs & Hardware

Customizable 2" Knob For PTO and Pump Cables

- 3/8"-24 Thd. or 1/4"-28 Thd.



Part No.	Description	Wt. (lbs.)	Cat.
65	Plain, 3/8"-24 Thd.	0.13	290 (N)
651	Lettered "PTO", 3/8"-24 Thd.	0.13	290 (N)
20	Plain, 1/4"-28 Thd.	0.13	290 (N)

Cable Shift Replacement Knob

- 1/2-13 Thd. knob for all threaded shaft Q-Series controls



Part No.	Description	Wt. (lbs.)	Cat.
B659KB	Black Replacement Knob	0.13	290 (N)

Shift Control Cable Connection Kit

- For both B-Series and Q-Series controls



Part No.	Description	Wt. (lbs.)	Cat.
BQ52105	Kit for 1/4-28 Thd. Control Cables	0.10	300 (N)
BQ62106	Kit for 5/16-24 Thd. Control Cables	0.10	300 (N)

Nut and Washer Kit for 52-Series Cable

- (4) 5/8" nuts and (4) 5/8" washers for conduit thread on 52-Series control cable



Part No.	Description	Wt. (lbs.)	Cat.
BNW015	Nut & Washer Kit for 52-Series Cable	0.29	300 (N)

Nut and Washer Kit for 62-Series Cable

- (4) 11/16" nuts and (4) 11/16" washers for conduit thread on 62-Series control cable



Part No.	Description	Wt. (lbs.)	Cat.
BNW016	Nut & Washer Kit for 62-Series Cable	0.19	300 (N)

Vinyl Coated Conduit Strap

- For larger sizes see pg. 140



375

Part No.	Description	Wt. (lbs.)	Cat.
250	For .260 Conduit	0.01	290 (N)
375	For .375 Conduit	0.01	290 (N)

Bowden Pin

- Brass construction with .098 drill thru



6170

Part No.	Description	Wt. (lbs.)	Cat.
6138	3/8" Diameter	0.03	290 (N)
6170	7/16" Diameter	0.03	290 (N)
6125B	Pivot Pin for 3/16" Thick Lever with 1/4" Hole	0.01	290 (N)

Mounting Plate

- Provides an adjustable mounting base for all output ends of clamp-type push pull cables



Part No.	Description	Wt. (lbs.)	Cat.
356	Mounting Plate	0.15	290 (N)

Universal Pivot Pin

- For 1/4" thick levers with 7/16" dia. hole
- For both 1/4"-28 Thd. and 5/16"-24 Thd.



Part No.	Description	Wt. (lbs.)	Cat.
P5262	Universal Pivot Pin	0.06	290 (N)

Throttle Stop Assembly

- Zinc-plated screw



Part No.	Description	Wt. (lbs.)	Cat.
516	5/16" Dia. Brass Barrel Throttle Stop with .088 Hole	0.02	290 (N)

Bulkhead Fitting

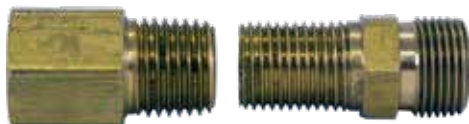

- Provides 1/2"-20 Thd. on all .375 conduit

Part No.	Description	Wt. (lbs.)	Cat.
1220R	1/2"-20 Thread Bulkhead Fitting	0.05	290 (N)

Bulkhead Fitting



- Provides 3/8"-24 Thd. on output end of all .375 conduit
- Use with VCGT, RF04D, R38D Cables

Part No.	Description	Wt. (lbs.)	Cat.
1238	3/8"-24 Thread Bulkhead Fitting	0.03	290 (N)

Bulkhead Fitting



- Provides 3/8"-24 Thd. on output end of all .260 conduit
- Use with VCGT 3100 Series Cables
- Replaces 1209R

Part No.	Description	Wt. (lbs.)	Cat.
1207R	Bulkhead Fitting, Includes Nuts & Bolts	0.09	290 (N)

Clamp



- Provides a 1/4" hole to secure output end of all .375 conduit

Part No.	Description	Wt. (lbs.)	Cat.
4100	Clamp	0.06	290 (N)

Chain Kit



- Ideal for connecting throttle controls to linkages

Part No.	Description	Wt. (lbs.)	Cat.
1250	1/4" x 6" Stainless Steel Ball Chain with 2 "S" Eyelets	0.03	290 (N)

Ball Joints & Rod End Bearings

Ball Joint

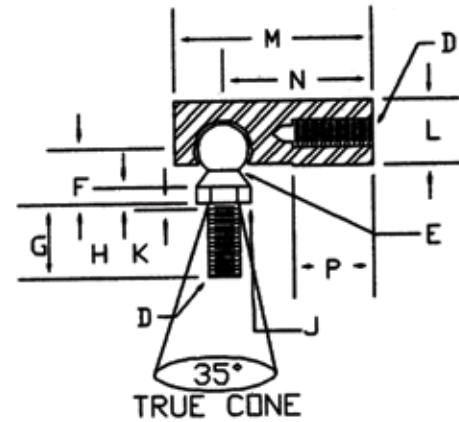

Part No.	D	E	F	G	H	J	K	L	M	N	P	Wt. (lbs.)	Cat.
BJ31	10-32	.172	7/16	7/16	1/8	5/16	1/16	3/8	1-1/16	7/8	7/16	0.13	310 (N)
BJ52	1/4-28	.193	15/32	9/16	1/8	3/8	3/32	7/16	1-7/32	31/32	1/2	0.08	310 (N)
BJ62	5/16-24	.232	17/32	11/16	5/32	7/16	3/32	1/2	1-13/32	1-1/8	9/16	0.08	310 (N)
BJ72	3/8-24	.297	11/16	7/8	3/16	1/2	3/32	5/8	1-11/16	1-3/8	3/4	0.25	310 (N)
BJ82	1/2-20	.417	7/8	11/8	1/4	5/8	1/8	3/4	2-3/8	1-15/16	1	0.31	310 (N)

Rod End Bearing

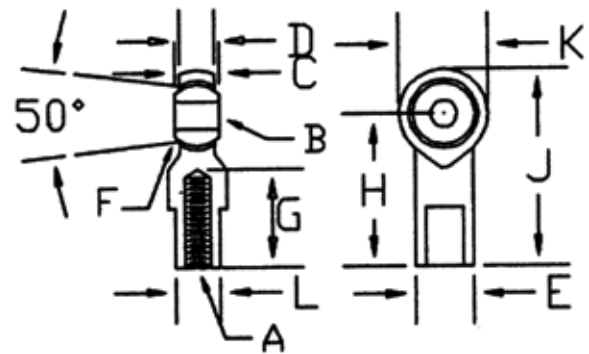

Part No.	A	B	C	D	E	F	G	H	J	K	L	M	Wt. (lbs.)	Cat.
BRE32F	10-32 UNF-2	.1895 - .1925	.310	.250	.406	.437	.562	1.062	1.375	.625	.310	.308	0.13	310 (N)
BRE52F	1/4-28 UNF-2	.2495 - .2525	.373	.281	.468	.516	.750	1.312	1.687	.750	.373	.357	0.08	310 (N)
BRE62F	5/16-24 UNF-2	.3120 - .3150	.435	.342	.500	.622	.750	1.375	1.812	.870	.435	.444	0.13	310 (N)
BRE72F	3/8-24 UNF-2	.3745 - .3775	.498	.404	.687	.716	.937	1.625	2.125	.995	.560	.514	0.13	310 (N)
BRE82F	1/2-20 UNF-2	.4995 - .5025	.623	.500	.875	.937	1.187	2.125	2.781	1.307	.748	.700	0.13	310 (N)

Rod End Bearing with Stud

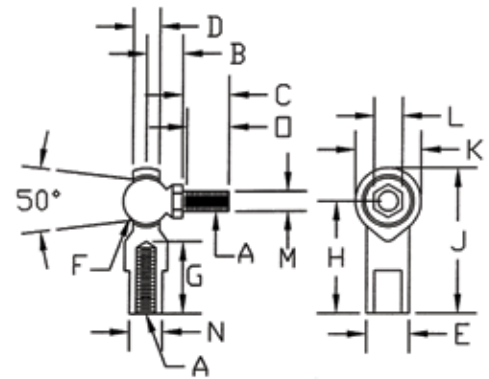

Part No.	A	B	C	D	E	F	G	H	J	K	L	M	N	O	Wt. (lbs.)	Cat.
BRE32S	10-32 UNF-2	.485	.500	.250	.406	.437	.562	1.062	1.375	.625	.310	.373	.310	.437	0.13	310 (N)
BRE52S	1/4-28 UNF-2	.485	.562	.281	.468	.516	.750	1.312	1.687	.750	.373	.435	.373	.470	0.13	310 (N)
BRE62S	5/16-24 UNF-2	.531	.687	.342	.500	.622	.750	1.375	1.812	.870	.435	.544	.435	.594	0.13	310 (N)
BRE72S	3/8-24 UNF-2	.656	.875	.404	.687	.716	.937	1.625	2.125	.995	.498	.613	.560	.781	0.18	310 (N)
BRE82S	1/2-20 UNF-2	.875	1.125	.500	.875	.937	1.187	2.125	2.781	1.307	.623	.748	.748	1.00	0.35	310 (N)

Rod End Bearing Male Thread

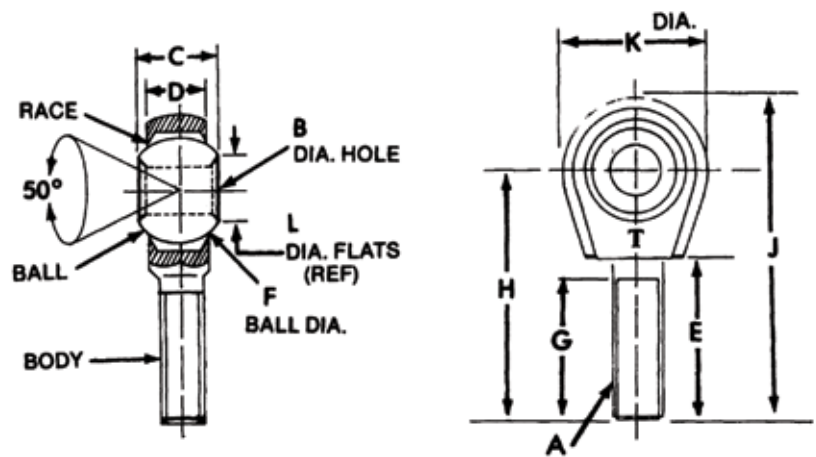

Part No.	A	B	C	D	E	F	G	H	J	K	L	Wt. (lbs.)	Cat.
BRE32M	10-32 UNF-2	.1895 - .1925	.310	.250	.812	.437	.750	1.250	1.562	.625	.308	0.03	310 (N)
BRE52M	1/4-28 UNF-2	.2495 - .2525	.373	.281	1.094	.516	1.000	1.562	1.937	.750	.357	0.06	310 (N)
BRE62M	5/16-24 UNF-2	.3120 - .3150	.435	.342	1.364	.622	1.250	1.875	2.312	.870	.444	0.06	310 (N)
BRE72M	3/8-24 UNF-2	.3745 - .3775	.498	.404	1.364	.716	1.250	1.937	2.437	.995	.514	0.10	310 (N)
BRE82M	1/2-20 UNF-2	.4995 - .5025	.623	.500	1.713	.937	1.500	2.438	3.094	1.307	.700	0.23	310 (N)

Nylon Cables Ties

Nylon Cables Ties

- 100% nylon
- Bent tip for ease of installation
- Available in natural or black weather resistant (WR)

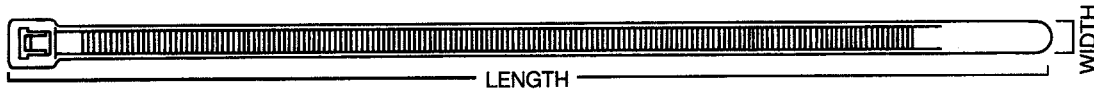

Part No.	Length	Width	Tensile Strength (lbs.)	Color	Military Standard	Package Quantity	Package Wt. (lbs.)	Cat.
BTN055CPK	5-1/2"	.180	50	Natural	MS-3367-5	100 PC	0.08	320 (Y)
BTN075	7-1/2"	.180	50	Natural	MS-3367-1	1000 PC	2.50	320 (Y)
BTN075CPK	7-1/2"	.180	120	Natural	MS-3367-1	100 PC	0.13	320 (Y)
BTN011CPK	11"	.180	50	Natural	MS-3367-7	100 PC	0.18	320 (Y)
BTN011	11"	.180	50	Natural	MS-3367-7	500 PC	4.25	320 (Y)
BTN145	14-1/2"	.250	120	Natural	MS-3367-3	100 PC	0.98	320 (Y)
BTN015	15"	.180	50	Natural	MS-3367-2	100 PC	0.57	320 (Y)
BTN240	24"	.350	175	Natural	N/A	50 PC	1.40	320 (Y)
BTN300	30"	.350	175	Natural	MS-3367-6	50 PC	2.08	320 (Y)
BTN075WRCPK	7-1/2"	.180	50	Black	MS-3367-1	100 PC	0.26	320 (Y)
BTN075WR	7-1/2"	.180	50	Black	MS-3367-1	1000 PC	2.60	320 (Y)
BTN011WRCPK	11"	.180	50	Black	MS-3367-7	100 PC	0.24	320 (Y)
BTN011WR	11"	.180	50	Black	MS-3367-7	500 PC	1.96	320 (Y)
BTN145WR	14-1/2"	.250	120	Black	MS-3367-3	100 PC	0.98	320 (Y)
BTN015WR	15"	.180	50	Black	MS-3367-2	100 PC	0.56	320 (Y)

Adhesive Mount



- 1" square adhesive mount
- Also accepts #6 screw
- For all ties up to .180 wide
- 100 pcs. per bag
- Color: Natural

Part No.	Description	Wt. (lbs.)	Cat.
B08462	Adhesive Mount	0.42	320 (Y)

PTO DRIVELINE

All the universal joints, assemblies and accessories you need to keep your trucks working.

UNIVERSAL JOINT ASSEMBLIES	L2
SOLID SHAFTING AND SHAFT ADAPTERS	L4
YOKES	L5
SHAFT ASSEMBLIES	L6
SPLINED STUB INSERTS, KEY STOCK & SET SCREWS	L9
U-JOINTS/JOURNAL ASSEMBLIES/CROSSES	L10
GREASE FITTINGS	L11
BEARINGS	L12

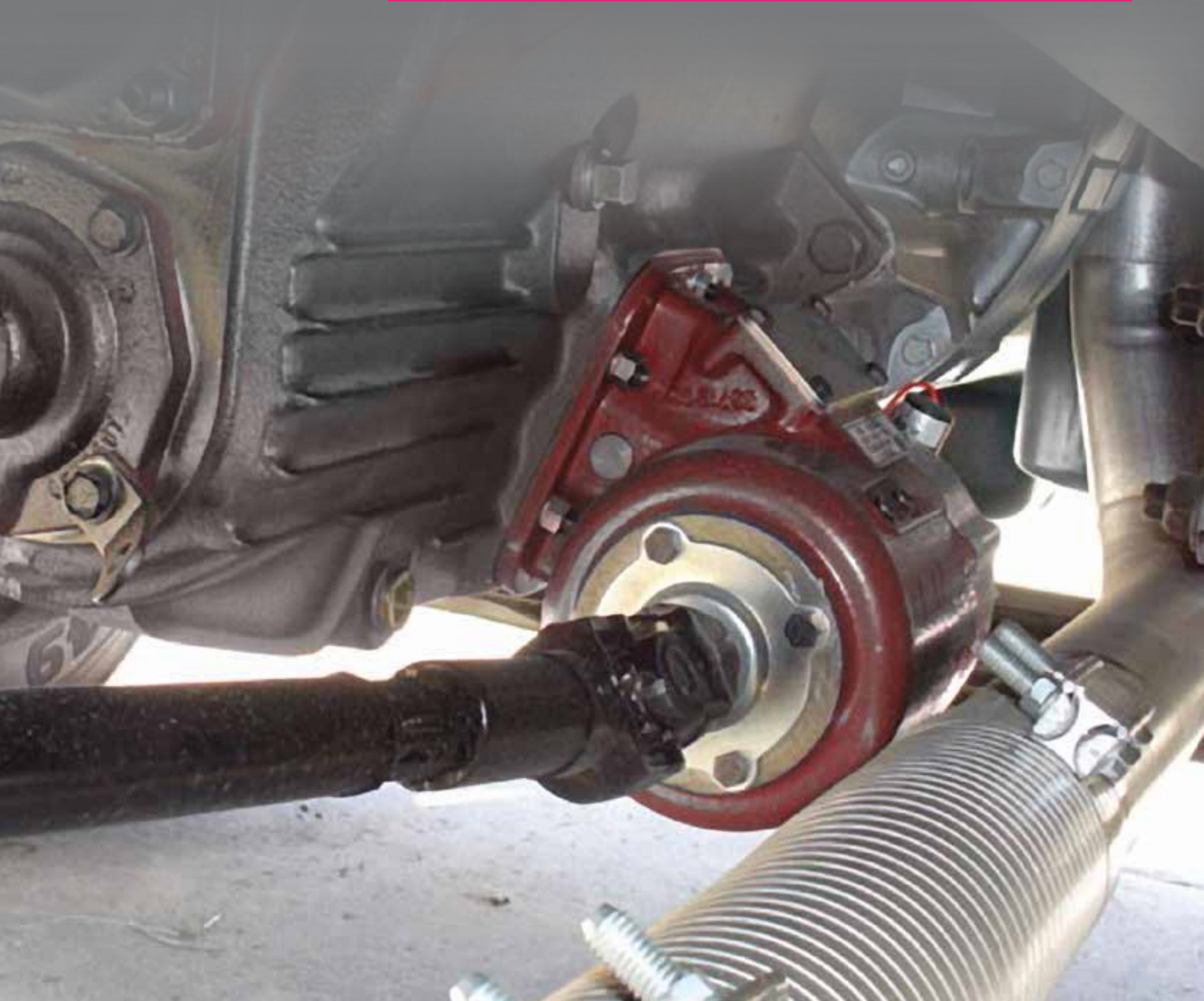

Universal Joint Assemblies, End Yokes

H7 Series Universal Joint Assemblies

- Maximum recommended torque (continuous duty 1000 RPM): needle bearing - 800 inch pounds
- Maximum recommended angle of operation 15° continuous duty
- Interchangeable with other major manufacturers.



2.5000 CLEARANCE DIA.



H7 Standard Length



H7 Slip Length

Ordering Pre-Assembled Universal Joint Assemblies

Contact customer service to order pre-assembled joint assemblies.

Build The Assembly Part Number:

1. End Yoke Part Number
2. Choose Length: Standard (010) or Slip (020)
- 3.* End Yoke or Slip Yoke Part Number

*In Ordering Slip Joints- Step 3 will be a Slip yoke size.

Example:

Standard Joint Assembly- 74230107413
Slip Joint Assembly - 742302073133

H7 Series End Yoke

- H7-Series needle bearing uses NB7A "U" joint

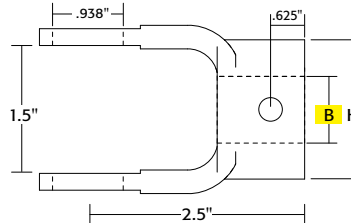

Part No.	Bore Size	Keyway Size	Keyway AT	Set Screw Size	Set Screw AT	H	Cat.
Round Bore at B							
74373	5/8"	3/16"	1	3/8"-16	4	15/8"	020 (Y)
7413	3/4"	3/16"	1	3/8"-16	4	15/8"	020 (Y)
7423	3/4"	1/4"	1	3/8"-16	4	15/8"	020 (Y)
7443	13/16"	1/4"	1	3/8"-16	4	15/8"	020 (Y)
7453	7/8"	3/16"	1	3/8"-16	4	15/8"	020 (Y)
74263	7/8"	1/4"	1	3/8"-16	4	15/8"	020 (Y)
7463	7/8"	1/4"	2	3/8"-16	4	15/8"	020 (Y)
74293	1"	1/4"	1	3/8"-16	4	2"	020 (Y)
7493	1"	1/4"	2	3/8"-16	4	2"	020 (Y)
74393	1"	1/4"	2	3/8"-16	1	2"	020 (Y)
74443	1"	-	-	3/8" Pin hole	-	2"	020 (Y)
74103	1-1/8"	1/4"	2	3/8"-16	4	2"	020 (Y)
74183	1-1/4"	1/4"	2	3/8"-16	4	2"	020 (Y)
74123	1-1/4"	5/16"	2	3/8"-16	1	2"	020 (Y)
74223	1-1/4"	5/16"	2	3/8"-16 (2)	1-4	2"	020 (Y)
74323	1-1/4"	WELD	-	-	-	2"	020 (Y)
Square Bore at B							
7422	3/4"	-	Square	3/8"-16	4	15/8"	020 (Y)
7412	7/8"	-	Square	3/8"-16	4	2"	020 (Y)
7452	1"	-	Square	3/8"-16	4	2"	020 (Y)
Hex Bore at B							
74282	7/8"	-	Hex	3/8"-16	4	2"	020 (Y)
7432	1-1/8"	-	Hex	3/8"-16	4	2"	020 (Y)
Spline Bore at B							
74481	7/8"-13 SP.	Spline	3/8"-16	3	-	2"	020 (Y)
Quick Detach Bore							
74141	1-3/8"-6 SP.	Spline	O.D.	-	-	2"	020 (Y)

*Weld Type Yoke for Telescoping Driveline

H7 Series Slip Yokes

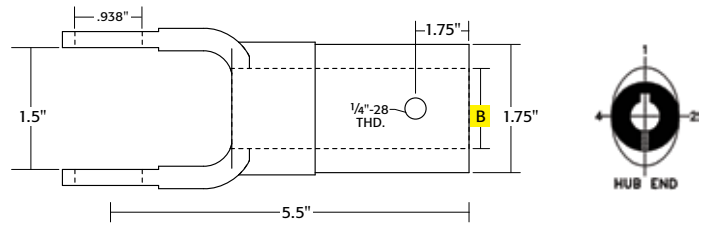

- H7-Series needle bearing uses NB7A "U" joint

Part No.	Bore Size	Keyway Size	Keyway AT	Lubricator AT	Cat.
Round Bore at B					
73133	7/8"	1/4"	1	2	020 (Y)
73383	1"	1/4"	1	2	020 (Y)
7383	1"	1/4"	2	4	020 (Y)
73163	1-1/4"	5/16"	2	4	020 (Y)
Square Bore at B					
7312	3/4"	-	-	3	020 (Y)
7322	7/8"	-	-	3	020 (Y)
73122	1"	-	-	3	020 (Y)
Hex Bore at B					
73162	7/8"	-	-	3	020 (Y)
7332	1-1/8"	-	-	3	020 (Y)
Spline Bore at B					
7381	1-1/8"-10 SP.	-	-	3	020 (Y)
7351	1-1/4"-6 SP.	-	-	3	020 (Y)

Tubular Shaft Assemblies TSA7 Series

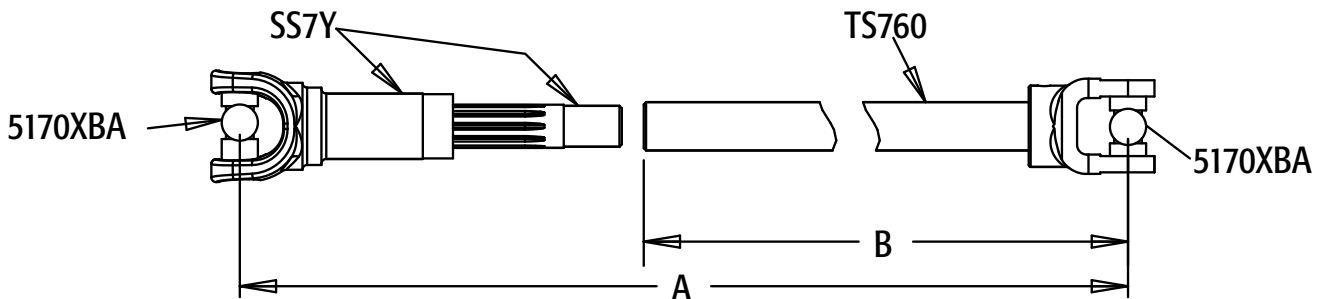

Part No.	Journal Assembly	Yoke & Stub 1-1/8"-10 Spline Kit	Tube & Weld Yoke	Overall Length	A	B Tube & Weld Yoke	Wt. (lbs.)	Cat.
TSA760	5170XBA	SS7Y (Yoke# 7381; Stub# SS)	TS760	60"	55"	46-1/2"	12.16	040 (Y)
TSA772	5170XBA	SS7Y (Yoke# 7381; Stub# SS)	TS772	72"	67"	58-1/2"	11.20	040 (Y)

TSA7 with Midship Stub

- MSS Stubshaft use with TS760 and TS772 yoke and tubes, KAN Woodruff Key, P16 Pillow Block and H7EY1R1/4KW

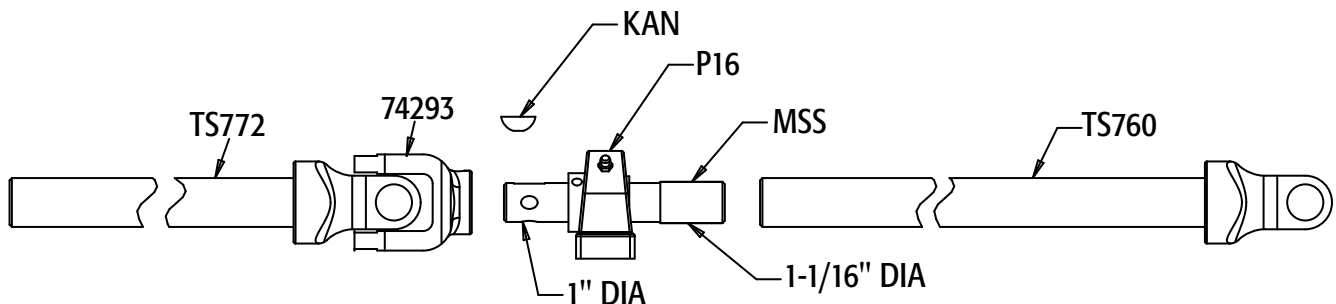

Solid Shafting, Adapters, Pin and Block Joints

Solid Shafting

- Buyers solid shafting speeds up P.T.O. installation while the full length keyway eliminates waste and increases strength
- All solid shafting is produced with driveline shafting grade steel
- Available with round, splined, square, and hex shaftings



Part No.	Diameter	Keyway	Length	Wt. (lbs.)	Cat.
Round Shafting					
10025372	1"	1/4"	72"	16.02	110 (Y)
12531372	1-1/4"	5/16"	72"	25.02	110 (Y)
15037372	1-1/2"	3/8"	72"	36.00	110 (Y)
Splined Shafting					
SH2027	1-1/4" 6 Splined	5/16"	72"	23.76	110 (Y)
Hex Shafting					
871272	7/8" Hex	-	72"	13.50	110 (Y)
1121272	1-1/8" Hex	-	72"	22.38	110 (Y)

Shaft Adapters

- Designed for tractor trailer drivelines, the 1-3/8"-6 spline is grooved to accommodate quick detach button types

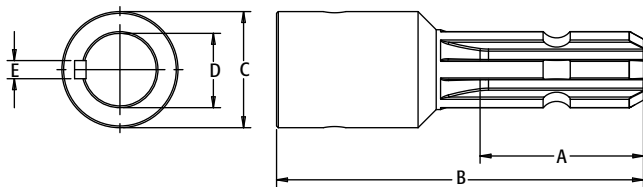

Part No.	A	B	C	D	E
SA1	3.00	6.32	2.00	1.00	1/4"
SA2	3.00	6.32	2.00	1.125	1/4"
SA3	3.00	6.32	2.00	1.25	5/16"
SA4	3.00	7.13	2.75	1.50	3/8"

H3 Standard Pin & Block Joints

- Ideal for tarp systems
- Max rating 400 lbs @1000rpm
- 15° Max operation angle

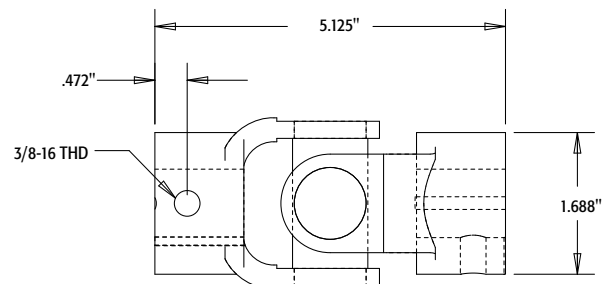

Part No.	Sizes Stocked
H3393X393	1R-1/4KW x 1" Round 1/4KW
H3293X282	1R-1/4KW x 7/8" Hex
H3013X013	3/4R-3/16KW x 3/4-3/16KW

B1310 Series Joint Assemblies

- Compatible with other major manufacturers' driveline components
- Perfect for heavy-duty applications - up to 1560 inch pounds of torque at 1000 RPM continuous duty
- Variety of sizes and bore types available
- Allows for smooth and continuous torque transfer when used with Buyers Products 5153XBA U-joints
- Gives you the ability to disassemble a drive shaft where space is tight

B1310 Series End Yokes

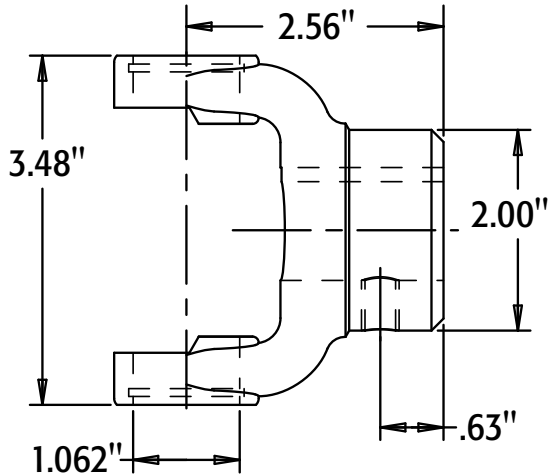

Part No.	Description	Wt. (lbs.)	Cat.
B24473	1" Round, 1/4" KW	1.80	020 (Y)
B24503	1-1/8" Round, 1/4" KW	1.66	020 (Y)
B24533	1-1/4" Round, 5/16" KW	1.73	020 (Y)
B24573	1-1/4" Round, 1/4" KW	1.73	020 (Y)
B241103	1-1/4" Round, No Keyway No Setscrew	1.76	020 (Y)
B243331	7/8" 13 Spline Bore	2.00	020 (Y)
B2432	1-1/8" Hex Bore	2.40	020 (Y)

B1310 Series Slip Yokes

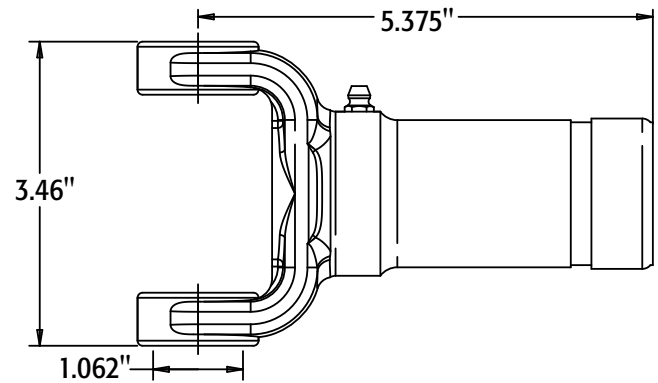

Part No.	Description	Wt. (lbs.)	Cat.
B23128KX	1-3/8" 16 Spline Bore	2.32	020 (Y)
B23130	1-1/8" 10 Spline Bore	1.91	020 (Y)
11840H	1-1/8" Hex Bore	1.91	020 (Y)

B1310 Series Flange Yokes

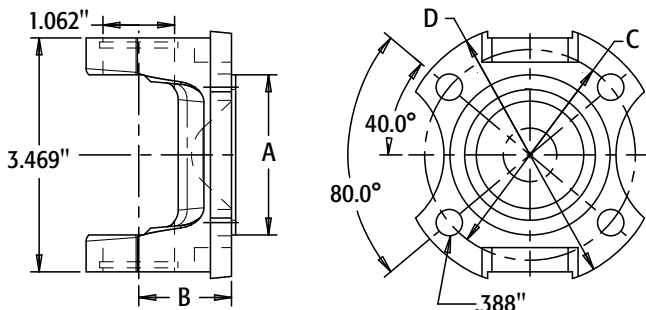

Part No.	A	B	C	D	Wt. (lbs.)	Cat.
B22329	2.375	1.375	3.125	3.875	1.50	020 (Y)
B22479	2.750	1.375	3.750	4.625	2.00	020 (Y)

B1310 Series Companion Flange

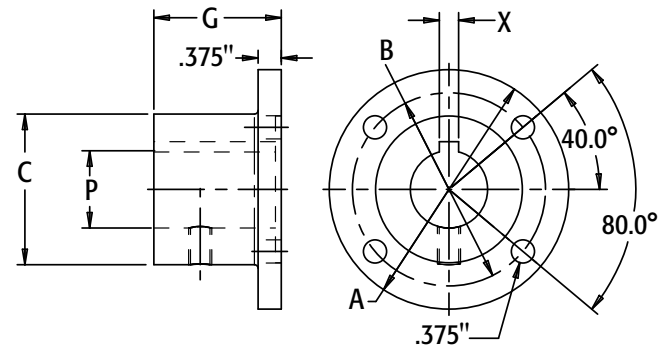

Part No.	A	B	C	G	P	X	Wt. (lbs.)	Cat.
B21333	3.875	3.125	2.44	2	1.25	.3125	23	020 (Y)

Driveshaft Assemblies

B1310 Tubular Shaft Assembly

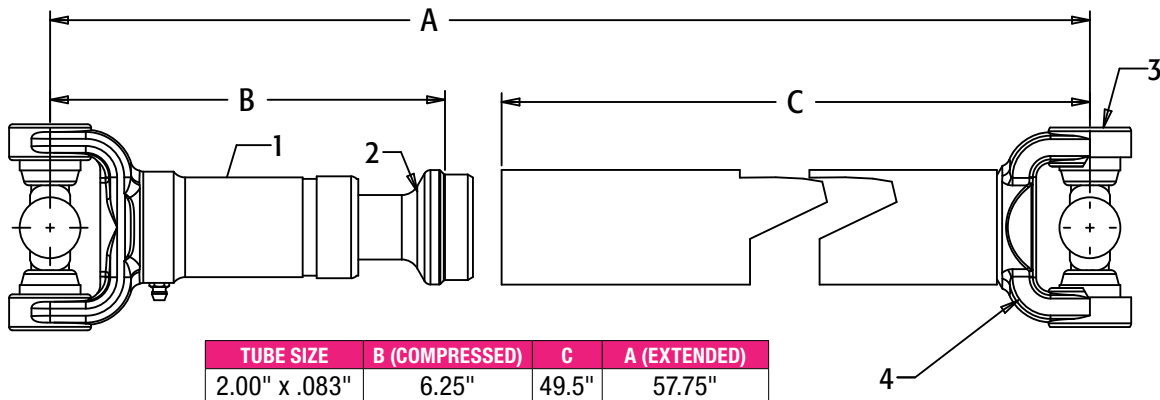

Part No.	Description	Wt. (lbs.)	Cat.
B9553SF	B1310 Tubular Shaft Assembly	15.0	020 (Y)
B23128KX ①	Slip Yoke, 1-3/8"-16 Spline	2.32	020 (Y)
B2401031 ②	Stub Shaft, 1-3/8"-16 Spline	2.25	020 (Y)
5153XBA ③	Cross Bearing	1.17	020 (Y)
B228357TY ④	Tube and Yoke	9.26	020 (Y)

B1310 Midship Stub Shaft

- Stub is used with a P20 pillow block, KBN Woodruff Key and B24533 end yoke

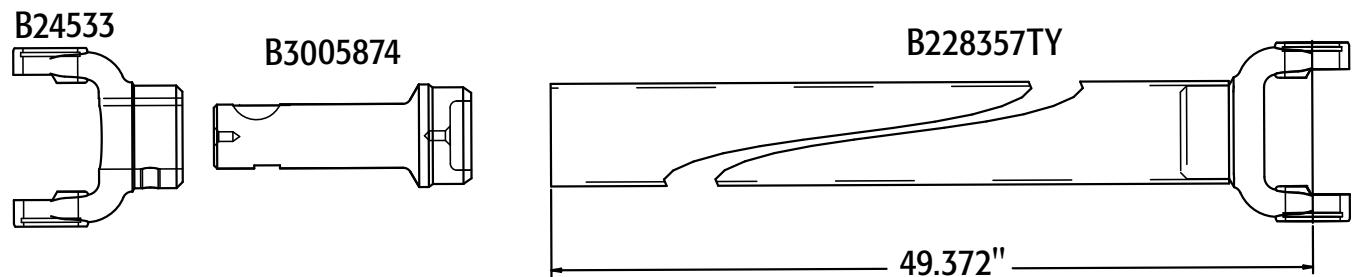

Part No.	Description	Wt. (lbs.)	Cat.
B3005874	B1310 Midship Stub Shaft	2.05	020 (Y)

B1310 Solid Shaft Assembly

- Solid Shaft Assembly is used for close coupled applications

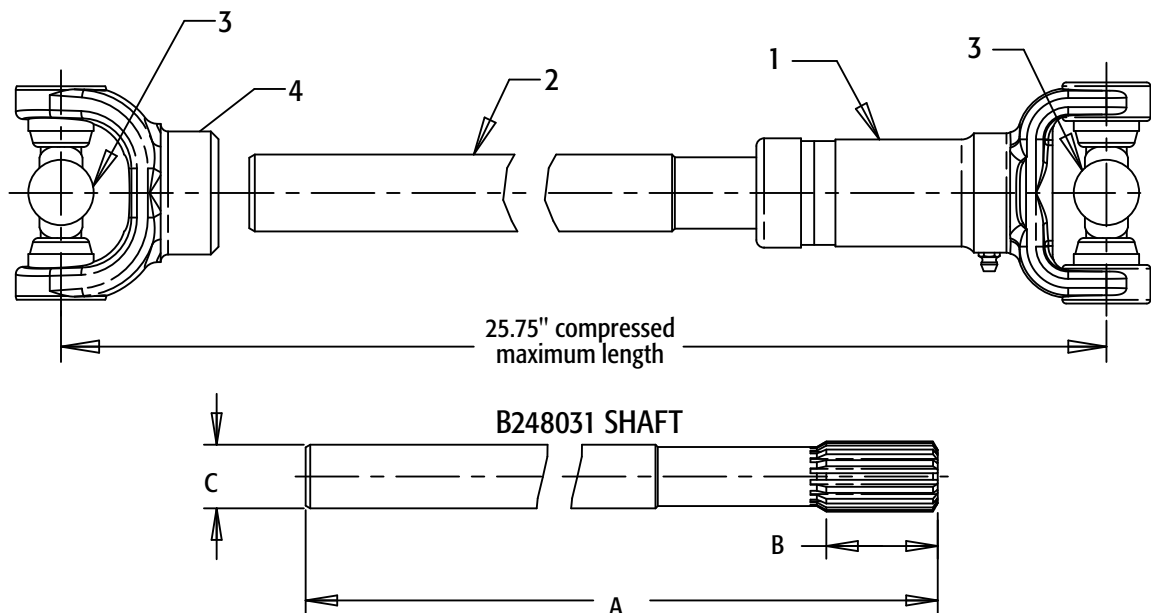

A	B	C
24"	1-3/8" - 16 Spline	1-1/4"

Part No.	Description	Wt. (lbs.)	Cat.
B91382SF	B1310 Solid Shaft Assembly	13.56	020 (Y)
B23128KX ①	Slip Yoke, 1-3/8"-16 Spline	2.32	020 (Y)
B248031 ②	Solid Shaft	8.31	020 (Y)
5153XBA ③	Cross Kit	1.17	020 (Y)
B241103 ④	Weld Yoke	1.76	020 (Y)

B1310 1-1/8" Hex Solid Shaft Driveline

- No welding required

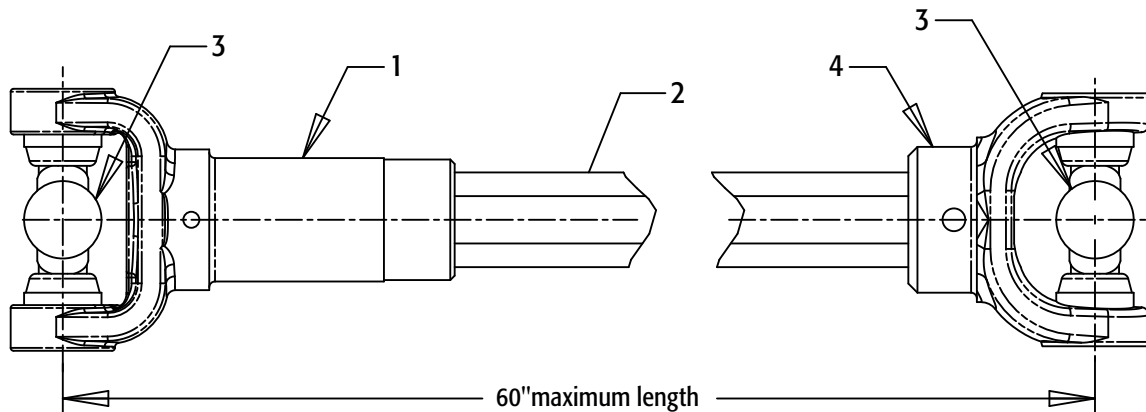

Part No.	Description	Wt. (lbs.)	Cat.
B91322SF	B1310 1-1/8" Hex Solid Shaft Driveline	27.65	020 (Y)
11840H ①	Slip Yoke, 1-1/8" Hex Slip Yoke	1.70	020 (Y)
1121272 ②	1-1/8" Hex Shaft	22.38	020 (Y)
5153XBA ③	Cross Kit	1.17	020 (Y)
B2432 ④	1-1/8" Hex End Yoke	2.4	020 (Y)

Tubular Shaft Assemblies

Tubular Shaft Assemblies TSA13 Series

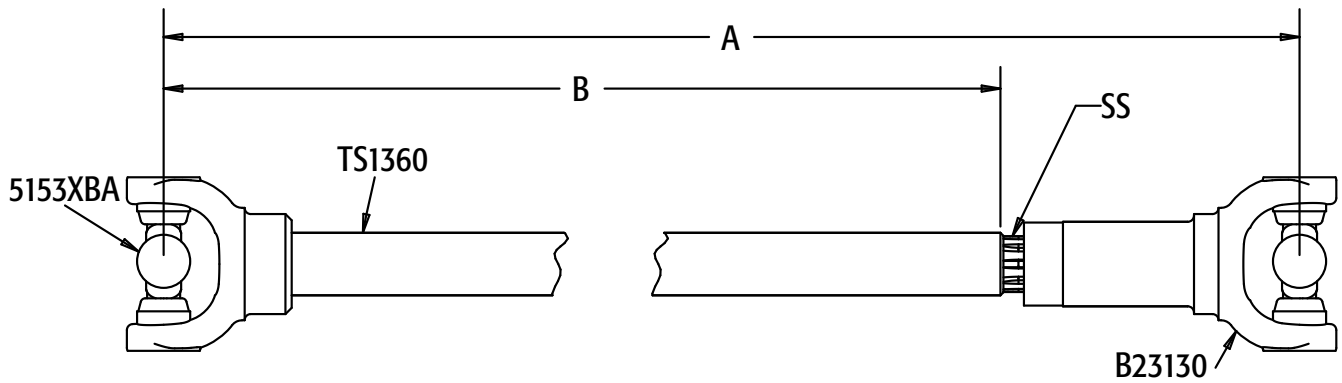

Part No.	Journal Assembly	Slip Yoke	Stub Shaft	Tube & Weld Yoke	Overall Length	A	B Tube & Weld Yoke	Wt. (lbs.)	Cat.
TSA1360	5153XBA	B23130 1-1/8-10 SP	SS	TS1360	60"	55"	46-1/2"	13.29	040 (Y)
TSA1372	5153XBA	B23130 1-1/8-10 SP	SS	TS1372	72"	67"	58-1/2"	14.75	040 (Y)

TSA13 with Midship Stub

- MSS stub shaft use with TS1360 and TS1372 yoke and tubes, KAN Woodruff Key, P16 pillow block and B24473 1"R end yoke

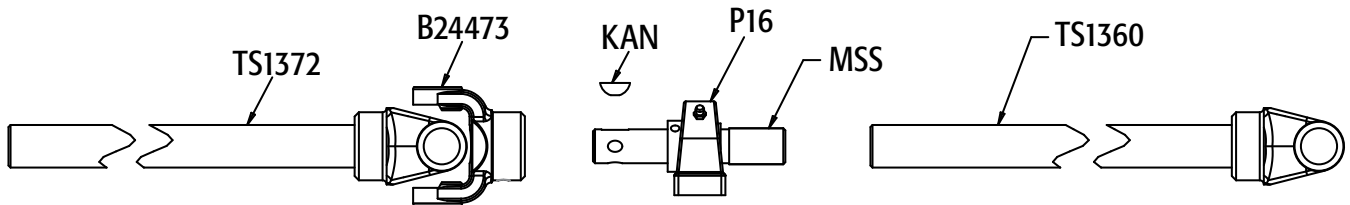

Solid Splined Stub Insert

- 1-1/8" 10 splined stub shaft for use with 1-1/4" dia. tubing with .095 wall



Part No.	Description	Wt. (lbs.)	Cat.
SS	Solid Splined Stub	1.50	060 (N)

Step Keys



Part No.	Description	Wt. (lbs.)	Cat.
KS4512	1/4" x 5/16" x 12"	0.25	070 (N)
KS5612	5/16" x 3/8" x 12"	0.35	070 (N)

Square Keys/Key Stock



Part No.	Description	Wt. (lbs.)	Cat.
KS302	3/16" Sq. Key x 2" Long	0.13	070 (N)
KS402	1/4" Sq. Key x 2" Long	0.13	070 (N)
KS404	1/4" Sq. Key x 4" Long	0.13	070 (N)
KS502	5/16" Sq. Key x 2" Long	0.13	070 (N)
KS504	5/16" Sq. Key x 4" Long	0.13	070 (N)
KS602	3/8" Sq. Key x 2" Long	0.13	070 (N)
KS312	3/16" Sq. x 12" Long	0.13	070 (N)
KS412	1/4" Sq. x 12" Long	0.25	070 (N)
KS512	5/16" Sq. x 12" Long	0.38	070 (N)
KS612	3/8" Sq. x 12" Long	0.50	070 (N)

Woodruff Keys



Part No.	Description	Wt. (lbs.)	Cat.
K5N	1/8" x 5/8"	0.01	070 (N)
K15N	1/4" x 1"	0.02	070 (N)
K18N	1/4" x 1-1/8"	0.03	070 (N)
K24N	1/4" x 1-1/2"	0.05	070 (N)
KAN	1/4" x 7/8"	0.02	070 (N)
KBN	5/16" x 1"	0.03	070 (N)
KCN	5/16" x 1-1/8"	0.04	070 (N)

Square Head Set Screw Cap Point

- Sold in multiples of 100



Part No.	Description	Wt. (lbs.)	Cat.
34	3/8"-16 Thd. x 3/4" (3/32" Dia. Hole)	0.03	080 (N)
14	1/4"-20 x 3/4" NC (No Hole)	0.01	080 (N)

Allen Head Set Screws

- Sold in multiples of 100



Part No.	Description	Wt. (lbs.)	Cat.
32	3/8"-16 Thd. x 1/2"	0.01	080 (N)
38	3/8"-16 Thd. x 3/8"	0.01	080 (N)

Journal Assemblies, Fittings

Journal Assembly



Part No.	Description	Cap Diameter	Clip Style	Wt. (lbs.)	Cat.
NB7A	H7 Series U-Joint	15/16"	Inside Lock	0.50	030 (Y)
NB12A	H7 Series U-Joint	1-1/16"	Inside Lock	0.83	030 (Y)
5153XBA	B1310 Series U-Joint	1-1/16"	Outside Lock	1.17	030 (Y)
5170XBA	B1310 Series U-Joint			0.50	030 (Y)

Drive-in Grease Fittings

- Sold in multiples of 100



Part No.	Hole Size	Overall Size	Ball Check	Angle	Wt. (lbs.)	Cat.
500	5/16"	5/8"	–	Straight	0.01	090 (N)
511	3/16"	5/8"	–	Straight	0.01	090 (N)
515	1/4"	5/8"	–	Straight	0.01	090 (N)

NPT Thread Grease Fittings

- Sold in multiples of 100



Part No.	Thread Size	Overall Size	Ball Check	Angle	Wt. (lbs.)	Cat.
800	1/8" NPT	49/64"	Yes	Straight	0.01	090 (N)
815	1/8" NPT	1-1/4"	Yes	Straight	0.03	090 (N)
851	1/8" NPT	7/8"	Yes	45°	0.02	090 (N)
852	1/8" NPT	29/32"	Yes	67-1/2°	0.02	090 (N)
853	1/8" NPT	7/8"	Yes	90°	0.02	090 (N)
900	1/4" NPT	1/4"	Yes	Straight	0.03	090 (N)

1/4"-28 Taper Thread Grease Fittings

- Sold in multiples of 100



Part No.	Thread Size	Overall Size	Ball Check	Angle	Wt. (lbs.)	Cat.
400	1/4"-28	39/64"	Short	Straight	0.01	090 (N)
450	1/4"-28	29/32"	Short	45°	0.02	090 (N)
455	1/4"-28	5/16"	Short	90°	0.02	090 (N)

Grease Fitting Assortment

- Contains: (25) 400, (10) 450, (10) 455, (10) 511, (20) 800, (10) 851, (5) 852, (10) 853



Part No.	Hole Size	Overall Size	Ball Check	Angle	Wt. (lbs.)	Cat.
1148	Grease Fitting Assortment, 100 Pieces. Packaged in a Durable Labeled Box				1.49	090 (N)

Precision Ground Pillow Blocks

Precision Ground Pillow Block - Eccentric Locking Collar Style

- Self-aligning, replaceable bearings are produced with eccentric locking collars which allow for higher RPM & provide longer life

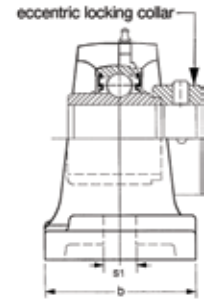
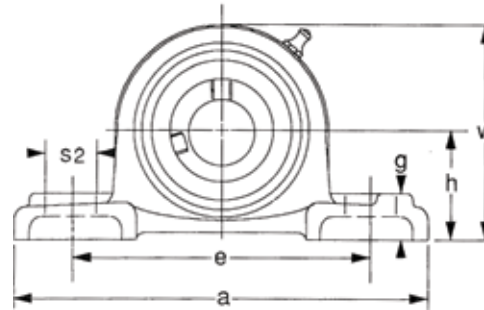

Part No.	Bearing Only Part No.	Shaft Dia	H	A	E	B	S1	S2	G	W	Bolt Used	Wt. (lbs.)	Cat.
P12	-	3/4"	1-5/16"	5"	3-3/4"	1-1/2"	1/2"	3/4"	19/32"	2-31/64"	3/8"	1.15	390 (Y)
P14	AR014	7/8"	1-7/16"	5-1/2"	4-1/8"	1-1/2"	1/2"	3/4"	19/32"	2-25/32"	3/8"	1.90	390 (Y)
P15	AR015	15/16"	1-7/16"	5-1/2"	4-1/8"	1-1/2"	1/2"	3/4"	19/32"	2-25/32"	3/8"	1.90	390 (Y)
P16	-	1"	1-7/16"	5-1/2"	4-1/8"	1-1/2"	1/2"	3/4"	19/32"	2-25/32"	3/8"	1.90	390 (Y)
P18	-	1-1/8"	1-11/16"	6-1/2"	4-3/4"	1-7/8"	21/32"	13/16"	11/16"	3-5/16"	1/2"	3.25	390 (Y)
P20	-	1-1/4"	1-7/8"	6-9/16"	5"	1-7/8"	21/32"	13/16"	3/4"	3-21/32"	1/2"	4.10	390 (Y)
P24	-	1-1/2"	1-15/16"	7-1/4"	5-13/32"	2-1/8"	21/32"	13/16"	25/32"	3-27/32"	1/2"	4.75	390 (Y)

Precision Ground Pillow Block - Set Screw Style

- Self-aligning, replaceable bearing, with extended inner race, set screw locking

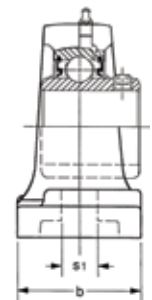
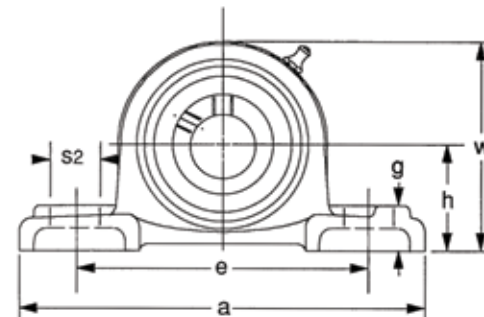

Part No.	Shaft Dia	H	A	E	B	S1	S2	G	W	Bolt Used	Wt. (lbs.)	Cat.
P12SCR	3/4"	1-5/16"	5"	3-3/4"	1-1/2"	1/2"	3/4"	5/8"	2-31/64"	3/8"	1.6	390 (Y)
P16SCR	1"	1-7/16"	5-1/2"	4-1/8"	1-1/2"	1/2"	3/4"	5/8"	2-25/32"	3/8"	1.9	390 (Y)
P18SCR	1-1/8"	1-11/16"	6-1/2"	4-3/4"	1-7/8"	21/32"	13/16"	23/32"	3-5/16"	1/2"	3.4	390 (Y)
P20SCR	1-1/4"	1-11/16"	6-1/2"	4-3/4"	1-7/8"	21/32"	13/16"	23/32"	3-5/16"	1/2"	3.3	390 (Y)
P22SCR	1-3/8"	1-7/8"	6-9/16"	5"	1-7/8"	21/32"	13/16"	23/32"	3-21/32"	1/2"	4.0	390 (Y)
P24SCR	1-1/2"	1-15/16"	7-1/4"	5-13/32"	2-1/8"	21/32"	13/16"	25/32"	3-27/32"	1/2"	5.0	390 (Y)
P28SCR	1-3/4"	2-1/8"	7-15/32"	5-3/4"	2-1/8"	21/32"	13/16"	55/64"	4-3/16"	1/2"	5.6	390 (Y)
P30SCR	1-15/16"	2-1/4"	8-1/8"	6-1/4"	2-3/8"	25/32"	7/8"	7/8"	4-7/16"	5/8"	7.0	390 (Y)
P32SCR	2"	2-1/2"	8-5/8"	6-23/32"	2-3/8"	25/32"	7/8"	61/64"	4-29/32"	5/8"	8.5	390 (Y)
P18HEX	1-1/8 Hex	1-7/8"	6-9/16"	5"	1-7/8"	21/32"	13/16"	3/4"	3-21/32"	1/2"	3.65	390 (Y)

Spreader and Jackshaft Bearing

- Cast iron housing for use on spreaders, wreckers & similar type applications

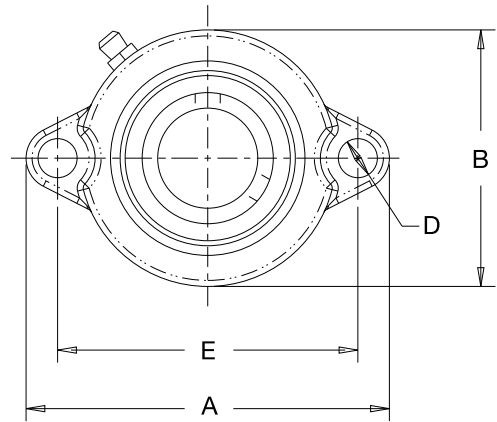

Part No.	Description	Bore	A	B	C	D	Wt. (lbs.)	Cat.
2FS16	2 Hole Mount Bearing	1"	3-3/4"	3"	2-25/32"	25/64"	0.9	390 (Y)

Heavy-Duty, Adjustable Bronze Bearing Hanger Assy.

- Self-aligning
- #EJ replacement bearing only
- Specify size (i.e. E16J)



Part No.	Description	Wt. (lbs.)	Cat.
DKE14JSQ	7/8" Square	2.50	440 (Y)

Bronze Bearing Pillow Block

- Self-aligning



Part No.	Description	Overall Height	Overall Width	Bolt Hole Center to Center	Wt. (lbs.)	Cat.
BFE12G	3/4" Pillow Block	2.25	4.63	3.375	0.70	390 (Y)
BFE16G	1" Pillow Block	2.25	4.63	3.375	0.70	390 (Y)
BFE20G	1-1/4" Pillow Block	2.25	4.63	3.375	0.70	390 (Y)

Fittings and Flange Units

2 Hole Eccentric Locking Collar Style or Set Screw Flange Units

- These quality flange units are produced with self-aligning replaceable bearings and an eccentric locking collar

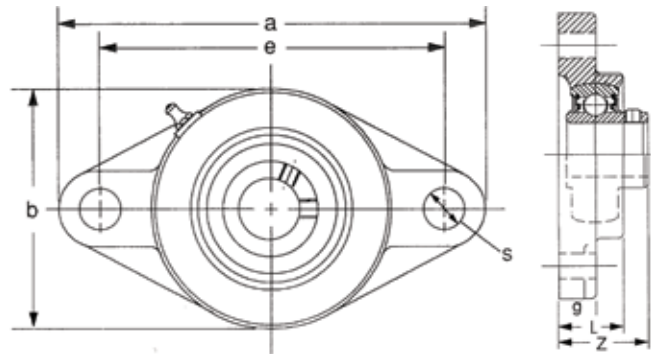

PART NO.	SHAFT DIA.	A	E	G	L	S	B	Z	BOLT USED	Wt. (lbs.)	Cat.
LOCK COLLAR STYLE											
2F12	3/4"	4-13/32"	3-17/32"	7/16"	1-5/32"	13/32"	2-3/8"	1-25/32"	3/8"	1.20	390 (Y)
2F16	1"	4-7/8"	3-57/64"	17/32"	1-7/32"	1/2"	2-3/4"	1-27/32"	3/8"	2.00	390 (Y)
2F20	1-1/4"	6-1/8"	5-1/8"	9/16"	1-7/16"	35/64"	3-3/4"	2-1/8"	7/16"	3.40	390 (Y)
SET SCREW STYLE											
2F12SCR	3/4"	4-7/16"	3-35/64"	7/16"	1"	15/32"	2-3/8"	15/16"	3/8"	1.20	390 (Y)
2F16SCR	1"	5-1/8"	3-57/64"	1/2"	1-1/16"	5/8"	2-11/16"	1-13/32"	1/2"	1.40	390 (Y)
2F18SCR	1-1/8"	5-13/16"	4-39/64"	1/2"	1-7/32"	5/8"	3-5/32"	1-19/32"	1/2"	2.00	390 (Y)
2F20SCR	1-1/4"	5-13/16"	4-39/64"	1/2"	1-7/32"	5/8"	3-5/32"	1-19/32"	1/2"	2.00	390 (Y)
2F24SCR	1-1/2"	6-7/8"	5-43/64"	9/16"	1-13/32"	5/8"	3-15/16"	2-1/32"	1/2"	3.50	390 (Y)

4 Hole Eccentric Locking Collar Style or Set Screw Flange Units

- These quality flange units are produced with self-aligning replaceable bearings and an eccentric locking collar

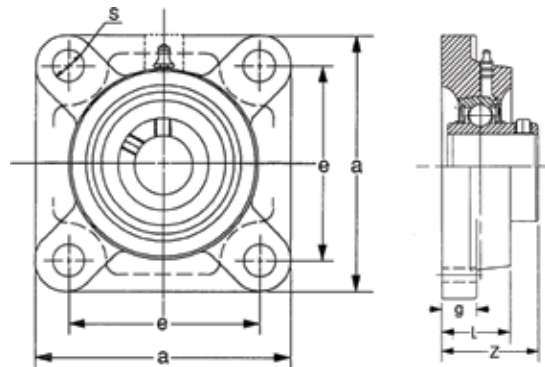

PART NO.	SHAFT DIA.	A	E	G	L	S	Z	BOLT USED	Wt. (lbs.)	Cat.
LOCK COLLAR STYLE										
4F16	1"	3-3/4"	2-3/4"	7/16"	1-3/8"	29/64"	1-57/64"	3/8"	2.15	390 (Y)
4F20	1-1/4"	4-5/8"	3-5/8"	1/2"	1-1/2"	33/64"	2-5/32"	7/16"	4.00	390 (Y)
4F24	1-1/2"	5-1/8"	4"	5/8"	1-5/8"	35/64"	2-11/32"	1/2"	4.75	390 (Y)
SET SCREW STYLE										
4F12SCR	3/4"	3-3/8"	2-33/64"	15/32"	1"	15/32"	1-5/16"	3/8"	1.40 lbs.	390 (Y)
4F16SCR	1"	3-3/4"	2-3/4"	9/16"	11/16"	15/32"	1-13/32"	3/8"	1.80 lbs.	390 (Y)
4F20SCR	1-1/4"	4-1/4"	3-17/64"	9/16"	17/32"	15/32"	1-19/32"	3/8"	2.40 lbs.	390 (Y)
4F24SCR	1-1/2"	5-1/8"	4-1/64"	5/8"	1-13/32"	5/8"	2-1/32"	1/2"	4.20 lbs.	390 (Y)
4F28SCR	1-3/4"	5-13/32"	4-9/64"	23/32"	1-1/2"	5/8"	2-1/16"	1/2"	5.10 lbs.	390 (Y)
4F30SCR	1-15/16"	5-5/8"	4-3/8"	23/32"	1-9/16"	5/8"	2-5/32"	1/2"	5.80 lbs.	390 (Y)
4F32SCR	2"	6-3/8"	5-1/8"	25/32"	1-11/16"	3/4"	2-5/16"	5/8"	7.50 lbs.	390 (Y)

AISI: American Iron and Steel Institute

BHN: Brinell Hardness Number - commonly used to define the hardness of materials like metals and alloys by measuring the force needed to cause an indentation.

CA13 rating: specifies minimum brightness for amber colored lights

DOT: Department of Transportation - the agency dealing with regulations concerning both the manufacture and operation of motor vehicles and equipment

FMVSS 108: Federal Motor Vehicle Safety Standard regulating all type, location, and performance requirements for automotive lighting, signaling and reflective devices

FMVSS 571.106: DOT specs for air push lock fittings on mobile applications

FSD: Full scale deflection

GPM: Gallons per minute

HDPE: High Density Polyethylene

HG: Inches of Mercury - vacuum

HRPO: Hot rolled, Pickled and oiled pertaining to steel treatment

ICC: Interstate Commerce Commission - the former federal agency that regulated requirements for motor carriers

JIC: Joint Industry Committee - the organization set up to standardize hydraulic fitting specifications and symbols

LED: Light Emitting Diode – two-lead semiconductor light source that emits light when activated

Lumens: A measure of brightness in which one lumen is equal to the light of a light candle from one foot away

MBS: Minimum Breaking Strength - force required to make the lifting equipment fail or yield, also known as the Minimum Breaking Load (MBL).

MGTW: Maximum Gross Trailer Weight - The largest weight of both trailer and its contents that can be safely towed by a coupling device

Micron: Micrometer = .001mm or .000039 inch equal to 1 thousandth of a millimeter

MVL: Maximum Vertical Load - The maximum recommended static vertical load (down) that can be applied to a coupling device for safe operation.

NPSF: National Pipe Female Swivel

NPSM: National Pipe Swivel Male

NPT: National Pipe Thread

NPTF: National Pipe Thread Fine

PSI: Pounds per square inch

PTO: Power Take off Option

RPM: Revolutions per minute

SAE: Society of Automotive Engineers – set standards for automotive equipment including lighting and towing

SAE J585: Standards for tail lamps

SAE J845: Standards for optical warning devices for authorized emergency, maintenance and service vehicles

SAE J994: Standards for back-up alarms

SST: Stainless Steel

TFT LCD: Thin-Film-Transistor Liquid-Crystal Display

TPI: Threads per inch

UHMW: Ultra High Molecular Weight – highest density polyethylene

UNF: Unified National Fine - thread standard for bolts, nuts and fasteners

VDC: Voltage Direct Current - measurement in a DC system

WLL: Working Load Limit - maximum working load designed by the manufacturer

WOG: Water, oil and gas

Industry Glossary

Class 1: Warning lights are the brightest and primarily reserved for emergency vehicles or other vehicles that may need to demand right of way, warn of an emergency situation or work highly trafficked roadways

Class 2: Warning lights are geared for utility trucks that could be on or off road, but need to provide a significant level of movement notification

SAE J845 and J595: Professional, industry standards for warning lights. Include guidelines for flash timing, photometry, color and environmental requirements (SAE J845 applies to 360 degree beacons and lightbars; SAE J595 applies to directional lights)

California Title 13: State of California has additional requirements that apply specifically to warning lights

PC Rated: Light beam emitted spread out 90 degrees to either side of its centerline for a total of 180 degrees of coverage

IP Rating (Ingress Protection): A two-digit number that follows the code letters "IP" - the first digit represents protection against ingress of solid objects, the second digit represents protection against ingress of liquids (X represents that protection level was not formally tested for that category). The larger the value of each digit, the greater the protection

ICON DEFINITION



The light beam emitted from this light spreads out 90 degrees to either side of its centerline for a total of 180 degrees of coverage



Ingress protection from solids is rated at a 6 meaning that it allows no ingress of dust. Ingress protection from liquids is rated at a 5 meaning that it has protection against low pressure jets of water



Ingress protection from solids is rated at a 6 meaning that it allows no ingress of dust. Ingress protection from liquids is rated at a 6 meaning that it has protection against high pressure jets of water



Ingress protection from solids is rated at a 6 meaning that it allows no ingress of dust. Ingress protection from liquids is rated at a 7 meaning that it has protection against immersion in water between 15cm to 1m deep for 30 minutes



Ingress protection from solids is rated at a 6 meaning that it allows no ingress of dust. Ingress protection from liquids is rated at an 8 meaning that it has protection against immersion in water under pressure for long periods



Ingress protection from solids has not been formally tested. Ingress protection from liquids is rated at a 6 meaning that it has protection against high pressure jets of water



Ingress protection from solids has not been formally tested. Ingress protection from liquids is rated at an 8 meaning that it has protection against immersion in water under pressure for long periods



Meets the industry standards for warning lights to be rated SAE J595 Class 1



Meets the industry standards for warning lights to be rated SAE J595 Class 2



Meets the industry standards for warning lights to be rated SAE J845 Class 1



Meets the industry standards for warning lights to be rated SAE J845 Class 2



Meets the requirements that apply to warning lights in the state of California

BUYERS PRODUCTS WARRANTY POLICY

(please see below for separate LED lighting policies)

Buyers Products warrants all products and hardware manufactured, and/or distributed by it (except those specified) to be free from defects in material and workmanship for a period of one (1) year from date of shipment. Parts must be properly installed and used under normal conditions. Any product which has been altered, including modification, misuse, accident, or lack of maintenance will not be considered under warranty. Normal wear is excluded. The sole responsibility of Buyers Products under this warranty is limited to repairing or replacing any part or part which are returned, prepaid, and are found to be defective by Buyers Products. Authorization from Buyers Products must be obtained before returning any part. No charges for transportation or labor performed on Buyers' products will be allowed under this warranty.

LED LIGHTING

1-YEAR

Buyers Products Company warranties all **Rotating Beacons**, and **Incandescent products** to the original owner against defects in workmanship and material for a period of one (1) year from the date of purchase unless otherwise specified.

5-YEAR

Buyers Products Company warranties all **LED Strobe**, **LED Strip Lights**, **LED Tube Lights**, and **LED Work Light** products to the original owner against defects in workmanship and material for a period of five (5) years from the date of purchase unless otherwise specified.

LIMITED LIFETIME

Buyers Products Company warranties all **DOT LED Lighting** products to the original owner against defects in workmanship and material for the lifetime of the product unless otherwise specified.

Buyers Products must review each warranty claim and reserves the right to offer a refund for the original sale price of the product or replace the defective light. The one (1) year warranty is non-transferable, applies to the original owner, and is subject to the following terms and conditions. The warranty will be void in cases of misuse, severe abuse, and failure to properly install the light. Breakage of the lens or housing, corrosion at the plug, wire wicking, voltage spikes, and product failure caused by road chemicals and acid type washes are not warrantable claims. This warranty gives you specific legal rights and you may also have other legal rights that vary from state to state.

Numerical Index

INDEX

PART NO.	PAGE NO.	PART NO.	PAGE NO.	PART NO.	PAGE NO.	PART NO.	PAGE NO.	PART NO.	PAGE NO.
0091050Z	B33	1308150	E24	1501250	E8	1702405	A6	1703404	A7
0091060Z	B33	1308160	E24	1501260	E8	1702410	A6	1703405	A6
0091405H	B46	1311100	C18	1501310	E10	1702415	A6	1703700	A9
0091410H	B46	1311103	C18	1501311	E10	1702417	A6	1703703	A9
0091415H	B46	1311110	C18	1501400	E9	1702500	A10	1703705	A9
01055	G13	138128	E24	1501410	E9	1702503	A10	1703900	A6, A20
01070	G15	14	L9	1501550	E9	1702505	A10	1704300	A6
01075	G15	1411000	F13	1501675	E10	1702510	A10	1704303	A6
01076	G15	1492100	C3	1501680	E10	1702595	A9	1704305	A6
01077	G15	1492106	C5, C11	15037372	L4	1702600	A9	1704310	A6
01080	G15	1492107	C5, C11	17006	I27	1702603	A9	1704315	A6
01090	G15	1492110	C3	17008	I27	1702605	A9	1704400	A6
01091	G14	1492111	C3	1701000	A11	1702610	A9	1704403	A6
01100	G14	1492112	C3	1701001	A11	1702650	A9	1704405	A6
01120	G14	1492113	C5	1701005	A11	1702653	A9	1704410	A6
01130	G14	1492114	C4	1701005B	A11	1702655	A9	1704415	A6
1	H3	1492115	C4	1701006	A11	1702660	A9	1704600	A9
10025372	L4	1492116	C4	1701006B	A11	1702700	A9	1704605	A9
10032	B5	1492117	C9	1701010	A11	1702703	A9	1704705	A9
10033	B5	1492118	C9	1701010B	A11	1702705	A9	1704710	A9
10036	B3	1492119	C8	1701011	A11	1702710	A9	1704715	A9
10038	B3	1492125	C2	1701011B	A11	1702715	A9	1705100	A4
10040	B4	1492126	C2	1701012	A11	1702725	A9	1705101	A4
10042	B4	1492127	C5	1701015	A11	1702805	A9	1705102	A4
10045	B2	1492128	C9	1701016	A11	1702810	A9	1705103	A4
10050	B2	1492129	C10	1701030	A11	1702815	A9	1705105	A4
10052	B2	1492130	C5	1701031	A11	1702840	A13	1705110	A4
10055	B2	1492134	C8	1701040	A11	1702840TRAY	A13	1705115	A4
10057	B2	1492135	C11	1701041	A11	1702850	A13	1705118	A4
10066	B36	1492137	C10	1701280	A23	1702850TRAY	A13	1705120	A4
10070	B11	1492138	C12	1701281	A23	1702860	A13	1705130	A4
1121272	L4, L7	1492139	C12	1701285	A23	1702860TRAY	A13	1705133	A4
11215	B28	1492145	C2	1701380	A23	1702900	A6	1705135	A4
11220	B28	1492146	C2	1701385	A23	1702905	A6	1705140	A4
11275	B28	1492160	C14	1701551	A12	1702910	A6	1705145	A4
1148	L11	1492161	C14	1701556	A12	1702940	A13	1705147	A4
11840H	L5	1492162	C14	1701561	A12	1702940TRAY	A13	1705148	A4
11840H	L7	1492163	C14	1701565	A12	1702950	A13	1705149	A4
1207R	K19	1492165	C14	1701568	A12	1702950TRAY	A13	1705150	A4
1220R	K19	1492171	C15	1701679	A23	1702960	A13	1705153	A4
1238	K19	1492172	C15	1701680	A23	1702960TRAY	A13	1705160	A4
1250	K19	1492182	C13	1701768	A13	1703100	A7	1705180	A24
12531372	L4	1492183	C13	1702100	A7	1703103	A7	1705181	A24
13006027	E4	1492184	C13	1702103	A7	1703150	A7	1705182	A24
13006039	E4	1492185	C13	1702105	A7	1703203	A7	1705183	A24
1304719	D8	1492190	C10	1702110	A7	1703205	A7	1705190	A24
13060510	I29	1492191	C12	1702115	A7	1703300	A6, A20	1705200	A5
1306070	D8	1492193	C8	1702200	A7	1703303	A6	1705201	A5
1306300	D8	1492194	C8	1702203	A7	1703304	A7	1705203	A5
1306317	D8	1492196	C9	1702205	A7	1703305	A6	1705205	A5
1306505	D8, I29	1492197	C11	1702210	A7	1703310	A6	1705210	A5
1306510	I27	1492215	C4	1702215	A7	1703312	A6	1705215	A5
1306515	D8	1492221	C12	1702235	A5	1703320	A6	1705303	A5
1306600	D8, F7	1492222	C7	1702240	A5	1703322	A6	1705305	A5
1308103	E24	1492223	C6	1702250	A5	1703324	A6	1705310	A5
1308105	E24	1492224	C6	1702295	A6	1703326	A6	1705315	A5
1308106	E24	1492225	C6	1702300	A6	1703328	A6	1705333	A5
1308107	E24	1492226	C7	1702303	A6	1703330	A6	1705335	A5
1308110	E24	1492237	C11	1702305	A6	1703349	A6	1705340	A5
1308111	E24	1492290	C10	1702310	A6	1703350	A6	1705345	A5
1308115	E24	1493215	C4	1702315	A6	1703351	A10	1705350	A5
1308124	E24	1501105	E8	1702317	A6	1703352	A10	1705405	A3
1308125	E24	1501110	E8	1702325	A6	1703353	A6	1705410	A3
1308126	E24	1501150	E8	1702400	A6	1703400	A6, A20	1705415	A3
1308136	E24	1501193	E9	1702403	A6	1703403	A6	1705420	A3

Numerical Index

PART NO.	PAGE NO.	PART NO.	PAGE NO.	PART NO.	PAGE NO.	PART NO.	PAGE NO.	PART NO.	PAGE NO.
1705425	A3	1718030	A19	1734303	A8	1802050	B26	1803415	B24
1705430	A3	1718310	A19	1734305	A8	1802055	B26	1804003	B22
1705435	A3	1718315	A19	1734400	A8	1802056	B26	1804005	B22
1705440	A3	1718320	A19	1734403	A8	1802061	B26	1804007	B22
1705445	A3	1718325	A19	1734405	A8	1802103	B26	1804015	B22
1705450	A3	1718330	A19	1734500	A8	1802105	B26	1804017	B22
1705640	A14	1718410	A19	1734503	A8	1802106	B26	1804030	B21
1705641	A14	1718415	A19	1734505	A8	1802108	B26	1804035	B21
1705650	A14	1718420	A19	1735100	A5	1802110	B26	1804055	B21
1705651	A14	1718425	A19	1735103	A5	1802111	B26	1804060	B22
1705660	A14	1718430	A19	1735105	A5	1802130	B26	1808010	B34
1706400	A3	1720305	A16	1735130	A5	1802131	B26	1809025	B16
1706403	A3	1720308	A16	1735133	A5	1802134	B26	1809027A	B15
1706405	A3	1720315	A16	1735135	A5	1802135	B26	1809029	B15
1706410	A3	1720318	A16	1739305	A17	1802136	B26	1809030B	B15
1706415	A3	1721010	A15	1742300	A3	1802148	B26	1809031A	B15
1706420	A3	1721020	A15	1742303	A3	1802161	B26	1809035A	B15
1706425	A3	1721025	A15	1742305	A3	1802162	B26	1809036	B15
1706430	A3	1721030	A15	1742310	A3	1802167	B26	1809037A	B15
1706500	A3	1721551	A12	1742315	A3	1802168	B26	1809038A	B15
1706503	A3	1721556	A12	1742325	A3	1802175	B26	1809039A	B15
1706505	A3	1721561	A12	1742335	A3	1802200	B19	1809040	B15
1706510	A3	1721565	A12	1742336	A3	1802202	B19	1809042	B15
1706515	A3	1721568	A12	1751651	A12	1802205	B19	1809043	B15
1708310	A6	1722010	A18	1751656	A12	1802207	B19	1809050	B16
1708410	A6	1722305	A16	1751661	A12	1802208	B19	1809055	B16
1709305	A17	1722551	A12	1751663	A12	1802215	B20	1809060A	B15
1709308	A17	1722568	A12	1751664	A12	1802225	B19	1809061A	B15
1709315	A17	1725100	A4	1751665	A12	1802279	B19	1809065	B15
1709318	A17	1725101	A4	1751668	A12	1803005	B23	1809067	B15
1710305	A16	1725103	A4	17757	I27, I29	1803006	B23	1809070	B16
1710308	A16	1725105	A4	1801050	B17	1803007	B23	1809075	B15
1710315	A16	1725110	A4	1801050L	B17	1803010	B23	1809077	B15
1710318	A16	1725115	A4	1801051	B17	1803013	B23	1901006	G9
1711010	A15	1725120	A4	1801051L	B17	1803015	B23	1903005	G11
1711020	A15	1725130	A4	1801052	B17	1803016	B23	1903005LH	G11
1711025	A15	1725133	A4	1801052L	B17	1803017	B23	1903020	G11
1711030	A15	1725135	A4	1801053	B17	1803019	B23	1903030	G11
1711205	A15	1725140	A4	1801055	B17	1803050	B24	1903035	G11
1711206	A15	1725145	A4	1801059	B17	1803051	B24	1903040	G11
1712010	A18	1725150	A4	1801060	B17	1803055	B24	1903050	G14
1712020	A18	1725153	A4	1801060L	B17	1803056	B24	1903052	G14
1712030	A18	1725160	A4	1801100	B18	1803058	B24	1903055	G14
1712035	A18	1725640	A14	1801102	B18	1803059	B24	1903060	G12
1712110	A18	1725641	A14	1801111	B18	1803060	B24	1903065	G12
1712120	A18	1725650	A14	1801119	B18	1803065	B24	1903066	G12
1712200	A5	1725651	A14	1801120	B18	1803075	B24	1903070	G12
1712205	A5	1725660	A14	1801125	B18	1803076	B24	1903110	G14
1712210	A5	1729305	A17	1801208A	B18	1803090	B25	19CH545	H14
1712230	A17	1729308	A17	1801214	B18	1803093	B25	2	H3
1712240	A17	1729315	A17	1801215	B18	1803095	B25	20	K18
1712250	A17	1729318	A17	1801220	B18	1803100CR	B23	2005	G6
1712255	A17	1731020	A15	1801301	B18	1803105	B23	2010	G7
1712260	A17	1732300	A8	1801302	B18	1803110	B23	2020	G5
1715100	A4	1732303	A8	1801310	B18	1803210	B20	2025	G5
1715105	A4	1732305	A8	1801400	B18	1803215	B20	203	I31
1715110	A4	1732310	A8	1801401	B18	1803306	B25	2030	G8
1715115	A4	1732400	A8	1802005	B25	1803306LP	B25	203D42PRPB	I31
1717100	A10	1732403	A8	1802007	B25	1803307	B25	203D4PR42PRPB	I31
1717105	A10	1732405	A8	1802010	B25	1803308	B25	203PB	I31
1717110	A10	1732500	A8	1802015	B25	1803312	B25	204	I31
1718010	A19	1732503	A8	1802020	B25	1803313	B25	2040	G2
1718015	A19	1732505	A8	1802025	B25	1803314	B25	204PB	I31
1718020	A19	1732510	A8	1802026	B25	1803405	B24	204PR	I31
1718025	A19	1734300	A8	1802027	B25	1803410	B24	204PRPB	I31

Numerical Index

PART NO.	PAGE NO.	PART NO.	PAGE NO.	PART NO.	PAGE NO.	PART NO.	PAGE NO.	PART NO.	PAGE NO.
2050	G4	3012035	H8	3024634	C20	3035783	C15	511	L10
2055	G5	3012783	F7	3024635	C20	3035896	C16	515	L10
250	K18	3012784	F13	3024636	C20	3036255	A19	5153XBA	L10
2F12	L14	3012786	F5	3024637	C20	3036256	A19	5153XBA	L6, L7
2F12SCR	L14	3013299	F8	3024638	C20	3036257	A19	516	K18
2F16	L14	3013332	H19	3024639	C20	3036510	A21	5170XBA	L10
2F16SCR	L14	3013395	F12	3024640	C20	3036511	A21	5201000	E15
2F18SCR	L14	3013396	F12	3024642	C20	3036879	F12	5201005	E13, E17
2F20	L14	3013397	F12	3024646	C21	3036900	F5	5201010	E17
2F20SCR	L14	3013398	F12	3024647	C21	3036901	F5	5201012	E17, H6
2F24SCR	L14	3013531	H8	3024648	C21	3037014	A22	5201015	H5
2FS16	L13	3013658	H9	3024649	C21	3037722	E22	5201017	H5
3	H3	3013872	B14	3024713	A11	3039855	H11	5201100	E17
3001894	F13	3014186	D8, F7	3024748	F8	32	L9	5201101	E17
3001895	F13	3014187	D6, F7	3024912	F6	34	L9	5203BBU048	K10
3002713	H13	3014188	D6, F7	3024913	F6	356	K18	5203BBU060	K10
3002879	E15	3014193	C18	3024915	F6	375	K18	5203BBU072	K10
3002880	E15	3014194	C18	3024916	F6	38	L9	5203BBU084	K10
3003081	A11	3014204	K14	3024975	E19	3801000	E33	5203BBU096	K10
3003316	B2, B4	3014217	F7	3025	H17	39LL71	H14	5203BBU108	K10
3003480	A11	3014332	K14	3025044	F12	4	H3	5203BBU120	K10
3004090	E12	3014480	F12	3025442	C21	400	L11	5203BBU132	K10
3004556	A11	3014481	F12	3025622	H27	4005	H28	5203BBU144	K10
3005345	B22	3014677	F12	3025623	H27	400BZ	E22	5203BBU156	K10
3005528	B44	3014981	B11	3025777	E6	400SS	E22	5203BBU168	K10
3005534	I15	3015	H17	3025858	E11	4010	H28	5203BBU192	K10
3005833	H12	3015127	F7	3025859	E11	4025	H13	5203BBU240	K10
3006554	E11	3015862	H41	3025860	E11	403	I31	5203CCU060	K10
3006875	B9	3015863	H41	3025864	E11	4035	H13	5203CCU072	K10
3006909	B17	3016004	F12	3026114	C21	403D44PB	I31	5203CCU084	K10
3008086	A22, H2	3016005	F12	3026115	C21	403D4PR42PRPB	I31	5203CCU096	K10
3008209	F12	3016006	F12	3026116	C21	403PB	I31	5203CCU108	K10
3008210	F12	3016342	C42	3026457	F8	404	I31	5203CCU120	K10
3008225	F13	3016366	E11	3026458	F8	404PB	I31	5203CCU132	K10
3008647	H25	3016367	E11	3026462	F8	404PR	I31	5204BBU072	K10
3008745	H27	3016368	E11	3026586	H27	404PRPB	I31	5230710	H7
3008976	F12	3016369	E11	3027064	A11	405BC	E22	5230912	H8
3009093	G2	3016370	E11	3027065	A11	405BZ	E22	5230915	H8
3009094	F12	3016371	E11	3027070	F13	405SS	E22	5230926	H8
3009095	F12	3016382	E11	3028368	E8	4100	K19	5231112	H8
3009122	A21	3016383	E11	3028392	H27	441466	H37	5231130	H8
3009253	H41	3016508	E19	3028786	H27	450	L11	5231212	H8
3009455	F12	3016666	F5	3028819	G16	455	L11	5231512	H8
3009456	F12	3016667	F5	3029712	F9	4F12SCR	L14	5231515	H8
3009457	F12	3018069	E19	3029916	H27	4F16	L14	5232000	H9
3009458	F12	3018091	B6, B7	3029917	H27	4F16SCR	L14	5232000YEL	H9
3009892	F12	3018195	B10	3029961	C41	4F20	L14	5232001	H9
3009938	A21	3018488	H31	3030	H18	4F20SCR	L14	5232412	H9
3009988	H15	3018538	B17	3030859	I2	4F24	L14	5232417	H8
3010	H17	3020	H17	3030861	I2	4F24SCR	L14	5233000	H9
3010339	H27	3020293	F13	3031692	F8	4F28SCR	L14	5233000YEL	H9
3011034	F12	3020620	B19	3031808	F8	4F30SCR	L14	5233001	H9
3011035	F12	3020919	F7	3032932	C20	4F32SCR	L14	5233612	H9
3011036	F12	3022116	F12	3032933	C20	5	H3	5236585	H7
3011350	F12	3022117	F12	3034110	C15	500	L10	5236586	H7
3011351	F12	3022729	H27	3034278	E15	5051000	E4	5236587	H7
3011352	F12	3022840	H41	3034279	E15	5051100	E4	5401000	E11
3011353	F12	3023432	D10	3034400	C21	5051105	E4	5411000	A24
3011354	F12	3023460	H27	3034842	H30	5051200	E4	5411005	A24
3011868	F5	3023908	E16	3034902	H15	5051205	E4	5411018	A24
3011870	F6	3024237	A11	3035381	F13	5051206	E4	5421012	B30
3011871	F4	3024238	A11	3035509	E19	5051207	E4	5422010	B37, B43
3011873	F4	3024631	C20	3035768	C15	5051210	E4	5422011	B43
3011874	F4	3024632	C20	3035770	C15	5051300	E4	5422012	B37, B43
3011876	F6	3024633	C20	3035781	C15	5051400	E4	5423203	B43

Numerical Index

PART NO.	PAGE NO.	PART NO.	PAGE NO.	PART NO.	PAGE NO.	PART NO.	PAGE NO.	PART NO.	PAGE NO.
5431000	B30	5545396	F3	5613102	B10	5622726	C47	5626101	C51
5471000	B29	5546000	F3	5613200	B10	5622739	C16	5626130	C52
5471001	B29	5546006	F3	5613201	B10	5622754	C60	5626156	C51
5480005	G16	5546300	F3	5613202	B10	5623000	C61	5626191	C16
5480007	G16	5546306	F3	5613300	B10	5623001	C61	5626201	C55
5480010	G16	5546365	F3	5613301	B10	5623050	C48	5626208	C56
5480011	G16	5546366	F3	5613302	B10	5623112	C48	5626209	C56
5480375	G9	5546395	F3	5613303	B10	5623113	C48	5626210	C55
5480417	G16	5546396	F3	5613500	B10	5623122	C48	5626211	C55
5481410	G13	5547000	F3	5620250	C61	5623123	C48	5626292	C16
5482100	G11	5547006	F3	5620251	C61	5623316	C61	5626301	C57
5531000	E2	5547300	F3	5620350	C61	5623317	C61	5626310	C58
5531006	E2	5547306	F3	5620351	C61	5623413	C44	5626311	C58
5531010	E2, E3	5547365	F3	5620352	C61	5623414	C44	5626324	C58
5531020	E2, E3	5547366	F3	5620354	C61	5623423	C44	5626325	C58
5532000	E2	5547395	F3	5620355	C61	5623424	C44	5626352	C17
5534000	E2	5547396	F3	5621002	C16, D6	5623520	C61	5626356	C58
5534006	E2	5548000	F3	5621010	C61	5623521	C61	5626510	C52
5534010	E2, E3	5548006	F3	5621012	C61	5623624	C16	5626520	C53
5534020	E2, E3	5548300	F3	562109166	C16	5623654	C16	5626521	C53
5535000	E3	5548306	F3	562133202	C16	5623711	C48	5626550	C52
5540000	F5	5548365	F3	5621534	C59	5623712	C48	5626551	C52
5540001	F6	5548366	F3	5621711	C49	5623750	C48	5626552	C52
5540002	F6	5548395	F3	5621719	C49	5623755	C16	5626553	C52
5540710	F7	5548396	F3	5621720	C49	5623812	C48	5626700	C53
5541005	F4	5549000	F3	5621812	C16	5623822	C48	5626734	C53
5541006	F4	5549006	F3	5621827	C16	5624050	C50, C51, C55, C56, C57	5626738	C53
5541020	F7	5549300	F3	5621928	C16	5624101	C50	5627501	C44
5541065	F4	5549306	F3	5622032	C59	5624110	C50	5627503	C44
5541095	F4	5549365	F3	5622050	C45	5624118	C51	5627511	C44
5541100	F7	5549366	F3	5622101	C45	5624119	C51	5627512	C44
5541895	F4	5549395	F3	5622102	C45	5624130	C50	5627513	C44
5542000	F9	5549396	F3	5622103	C47	5624130	C50	5627514	C44
5542090	F9	5562001	H38	5622104	C47	5624150	C50	5627517	C44
554250120	F9	5562009	H38	5622130	C59	5624151	C50	5627521	C44
554260140	F9	5562112	H38	5622132	C59	5624156	C50	5627522	C44
554265150	F9	5571000	E6	5622133	C59	5624201	C55	5627523	C44
554270150	F9	5571001	E6	5622134	C59	5624210	C55	5627524	C44
554270152	F9	5571002	E6	5622150	C45	5624251	C55	5627527	C44
554270155	F9	5571003	E6	5622154	C45	5624301	C56	5627532	C44
554270156	F9	5571004	E6	5622201	C45	5624310	C57	5627533	C49
554275150	F9	5571005	E6	5622202	C45	5624324	C57	56296144	C16
554275152	F9	5571006	E6	5622203	C47	5624325	C57	56297145	C16
5543000	F8	5571007	E6	5622204	C47	5624350	C57	56298146	C16
5543006	F8	5571008	E6	5622205	C47	5624352	C17	5651530	C59
5543095	F4	5571200	E6	5622250	C45	5624356	C56	5651700	C49
5543895	F4	5579500	E6	5622254	C45	5624433	C18	5652001	C45
5543965	F4	5601000	D9	5622304	C47	5624832	C16	5652002	C45
5544000	F3	5601005	D9	5622416	C16	5624872	C16	5652030	C60
5544006	F3	5601006	D10	5622436	C16	5624973	C16	5652501	C46
5544300	F3	5601007	D9	5622505	C45, C46, C47	5625030	C17	5652502	C46
5544306	F3	5601010	D9	5622506	C45, C46, C47	5625074	C16	5652511	C47
5544365	F3	5601012	D10	5622512	C45	5625111	C54	5652512	C47
5544366	F3	5601015	D4, F7	5622514	C46	5625115	C53	5652630	C60
5544395	F3	5601016	D4	5622517	C46	5625117	C54	5652720	C47
5544396	F3	5601020	D4	5622522	C45	5625175	C16	5653375	C60
5544621	F8, F10	5601021	D4	5622524	C46	5625215	C56	5653376	C60
5544622	F8, F10	5601025	D4	5622525	C46	5625332	C58	5653701	C48
5545000	F3	5601026	D4	5622526	C46	5625336	C17	5653702	C48
5545006	F3	5601100	D10	5622527	C46	5625337	C17	5654100	C51
5545300	F3	5601101	D10	5622537	C16	5625338	C17	5654300	C57
5545306	F3	5609000	C63	5622550	C46	5625576	C18	5655000	C54
5545365	F3	5609001	C63	5622551	C46	5626050	C51, C52, C53, C55, C56, C57, C58	5655001	C54
5545366	F3	5613100	B10	5622638	C16	5626090	C16	5655100	C54
5545395	F3	5613101A	B10	5622716	C47			5655101	C54

Numerical Index

PART NO.	PAGE NO.	PART NO.	PAGE NO.	PART NO.	PAGE NO.	PART NO.	PAGE NO.	PART NO.	PAGE NO.
5656100	C53	6391209	C21, D5	7381	L3	8590196	E18	8891050	C23
5656300	C58	6391215	D6	7383	L3	8590245	E18	8891052	C23
58R14	H43	6391308	D5, I3	74103	L2	8591000	E19	8891060	C23
58R5	H43	6451000	J7	7412	L2	8591001	E19	8891062	C23
58R5SS	H43	6451005	I3, J7	74123	L2	8591005	E19	8891063	C23
58R5Z	H43	6451010	J7	7413	L2	8591010	E19	8891070	C24
58R6	H43	6451025	J7	74141	L2	8591020	E19	8891071	C24
5910024	E16	6451030	J8	74183	L2	8591040	E18	8891080	C24
60005	I39	6451035	J8	7422	L2	8591050	E18	8891082	C24
60006	I39	6451050	J8	74223	L2	8591060	E18	8891090	C25
60007	I39	6451051	J8	7423	L2	861090	B25	8891091	C25
60008	I39	6451055	J8	74263	L2	8620	B8, B9	8891100	C25
6005	H5	65	K4, K18	74282	L2	871272	L4	8891102	C25
6010	H5	651	K18	74293	L2	8882150	D3	8891104	C32
6015	H4	66000	H30	7432	L2	8883000	D2	8891105	C32
6020	H4	66003	H30	74323	L2	8883010	D2	8891110	C24
6025	H3	66004	H30	74373	L2	8883020	D2	8891111	C24
6030	H3	66006	H30	74393	L2	8883030	D2	8891120	C31
6035	H15	66010	H30	7443	L2	8883040	D2	8891121	C31
6125B	K18	66015	H30	74443	L2	8883101	D3	8891130	C31
6138	K18	66045	H30	74481	L2	8883102	D3	8891131	C31
6170	K18	66050	H30	7452	L2	8883103	D3	8891132	C31
6203BBU048	K11	66051	H30	7453	L2	8883104	D3	8891135	C31
6203BBU060	K11	66053	G10, H30	7463	L2	8883105	D3	8891144	C62
6203BBU072	K11	66054	H30	7493	L2	8883106	D3	8891145	C62
6203BBU084	K11	66056	H30	7622BP	G5, G6, G7	8883108	D3	8891150	C62
6203BBU096	K11	66060	H30	800	L11	8883110	C3	8891166	C62
6203BBU108	K11	66061	H30	8000SSL	H14	8883111	C11	8891167	C62
6203BBU120	K11	66063	H30	8000SSN	H14	8883116	D3	8891168	C62
6203BBU132	K11	66064	H30	801BP	G8	8883132	D3	8891169	C62
6203BBU144	K11	66066	H30	801BPG	G8	8883165	D3	8891177	C62
6203BBU168	K11	66067	H30	815	L11	8883182	D3	8891178	C62
6203BBU216	K11	66070	H30	82123879	E25	8883200	D2	8891200	C37
6203BBU240	K11	66073	H30	82123889	E25	8883211	D3	8891201	C37
6203CCU072	K11	66100	H30	82123899	E25	8890200	C35	8891215	C37
6203CCU084	K11	66101	H30	82123909	E25	8890202	C35	8891216	C37
6203CCU096	K11	66102	H30	82123919	E25	8890300	C28	8891225	C37
6203CCU120	K11	66103	H30	82123929	E25	8890301	C28	8891226	C37
6203CCU204	K11	66105	H30	82123939	E26	8890302	C28	8891227	C37
6241005	I37	66107	H30	82123949	E26	8890305	C28	8891325	C37
6381540	I2	66110	H30	82124269	E26	8890306	C28	8891326	C37
6381541	I2	66111	H30	82124639	E26	8890307	C28	8891327	C37
6381560	I2	66115	H30	82124649	E26	8890308	C28	8891400	C30
6381561	I2	66120	H30	82124659	E26	8890310	C28	8891401	C30
6383060	I3	66122	H30	82124749	E26	8890320	C28	8891402	C30
6383061	I3	66125	H30	851	L11	8890321	C28	8891403	C30
6391001	D5	66127	H30	85104	E7	8891001	C43	8891404	C30
6391002	D5	66128	H30	85106	E7	8891002	C43	8891405	C30
6391003	D5	66129	H30	851105	E7	8891003	C43	8891500	C32
6391004	D5	66130	H30	851111	E7	8891004	C32	8891501	C32
6391005	D9	66135	H30	85141	E7	8891006	C32	8891502	C32
6391050	D9	66150	H30	85142	E7	8891007	C32	8891505	C32
6391100	D6	66155	H30	85152	E7	8891008	C32	8891506	C32
6391101	D5	66160	H30	85162	E7	8891009	C32	8891600	C34
6391102	D6	66170	H30	85166	E7	8891010	C25	8891602	C34
6391103	D6	7312	L3	85176	E7	8891015	C35	8891605	C34
6391104	D5	73122	L3	85177	E7	8891016	D4	8891700	C34
6391105	D6	73133	L3	852	L11	8891018	D4	8891701	C34
6391106	D5	73162	L3	8520	B2, B3, B4, B21	8891024	C26	8891702	C34
6391200	D9	73163	L3	85204	E7	8891025	C26	8891703	C34
6391204	C21, C26, D5	7322	L3	8525	B2, B4	8891040	C22	8891704	C34
6391205	C21, D5	7332	L3	853	L11	8891042	C22	8891705	C34
6391206	C21, D5	73383	L3	8530	B4, B7	8891044	C22	8891706	C34
6391207	C26, D5	7350038	B29	8590017	E18	8891048	C22	8891707	C34
6391208	C21, D5	7351	L3	8590195	E18	8891049	C22	8891709	C34

Numerical Index

PART NO.	PAGE NO.	PART NO.	PAGE NO.	PART NO.	PAGE NO.	PART NO.	PAGE NO.	PART NO.	PAGE NO.
8891710.....	C34	8892600.....	C34	91265.....	B45	B16137BK.....	B36	B239920C.....	H11
8891800.....	C35	8892602.....	C34	91266.....	B45	B16137Z.....	B36	B239936C.....	H11
8891900.....	C29	8892609.....	C34	91269.....	B45	B16140.....	B36	B2399A.....	H11
8891901.....	C29	8892620.....	C34	91310.....	B45	B16140Z.....	B36	B2399B.....	H11
8891902.....	C29	8892700.....	C33	91340.....	B45	B16145.....	B36	B2399B2C.....	H11
8891903.....	C29	8892701.....	C33	91410.....	B46	B18128.....	B36	B2399B6C.....	H11
8891904.....	C29	8892703.....	C33	91415.....	B46	B1812LSP.....	E21	B2399BC.....	H11
8891909.....	C29	8892704.....	C33	91540.....	B35	B18135.....	B36	B2399C.....	H11
8891910.....	C30	8892709.....	C33	91543.....	B35	B1820LSP.....	E21	B2399D.....	H11
8891911.....	C30	8892800.....	C33	91545.....	B35	B20.....	G6	B2399W.....	H11
8891912.....	C30	8892801.....	C33	91550.....	B35	B20135.....	B36	B239CZ.....	H28
8891913.....	C30	8892802.....	C33	91553.....	B35	B20143.....	B36	B23SS.....	G7
8891914.....	C30	8892805.....	C33	91555.....	B35	B20145.....	B36	B2401031.....	L6
8891919.....	C30	8892809.....	C33	91558.....	B35	B2014LSP.....	E21	B2402AL.....	G8
8891920.....	C29, C30	8892810.....	C33	91560.....	B33	B2018LSP.....	E21	B2408W.....	B31
8891921.....	C29, C30	8892900.....	C35	91562.....	B33	B2020LSP.....	E21	B2408W375.....	B31
8891925.....	C29, C30	8892902.....	C35	91595.....	B34	B2024LSP.....	E21	B2408W50.....	B31
8892000.....	C36	8893024.....	C19	91600.....	B35	B2030LSP.....	E21	B2409C.....	B29
8892048.....	C22	88930243.....	C19	91610.....	B44	B206301.....	K14	B2409W375.....	B31
8892110.....	C36	8893049.....	C19	9225.....	F14	B206301001.....	K14	B241103.....	L5
8892200.....	C28	88930492.....	C19	93500.....	B44	B206301002.....	K14	B241103.....	L7
8892201.....	C28	88930493.....	C19	9901000.....	E34	B206301R0.....	K14	B2412LSP.....	E21
8892202.....	C28	8893060.....	C19	9901005.....	E34	B206305.....	K14	B2414LSP.....	E21
8892203.....	C28	88930603.....	C19	9901010.....	E34	B206401.....	K14	B2418ASBC.....	E22
8892204.....	C28	88930604.....	C19	9901015.....	E34	B206401001.....	K14	B2418LSP.....	E21
8892205.....	C28	88930605.....	C19	9901100.....	E34	B21.....	G7	B2420LSP.....	E21
8892206.....	C28	8894037.....	C26	A23.....	H21	B210880.....	C43	B2423F.....	H24
8892207.....	C28	8894047.....	C26	A29.....	H21	B21333.....	L5	B2423G.....	H24
8892208.....	C28	8894050.....	C26	A34.....	H21	B215805.....	H28	B2423H.....	H24
8892209.....	C28	8894055.....	C26	A36.....	H21	B215806.....	H28	B2424SS.....	H24
8892210.....	C28	8894056.....	C26	A41.....	H21	B2159C.....	H28	B2424YC.....	E20
8892225.....	C28	8895095.....	C26	A42.....	H21	B2162E.....	H2	B2426E.....	H25
8892230.....	C27	8895100.....	C26	AC010.....	J3	B2162FF.....	H2	B2426FS.....	H25
8892231.....	C27	8895105.....	C26	AC010B.....	K16	B2162H.....	H2	B2426FSL.....	H25
8892232.....	C27	8895150.....	C26	AC010B3.....	K16	B2162N.....	H2	B2426FSNB.....	H25
8892233.....	C27	8895250.....	C26	AC010M.....	J3	B22329.....	L5	B2426SSCL.....	H24
8892234.....	C27	8895300.....	C26	ACC01.....	K16	B22479.....	L5	B2426SSCR.....	H24
8892239.....	C27	8895350.....	C26	AFSSP080.....	H23	B228357TY.....	L6	B2429X.....	H25
8892240.....	C27	8895400.....	C26, C43	AFSSP100.....	H23	B23.....	G7	B2430W.....	H25
8892241.....	C27	8895404.....	C26, C43	AR014.....	L12	B23128KX.....	L5	B2430YC.....	E20
8892242.....	C27	8895550.....	C25	AR015.....	L12	B23128KX.....	L6, L7	B2432.....	L5
8892243.....	C27	88CH510.....	H14	AS301.....	I22, J5	B23130.....	L5	B2432.....	L7
8892244.....	C27	88CH545.....	H14	AS302.....	I22, J5	B2344.....	H11	B243331.....	L5
8892245.....	C27	900.....	L11	AST460.....	H8	B23505LH.....	G10	B2436ASBC.....	E22
8892246.....	C27	901BP.....	G8	AST60.....	H8	B23505RH.....	G10	B2436YC.....	E20
8892247.....	C27	9031100.....	A18	AST624.....	H8	B23506.....	G10	B24473.....	L5
8892248.....	C27	9031105.....	A18	AST660.....	H8	B23510.....	G10	B2447BZ.....	F14
8892249.....	C27	9031110.....	A18	ATVS100.....	E5	B2351001.....	G10	B2447NHP.....	F14
8892250.....	C27	90M.....	H15	ATVS15A.....	E5	B2351002.....	G10	B2447WAL.....	F14
8892255.....	C27	91050.....	B33	B03822SC.....	B28	B23515.....	G10	B2448.....	F14
8892300.....	C29	91052.....	B33	B03835SC.....	B28	B2373C.....	H5	B2448C.....	F14
8892301.....	C29	91055.....	B33	B0681.....	B31	B2373G.....	H5	B24503.....	L5
8892303.....	C29	91058.....	B33	B076A.....	B32	B2373J.....	H5	B24533.....	L5
8892304.....	C29	91060.....	B33	B08462.....	K22	B2373K.....	H5	B24573.....	L5
8892309.....	C29	91061.....	B33	B1001.....	H38	B2373R.....	H5	B248031.....	L7
8892320.....	C29	91065.....	B33	B1018LSP.....	E21	B2373W.....	H5	B2485AA.....	H11
8892321.....	C29	91091.....	B34	B1018PPB.....	E20	B2374G.....	H5	B2487B.....	H11
8892325.....	C29	91097.....	B34	B1020PPB.....	E20	B2374GZ.....	H5	B24LP.....	E21
8892400.....	C36	91205.....	B44	B117518PPB.....	E20	B2392L.....	H28	B24LXP.....	E21
8892401.....	C36	91210.....	B45	B1218LSP.....	E21	B2394L.....	H28	B24PPY.....	E20
8892403.....	C36	91215.....	B44	B1237PPB.....	E20	B239911P.....	H11	B24PSRPB.....	E20
8892404.....	C36	91220.....	B44	B1237PPW.....	E20	B239914AL.....	H11	B24PSRPW.....	E20
8892420.....	C36	91225.....	B45	B1310.....	L5, L6, L7	B239916AL.....	H11	B24SPP.....	E21
8892425.....	C36	91260.....	B45	B1412LSP.....	E21	B239918AL.....	H11	B24SRP.....	E21
8892500.....	C31	91261.....	B45	B16137.....	B36	B239918C.....	H11	B2575.....	H15

Numerical Index

PART NO.	PAGE NO.	PART NO.	PAGE NO.	PART NO.	PAGE NO.	PART NO.	PAGE NO.	PART NO.	PAGE NO.
B2585B	H4	B27083A14Z	H33	B302845180	K15	B46	G4	BA1	D9
B2585BZ	H4	B27083A14ZKT	H31	B302889	K15	B46BF	G4	BA102	D3
B2586	H16	B27083AZ	H33	B302889M	K15	B48	G4	BA107	D3
B2588B	H3	B27083AZKT	H31	B302890	K15	B50	G5	BA2	D9
B2588BZ	H3	B27084A	H33	B303032	K15	B5055	G5	BA3	D9
B2588W	H3	B27084A12	H33	B303034	K15	B51	G2	BA4	D9
B2589B	H3	B27084A14Z	H33	B303035	I31, K15	B52	G2	BA52	K9
B2589BZ	H3	B27084A14ZKT	H31	B303036	I31	B52150	E19	BA62	K9
B2589W	H3	B27084A56ZKT	H31	B303418F	K15	B52169	E19	BASK16	I22, J5
B2590KZ	H3, H16	B27084A56ZY	H33	B303418R	K15	B5264	H35	BASK16P	I22, J5
B2590LH	H3, H16	B27084AZ	H33	B30LP	E21	B5500	H35	BAV010	H40, J6
B2590RH	H3, H16	B27084AZKT	H31	B30LXP	E21	B5540	H36	BAV015	H40, J6
B2591B	H4	B27085A	H33	B30PPY	E20	B56721	G9	BAV01502	H45
B2591BZ	H4	B27086A14Z	H33	B30PSRPB	E20	B56722	G9	BAV020	H40, J6
B2595	H15	B27086A38ZKT	H31	B30PSRPW	E20	B56723	G9	BAV02002	H45, J6
B2595KZ	H15	B27086A38ZY	H33	B30SPP	E21	B56724	G9	BAV020T	J5
B2595LKB	H15	B27086A56ZKT	H31	B30SRP	E21	B56725	G9	BAV020TD	J5
B2595SH	H15	B27086A56ZY	H33	B31648SC	B28	B56726	G9	BAV030	J4
B2596	H15	B27086ANC	H33	B32F	G7	B56727	G9	BAV030B	J4
B2596KSS	H15	B27086ANCZ	H33	B32SP	G3, H6	B56728	G9	BAV030C	J4
B2596KZ	H15	B27086ANF	H33	B32SPZ	G3, H6	B56729	G9	BAV040	J4
B2596LKB	H15	B27086ANFZ	H33	B33	G8	B56730	G9	BAV050SA	H40, J6
B2596LKBSS	H15	B27086ANFZKT	H31	B36LP	E21	B56730C	G9	BBT0M25P125S	J9
B2596SS	H15	B27086B	H33	B36LXP	E21	B56732	G9	BBT0M25P25S	J9
B2597	H4	B27086C	H32	B36PPY	E20	B56734	G9	BBT0M375P25S	J9
B2598H	H15	B27086EZ	H34	B36PSRPB	E20	B56734BLK	G9	BBT0M375P375S	J9
B2598HU	H15	B27087ANC	H33	B36PSRPW	E20	B56735	G9	BC00M25P125	J9
B2598LP	H15	B27087ANF	H33	B36SPP	E21	B575A	H29	BC00M25P25	J9
B2598SSC	H15	B27087ANFZ	H33	B36SRP	E21	B575CZ	H29	BC00M375P25	J9
B2599LH	H16	B27087B	H33	B38	G2	B575GZ	H29	BC00M375P375	J9
B2599RH	H16	B27087BB	H34	B38RP	G2	B5760	H36	BC12914	K16
B26996A	H34	B27087C	H33	B38S	G3	B6000L	H36	BC2A	B37
B270210EB	H32	B27087CKT	H31	B38SP	G3, H6	B601	G5	BC3AP	B37
B270210EM	H32	B27088ANC	H33	B38W	G2	B601U	G5	BC40	I15
B270210HMZ	H32	B27088ANF	H33	B38ZW	G2	B63322	D8, I28	BC4APD	B37
B270212KM	H32	B27094A	H34	B38ZY	G2	B659KB	K18	BCA16180	I41
B27024BM	H32	B27096A	H34	B39W	G3	B701SM	G5	BCA20180	I41
B27026BM	H32	B27097A	H34	B40	G4	B703	G6	BCHD	B37
B27026EB	H32	B2744A	H8	B4000	H35	B705	G6	BCHD1	B37
B27026EM	H32	B2744S	H8	B40002	I39	B7993	I27	BCHD2	B37
B27026M10	H32	B2797BPC	H7	B40002DC	I39	B7995	I27	BCHF	B37
B27027EB	H32	B2797SS	H7	B40002DP	I39	B801	G8	BCHF1	B37
B27027EKZ	H29	B2797Z	H7	B40003	I39	B801A	G8	BCHF2	B37
B27027EM	H32	B2799B	B31	B40003DC	I39	B801AK	G8	BCHF3	B37
B27028EB	H32	B2799BKT	B31	B40003DP	I39	B8978	B35, B36	BCHGM03	B37
B27028EM	H32	B2800A	B32	B40004	I39	B8979	B35, B36	BCHGM04	B37
B27028LMZ	H32, H43	B2800AB	B32	B40004DC	I39	B9000	H36	BCL500	B34
B27081/210C	H31	B2800AC	B32	B40004DP	I39	B901	G8	BDB12281	B14
B27081/22AZ	H31	B2801A	B32	B40005	I39	B9020	B35, B36	BDB1238	B14
B27081/23AZ	H31	B2801C	B32	B40005DC	I39	B9021	B35, B36	BDB12492H	B14
B27081/24AZ	H31	B284001	H42	B40005DP	I39	B91322SF	L7	BDB125015	B13
B27081/26AZ	H31	B28F	G6	B40006	I39	B91382SF	L7	BDB125015W	B13
B27081/26C	H31	B28SP	G3, H6	B40006DC	I39	B915PPB	E20	BDB12503	B14
B27081/26D	H31	B28SPZ	G3, H6	B40006DP	I39	B93234SC	B28	BDB1385	B13
B27081/27AZ	H31	B3005874	L6	B40B45	D9	B93248SC	B28	BDB13850Z	B13
B27081/27BZ	H31	B302845048	K15	B40LP	E21	B93272SC	B28	BDB1394	B13
B27081/27C	H31	B302845060	K15	B40LXP	E21	B95	H46	BDL253	B14
B27081/28AZ	H31	B302845072	K15	B40MP	G4	B9553SF	L6	BDS52	K8
B270810C	H33	B302845084	K15	B431616U	I41	B95W	H46	BDS62	K8
B27081AZ	H33	B302845096	K15	B432020U	I41	B96W	H46	BE90M25P125	J9
B27081AZKT	H31	B302845108	K15	B432424U	I41	B98596	D8	BE90M25P125S	J9
B27082A	H33	B302845120	K15	B433232U	I41	B9909	B35, B36	BE90M25P25	J9
B27082AZ	H33	B302845132	K15	B434040U	I41	B9912	B35, B36	BE90M25P25S	J9
B27082AZKT	H31	B302845144	K15	B450	F14	B99121	B35, B36	BE90M375P25	J9
B27083A	H33	B302845168	K15	B4500	H35	BA0972	D3	BE90M375P25S	J9

PART NO.	PAGE NO.	PART NO.	PAGE NO.	PART NO.	PAGE NO.	PART NO.	PAGE NO.	PART NO.	PAGE NO.
BE90M375P375	J9	BPU102DMCCW	K12	BTN145	K22	CM004P	I25	DTR6518	F11
BE90M375P375S	J9	BPU102DMCW	K12	BTN145WR	K22	CM004PH	I25	DTR7012	F11
BECO61A	I15	BPUGD	K12	BTN240	K22	CM012P	I25	DTR7015	F11
BECO61AB	I15	BPUGDMCCW	K12	BTN300	K22	CM014P	I25	DTR7015S	F11
BFE12G	L13	BPUGDMCW	K12	BTS	K7	CM032P	I25	DTR7018	F11
BFE16G	L13	BQ52105	K18	BTS062012	H20	CM034P	I25	DTR7018S	F11
BFE20G	L13	BQ62106	K18	BTS072018	H20	CM042P	I25	DTR7020	F11
BH102000	B2	BRA64000	I15	BTS093018	H20	CM044P	I25	DTR7021S	F11
BH102516	B2	BRA64500	I15	BTS123025	H20	CM052P	I25	DTR7022	F11
BH2395AA11	H26	BRB03	B11	BTS124025	H20	CM054P	I25	DTR7512	F11
BH36SF10	I16	BRE32F	K20	BTSS123025	H20	CM062P	I25	DTR7515	F11
BH36SF25	I16	BRE32M	K21	BTSS124025	H20	CM072P	I25	DTR7515S	F11
BH81780	B2	BRE32S	K21	BTT	K8, K9	CM074P	I25	DTR7518	F11
BH82000	B2	BRE52F	K20	BTTT52	K8	CM082P	I25	DTR7520	F11
BH82516	B2	BRE52M	K21	BTTT62	K8	CM084P	I25	DTR7520S	F11
BH850MM	B2	BRE52S	K21	BUCOP25	J9	CM092P	I25	DTR8018	F11
BHC207Z	H19	BRE62F	K20	BUCOP375	J9	CP56	I15	DTR8022	F11
BHC227Z	H19	BRE62M	K21	BUTOP25	J9	CPA56	I15	E22	I17
BHC801Z	H19	BRE62S	K21	BUTOP375	J9	CT150RW	C61	E32	I17
BHEPS4x5	I41	BRE72F	K20	C1010	I21	CT150W12	C61	F1200S	I34
BHEPS5x6	I41	BRE72M	K21	C1010AS	I21	D210	H37	F1200SAE	I34
BHES4x5	I41	BRE72S	K21	C1010DMCCW	I21	D2120	H37	F400B	I34
BHRPS6x5	I41	BRE82F	K20	C1010DMCCWAS	I21	D232	H37	F400S	I34
BJ31	K20	BRE82M	K21	C1010DMCW	I21	D26U	H37	F400SAE	I34
BJ52	K20	BRE82S	K21	C1010DMCWAS	I21	D312	H37	F600S	I34
BJ62	K20	BRTOM25P125	J9	CB1	D7	D324	H37	F600SAE	I34
BJ72	K20	BRTOM25P125S	J9	CB100	D7	D412	H37	F800S	I34
BJ82	K20	BSC3835	B28	CB100PB	D7	D424	H37	F800SAE	I34
BKPT809B	B12	BSC3842	B28	CB102PB	D7	D46	H37	FA025	I14
BL10	H46, I16	BSGD2424	E20	CB120PB	D7	DBV2500	H41	FA038	I14
BLHP125	B27	BSGD2430	E20	CB150	D7	DBV3500	H41	FA050	I14
BLHP200	B27	BSGD2436	E20	CB150PB	D7	DBV900	H41	FA075	I14
BLHP300	B27	BSGS2018	E20	CB151	D7	DH300	H26	FA100	I14
BLHP400	B27	BSGS2030	E20	CB151PB	D7	DH304	H26	FA125	I14
BM2395AA11	H26	BSGS2030	E20	CB152PB	D7	DH500	H27	FA150	I14
BNW015	K4, K18	BSGS2424	E20	CB200PB	D7	DH5006	H27	FA200	I14
BNW016	K18	BSGS2430	E20	CB201	D7	DH5006SS	H27	FBP080	H22
BP100A	B8	BSPT52	K7	CB201PB	D7	DH500SS	H27	FBP080GF	H23
BP125A	B8	BSSPT62	K7	CB202PB	D7	DH501	H27	FBP100	H22
BP141624	A22	BSSPU52	K7	CB251PB	D7	DH502	H27	FBP100GF	H23
BP200	B8	BSSPU62	K7	CB30PB	D7	DKE14JSQ	L13	FBP120GF	H23
BP225	B9	BSV3552	K13	CB50	D7, F7	DLFK50CCW	I13	FBP150	H22
BP760A	B9	BSW002	D6	CB50PB	D7	DLFK50CCW24	I13	FBP150GF	H23
BP824624	A22	BSW050	H40, J6	CB60	D7, F7	DLFK50CCWSM	I13	FDFO12	I14
BP824624B	A20	BSW90030	D6	CB60PB	D7	DLFK70CCW	I13	FDFO25	I14
BP824624W	A20	BTA52	K9	CB62PB	D7	DM0212BF	A11	FDFO38	I14
BP825524	A22	BTA62	K9	CB80PB	D7	DM0212BM	A11	FDFO50	I14
BP826224	A22	BTB030	H42	CB90PB	D7	DM1212B	A11	FDFO75	I14
BP826254	A22	BTD	K8, K9	CBTD41612	G13	DP100	H26	FDFO100	I14
BP855524B	A20	BTI15P	I3	CC400	E11	DP102	H26	FDFO125	I14
BP855524P	A20	BTLO20B2	H42	CC600	E11	DTB102	F10	FDFO150	I14
BP855524W	A20	BTLO30B2	H42	CC800	E11	DTB96	F10	FDFO200	I14
BP855924	A22	BTLO30B656	H42	CCD0714	H41	DTB98A	F10	FDFO250	I14
BP855924B	A20	BTLO30M2	H42	CCD0714SS	H41	DTG	F11	FDFO300	I14
BP855924P	A20	BTN011	K22	CCD1314	H41	DTR	F11	FDFO400	I14
BP855924W	A20	BTN011CPK	K22	CDB01	H38	DTR1	F11	FFO606	I40
BP880	B9	BTN011WR	K22	CDC01Z	H14	DTR4510	E2, E3, F11	FFO608	I40
BP925824	A22	BTN011WRCPK	K22	CH101115	I22	DTR5012	F11	FFO808	I40
BP964824B	A21	BTN015	K22	CH101120	I22	DTR5014	F11	FFO812	I40
BP964824P	A21	BTN015WR	K22	CH102115CCW	I22	DTR5508	E2, E3, F11	FFO8FC	I40
BP964824W	A21	BTN055CPK	K22	CH102115CW	I22	DTR5511	E2, E3, F11	FFO8MC	I40
BPC1010BR	I21	BTN075	K22	CH102120CCW	I22	DTR5514	F11	FFD625SS	H11
BPT	K12	BTN075CPK	K22	CH102120CW	I22	DTR6014	F11	FFD626SS	H11
BPTSG	K12	BTN075WR	K22	CL375	H44	DTR6016	F11	FH000	I43
BPU	K12	BTN075WRCPK	K22	CM002P	I25	DTR6515	F11	FH001	I43

Numerical Index

PART NO.	PAGE NO.	PART NO.	PAGE NO.	PART NO.	PAGE NO.	PART NO.	PAGE NO.	PART NO.	PAGE NO.
FH115	144	H2136153	123	H3269X6X6	151	H5036203	124	H5315X12	154
FH125	144	H2136171	123	H3269X8X4	151	H5036221	123	H5315X12X10	154
FH215	145	H2136173	123	H3269X8X6	151	H5036251	123	H5315X12X16	154
FH225	145	H2136201	123	H3269X8X8	151	H5036253	124	H5315X12X8	154
FH315	146	H2136203	123	H3293X282	L4	H504	123, 124	H5315X16	154
FH325	146	H2550	H24	H3309X12	152	H5105X10	153	H5315X16X20	154
FH415	146	H3	L4	H3309X16	152	H5105X12	153	H5315X4	154
FH425	146	H3013X013	L4	H3309X2	152	H5105X14	153	H5315X4X6	154
FH625	144	H3069X12	151	H3309X4	152	H5105X4	153	H5315X6	154
FH715	145	H3069X12X8	151	H3309X6	152	H5105X6	153	H5315X6X4	154
FH725	145	H3069X16	151	H3309X6X4	152	H5105X8	153	H5315X6X8	154
FM0606	140	H3069X2	151	H3309X8	152	H5129X10	153	H5315X8	154
FM0608	140	H3069X20	151	H3309X8X6	152	H5129X12	153	H5315X8X10	154
FM0808	140	H3069X4	151	H3359X12	152	H5129X14	153	H5315X8X12	154
FM0812	140	H3069X4X2	151	H3359X16	152	H5129X16	153	H5315X8X6	154
FMR8S	111	H3069X6	151	H3359X2	152	H5129X20	153	H5325X10	154
FMR8S3W	111	H3069X6X4	151	H3359X4	152	H5129X4	153	H5325X12	154
FMR8S3WPB	111	H3069X8	151	H3359X6	152	H5129X5	153	H5325X16	154
FMR8S4W	111	H3069X8X4	151	H3359X8	152	H5129X6	153	H5325X4	154
FMR8S4WPB	111	H3069X8X6	151	H3393X393	L4	H5129X8	153	H5325X6	154
FNE031018034	H27	H3109X12X4	151	H3409X12	152	H5134171	124	H5325X8	154
FRL12150	J6	H3109X12X6	151	H3409X16	152	H5134251	124	H5355X12	154
FS012	114	H3109X12X8	151	H3409X2	152	H5165X10	153	H5355X16	154
FS025	114	H3109X16X12	151	H3409X20	152	H5165X12	153	H5355X4X4	154
FS038	114	H3109X16X6	151	H3409X4	152	H5165X16	153	H5355X6	154
FS050	114	H3109X16X8	151	H3409X6	152	H5165X4	153	H5355X8	154
FS075	114	H3109X20X12	151	H3409X8	152	H5165X6	153	H5356X10	154
FS100	114	H3109X20X16	151	H3509X12	152	H5165X8	153	H5356X12	154
FS125	114	H3109X24X20	151	H3509X16	152	H5205X10	153	H5356X16	154
FS150	114	H3109X4X2	151	H3509X2	152	H5205X10X12	153	H5356X6	154
FS200	114	H3109X6X2	151	H3509X20	152	H5205X12	153	H5356X8	154
FS2797CH	H7	H3109X6X4	151	H3509X4	152	H5205X12X16	153	H5365X12	154
FSP050	H22	H3109X8X2	151	H3509X6	152	H5205X12X8	153	H5365X4	154
FSP070	H22	H3109X8X4	151	H3509X8	152	H5205X16	153	H5365X6	154
FSP080	H22	H3109X8X6	151	H3529X12	152	H5205X16X12	153	H5506X10	155
FSP100	H22	H3159X12	151	H3529X16	152	H5205X20	153	H5506X12	155
FSP120	H22	H3159X16	151	H3529X4	152	H5205X4	153	H5506X16	155
FSP150	H22	H3159X2	151	H3529X6	152	H5205X4X4	153	H5506X4	155
FSP200	H22	H3159X4	151	H3529X8	152	H5205X4X6	153	H5506X6	155
FSP260	H22	H3159X6	151	H3559X12	152	H5205X4X8	153	H5506X8	155
FSS070	H23	H3159X8	151	H3609X12	152	H5205X6	153	H5515X10	155
FSS100	H23	H3169X2	151	H3609X4	152	H5205X6X2	153	H5515X12	155
FSSW025	114	H3169X4	151	H3609X8	152	H5205X6X6	153	H5515X16	155
FSSW038	114	H3179X12	151	H3709X12	152	H5205X6X8	153	H5515X6	155
FSSW050	114	H3179X16	151	H3709X16	152	H5205X8	153	H5515X6X8	155
FSSW075	114	H3179X2	151	H3709X2	152	H5205X8X12	153	H5515X8	155
FSSW100	114	H3179X4	151	H3709X20	152	H5205X8X8	153	H5515X8X10	155
FSSW125	114	H3179X6	151	H3709X4	152	H5229X10	153	H5515X8X6	155
FSSW150	114	H3179X8	151	H3709X6	152	H5229X12	153	H5525X8	155
FWD24	B12	H3209X12X8	151	H3709X8	152	H5229X16	153	H5705X6	155
FWD32	B12	H3209X16X12	151	H3759X12	152	H5229X20	153	H5705X8	155
FWD36	B12	H3209X8X4	151	H3759X16	152	H5229X4	153	H5706X12	155
FWRC	B12	H3209X8X6	151	H3759X4	152	H5229X5	153	H5706X16	155
G9003	B11	H3269X10X12	151	H3759X6	152	H5229X6	153	H5706X8	155
G9003UBK	B11	H3269X10X4	151	H3759X8	152	H5229X8	153	H5707X8	155
G9542	B11	H3269X10X6	151	H412538LH	H24	H5255X6	153	H5715X6	155
GPS1	I2, I3, I36	H3269X10X8	151	H412538RH	H24	H5255X8X8	153	H5716X6	155
H101CK	K13	H3269X12X12	151	H412550LH	H24	H5305X10	153	H5716X8	155
H102CKCCW	K13	H3269X12X8	151	H412550RH	H24	H5305X12	153	H5726X6	155
H102CKCW	K13	H3269X16X12	151	H5015X16X12	153	H5305X4	153	H5726X8	155
H2136101	123	H3269X16X16	151	H5015X6X4	153	H5305X6	153	H5924X10	155
H2136103	123	H3269X16X8	151	H5015X8X4	153	H5305X8	153	H5924X12	155
H2136121	123	H3269X20X16	151	H5015X8X6	153	H5315X10	154	H5924X16	155
H2136123	123	H3269X20X20	151	H5036171	123	H5315X10X12	154	H5924X4	155
H2136151	123	H3269X6X4	151	H5036201	123	H5315X10X8	154	H5924X6	155

PART NO.	PAGE NO.	PART NO.	PAGE NO.	PART NO.	PAGE NO.	PART NO.	PAGE NO.	PART NO.	PAGE NO.
H5924X8	155	H9406X8X8X8	156	HCN100	141	HGV250	133	HPGS200	118
H6134171	124	H9455X24X24	156	HCN125	141	HK0509	150	HPGS3	118
H6134251	124	H9455X32X32	156	HCN150	141	HK0709	150	HPGS300	118
H7	L2, L3	H9455X8X8	156	HCN200	141	HK0809	150	HPGS4	118
H7238X10	152	H9515X10X8	156	HCN250	141	HK0913	150	HPGS5	118
H7238X12	152	H9515X12X12	156	HCN300	141	HK1013	150	HPGS500	118
H7238X16	152	H9515X16X16	156	HCR050	135	HK1113	150	HR1250	J6
H7238X2	152	H9515X4X4	156	HCR050SAE	135	HK1213	150	HR3850	J6
H7238X20	152	H9515X6X6	156	HCR075	135	HK1313	150	HRV07516	135
H7238X4	152	H9515X6X8	156	HCV038	141	HK1413	150	HRV07518	135
H7238X6	152	H9515X8X6	156	HCV050	141	HK1513	150	HRV10018	135
H7238X8	152	H9515X8X8	156	HCV075	141	HK1713	150	HRV10025	135
H890X20X16	155	HBF 12P	129	HCV100	141	HK1813	150	HSG075	117
H9100X12X12	156	HBF12	115	HCVD08	135	HK1913	150	HSG100	117
H9100X16X16	156	HBF12P ... I15, I27, I28, I29	129	HCVD08SAE	135	HK2017	150	HSP15P ...I44, I45, I46, I47	147
H9100X4X4	156	HBF16	115	HD200125	119	HK2117	150	HSP15V ...I44, I45, I46	146
H9100X6X6	156	HBF2	115	HDCL252	K9	HK2317	150	HSV050	136
H9100X8X8	156	HBF4	115	HDCL262	K9	HK2517	150	HSV075	136
H9205X12X12	156	HBF6	115	HDCL352	K9	HK2917	150	HSV100	136
H9205X12X16	156	HBF8	115	HDCL362	K9	HK3117	150	HSV1C	136
H9205X12X8	156	HBV025	133	HDS36205	124	HK3317	150	HV020	137
H9205X16X12	156	HBV038	133	HDS36255	124	HK3417	150	HV1030	137
H9205X16X16	156	HBV050	133	HDSSCP012	148	HK3817	150	HV1030EP	136
H9205X20X20	156	HBV075	133	HDSSCP025	148	HLLG1	117	HV1030EPG	136
H9205X24X24	156	HBV100	133	HDSSCP038	148	HM002P	126	HV1030LS	137
H9205X32X32	156	HBV125	133	HDSSCP050	148	HM004P	126	HV1030SAE	137
H9205X4X4	156	HBV150	133	HDSSCP075	148	HM006P	126	HV11AG2ED0	130
H9205X4X6	156	HBV200	133	HDSSCP100	148	HM014P	126	HV11AG00D0	130
H9205X6X4	156	HBV250	133	HDSSCP125	148	HM032P	126	HV11AG00F0	130
H9205X6X6	156	HBV3W038	133	HDSSCT025	149	HM034P	126	HV11BG00D0	130
H9205X6X8	156	HBV3W050	133	HDSST031	149	HM042P	126	HV13AG2ED0	130
H9205X8X12	156	HBV3W075	133	HDSST038	149	HM044P	126	HV13AG00D0	130
H9205X8X6	156	HBV3W100	133	HDSST050	149	HM052P	126	HV13PG00D0	130
H9205X8X8	156	HBVS025	133	HDSST125	149	HM054P	126	HV211AAG2ED0	130
H9255X12X12	156	HBVS038	133	HFA11015	144	HM072P	126	HV211AAG00D0	130
H9255X16X16	156	HBVS050	133	HFA11025	144	HM074P	126	HV231AAG3ED0	130
H9255X8X8	156	HBVS075	133	HFA12515	144	HM082P	126	HV231NAG2ECO	130
H9315X10X12	156	HBVS100	133	HFA12525	144	HM084P	126	HV233AAG2ED0	130
H9315X10X8	156	HBVS125	133	HFA21015	145	HP10	B27, H42	HV25	131
H9315X12X12	156	HC095	150	HFA21025	145	HP11	B27	HV25H	131
H9315X16X16	156	HC100	150	HFA22515	145	HP12	B27	HV3111AAAG2ED0	130
H9315X4X4	156	HC125	150	HFA22525	145	HP13	B27	HV3111AAAG00D0	130
H9315X6X6	156	HC130	150	HFA31015	146	HP16108	141	HV3311NAAG2ECO	130
H9315X6X8	156	HC150	150	HFA31025	146	HP16132	141	HV3331NAAG2ECO	130
H9315X8X6	156	HC155	150	HFA32515	146	HP16144	141	HV515LS	137
H9315X8X8	156	HC160	150	HFA32525	146	HP1660	141	HV715	137
H9355X12X12	156	HC165	150	HFA41015	146	HP1672	141	HV715EP	136
H9355X16X16	156	HC200	150	HFA41025	146	HP1696	141	HV715EPG	136
H9355X20X20	156	HC205	150	HFA42515	146	HP545WC	B27	HV715SAE	137
H9355X4X4	156	HC210	150	HFA42525	146	HP545WCP	B27	HVC020	137
H9355X6X6	156	HC215	150	HFA51025	147	HP6253WC	B27	HVC05	12
H9355X8X8	156	HC220	150	HFA52525	13, 147	HP6253WCP	B27	HVC06	12
H9385X12X12	156	HC250	150	HFA91025	12, 147	HP6256WC	B27	HVC06T	13
H9385X8X8	156	HC260	150	HFA92525	147	HP625SC	B27	HVC1	137
H9405X12X12	156	HC270	150	HFD075	134	HP9	B27	HVC1030	137
H9405X16X16	156	HC280	150	HFD100	134	HPGC100	118	HVC715	137
H9405X20X20	156	HC295	150	HFDL075	134	HPGC160	118	HVE3	132
H9405X4X4	156	HC300	150	HFDL075SAE	134	HPGCB160	118	HVE334PB	132
H9405X4X6	156	HC310	150	HGV038	133	HPGCB300	118	HVE33PB	132
H9405X6X4	156	HC400	150	HGV050	133	HPGP3	118	HVE342PR4PRPB	132
H9405X6X6	156	HC410	150	HGV075	133	HPGP5	118	HVE342PRPB	132
H9405X6X8	156	HC500	150	HGV100	133	HPGS1	118	HVE344PB	132
H9405X8X12	156	HC600	150	HGV125	133	HPGS10	118	HVE34M	132
H9405X8X6	156	HCN050	141	HGV150	133	HPGS100	118	HVE34M3PB	132
H9405X8X8	156	HCN075	141	HGV200	133	HPGS160	118	HVE34PR3PR3PRPB	132

Numerical Index

PART NO.	PAGE NO.	PART NO.	PAGE NO.	PART NO.	PAGE NO.	PART NO.	PAGE NO.	PART NO.	PAGE NO.
HVE3PB.....	I32	L1883.....	H13	LS166572.....	H4	NUT0P25.....	J10	PS15.....	I17
HVE4.....	I32	L1980.....	H13	LS166590.....	H4	NUT0P375.....	J10	PS25.....	I17
HVE42PRPB.....	I32	L3885.....	H13	LT10.....	E12	OP181810.....	E27	PS2501K.....	I17
HVE44.....	I32	L3885RLS.....	H13	LT12.....	E12	OP181815.....	E27	PS2575.....	I17
HVE44PB.....	I32	L3890RLS.....	H12	LT13.....	E12	OP18X18.....	E27	PSK25.....	I16
HVE4PB.....	I32	L38RLSCH545.....	H14	LT15.....	E12	OP18X18P.....	E27	PU303LRS.....	I27
HVE4PR.....	I32	L3980.....	H13	LT20.....	E13	OP18X18R.....	E27	PU304.....	I29
HVE4PRPB.....	I32	L8815.....	H12	LT22.....	E13	OP242410.....	E27	PU304LR.....	I29
HVEH15.....	I32	L8815GO.....	H12	LT25.....	E13	OP242415.....	E27	PU310.....	I29
HVEH9.....	I32	L8816.....	H12	LT30.....	E13	OP242420.....	E27	PU310LR.....	I29
HVESB.....	I2, I32	L8816R.....	H12	LT32.....	E14	OP24X24P.....	E27	PU311.....	I28
HVH15.....	I2	L881XGO.....	H12	LT35.....	E14	OP24X24R.....	E27	PU311LR.....	I28
HVH25.....	I3	L8825.....	H12	LT37.....	E14	P11C.....	B2, B3, B4	PU319.....	I27
HW2000S.....	G12	L8835.....	H12	LT40.....	E14	P12.....	L12	PU319LR.....	I27
HW800S.....	G12	L8855.....	H12	LW10.....	B14	P12SCR.....	L12	PU319LRS.....	I27
K1010AS.....	J4	L8915.....	H12	LW20.....	B14	P14.....	L12	PU3593.....	I27
K1010C.....	J4	LB1.....	C66	LW625.....	B13	P15.....	L12	PU3593LR.....	I27
K1010FAS.....	J4	LB1SS.....	C66	LW847.....	B13	P16.....	L12	PU3593LRV.....	I27
K1010FAS1.....	J4	LB253.....	C66	M3100.....	D7, I27, I28, I29	P16SCR.....	L12	PU5003.....	I28
K1010TAS.....	J4	LB3163.....	C64	M3200.....	D8	P18.....	L12	PU5007.....	I28
K15N.....	L9	LB3163ALDT.....	C64	M3300.....	D7	P18HEX.....	L12	PU526.....	I29
K18N.....	L9	LB3163SLALDT.....	C64	M3400.....	D8	P18SCR.....	L12	PU642.....	I27
K24N.....	L9	LB3163SST.....	C64	MFBH2375A.....	E22	P20.....	L12	PU642LR.....	I27
K5N.....	L9	LB3253.....	C65	MFBH2375F.....	E22	P20SCR.....	L12	PU642LRS.....	I27
K70C.....	J3	LB3253ALDT.....	C65	MFV2375.....	E22	P22SCR.....	L12	QDDC121.....	I38
K70DETCLIP.....	J2	LB3253SST.....	C65	N1883.....	H13	P24.....	L12	QDDC161.....	I38
K70DF.....	J2	LB383.....	C64	N1980.....	H13	P24SCR.....	L12	QDDC201.....	I38
K70DFD.....	I3, J2	LB383ALDT.....	C64	N3885.....	H13	P28SCR.....	L12	QDDC241.....	I38
K70DFNKO.....	J2	LB383ALSM.....	C64	N3980.....	H13	P30SCR.....	L12	QDDP122.....	I38
K70FDA.....	I3, J2	LB383P.....	C64	NB12A.....	L10	P32SCR.....	L12	QDDP162.....	I38
K80.....	J2	LB383SL.....	C64	NB7A.....	L10	P45AC4.....	B6	QDDP202.....	I38
K80D.....	J2	LB383SST.....	C64	NBT0M25P125S.....	J10	P45AC4BK.....	B6	QDWC12.....	I38
K80DF.....	J2	LB384.....	C64	NBT0M25P25S.....	J10	P45AC4K.....	B6	QDWC121.....	I38
K80F.....	J2	LB384SST.....	C64	NBT0M375P375S.....	J10	P45AC4MK.....	B6	QDWC122.....	I38
K85DF.....	J2	LB4663SST.....	C63	NC00M25P125.....	J10	P45AC6.....	B6	QDWC16.....	I38
K85F.....	J2	LB4773SST.....	C63	NC00M25P25.....	J10	P45AC6BK.....	B6	QDWC161.....	I38
K90.....	J2	LB5638.....	G9	NC00M375P25.....	J10	P45AC6K.....	B6	QDWC162.....	I38
K90C.....	J3	LB6123.....	C66	NC00M375P375.....	J10	P45AC6MK.....	B6	QDWC20.....	I38
K90D.....	J2	LB6123ALDT.....	C66	NE90M25P125S.....	J10	P5262.....	K18	QDWC201.....	I38
K90LC.....	J3	LB6123SST.....	C66	NE90M25P25S.....	J10	PB10.....	I22	QDWC202.....	I38
K90TC.....	J3	LB6183.....	C66	NE90M375P25S.....	J10	PH10.....	B3	QDWC24.....	I38
K90TGC.....	J3	LB6183ALDT.....	C66	NE90M375P375S.....	J10	PH15.....	B4	QDWC241.....	I38
KAN.....	L9	LB6183SST.....	C66	NRT0M25P125S.....	J10	PH20.....	B4	QDWC242.....	I38
KBN.....	L9	LB663.....	C65	NT04100.....	J9	PH30.....	B4	QSA62M.....	K7
KCN.....	L9	LB663SL.....	C65	NT04250.....	J9	PH45.....	B4	QSSPU52.....	K6
KP20025.....	B12	LB663SST.....	C65	NT06100.....	J9	PH50.....	B7	QSSPU62.....	K6
KP20031.....	B12	LB8133.....	C65	NT06500.....	J9	PH50AC.....	B7	QTD.....	K7
KP20038.....	B12	LB8443SST.....	C63	NT08100.....	J9	PH50ACMK.....	B7	QTS.....	K6
KP20050.....	B12	LB8445SST.....	C63	NT08500.....	J9	PH55.....	B7	QTS52.....	K6
KPL200.....	B12	LB8663SST.....	C63	NT10100.....	J9	PH55AC.....	B7	QTS62.....	K6
KPL300.....	B12	LB8665SST.....	C63	NT10250.....	J9	PH6.....	B3	QTT.....	K6
KS302.....	L9	LDR02A.....	I2, I16	NT12050.....	J9	PLB11SS.....	C18	R109.....	K2
KS312.....	L9	LDR04.....	I16	NTB04100.....	J9	PLB12SS.....	C18	R21CX06.....	K5
KS402.....	L9	LFK3718.....	I12	NTB06100.....	J9	PM1012.....	B5	R21CX08.....	K5
KS404.....	L9	LFK3724.....	I12	NTG06100.....	J9	PM105.....	B5	R21CX10.....	K5
KS412.....	L9	LFK5018.....	I12	NTR04100.....	J9	PM107.....	B5	R21CX15.....	K5
KS4512.....	L9	LFK5024.....	I12	NTR06100.....	J9	PM25612.....	B5	R38D6X06.....	K4
KS502.....	L9	LL9000.....	H12	NTY04100.....	J9	PM25812.....	B5	R38D6X08.....	K4
KS504.....	L9	LL90003.....	H12	NUC0P25.....	J10	PM812.....	B5	R38D6X10.....	K4
KS512.....	L9	LR1.....	G14	NUC0P375.....	J10	PM84.....	B5	R38D6X12.....	K4
KS5612.....	L9	LS1665120.....	H4	NUC0P500.....	J10	PM87.....	B5	R38D6X15.....	K4
KS602.....	L9	LS1665144.....	H4	NUC0P625.....	J10	PM90.....	B5	R38D6X20.....	K4
KS612.....	L9	LS166545.....	H4	NUC0P750.....	J10	PPM08.....	I16	R38D6X25.....	K4
L001.....	H43	LS166548.....	H4	NUE90P25.....	J10	PPM12.....	I16	R38D6X30.....	K4
L001C.....	H43	LS166554.....	H4	NUE90P375.....	J10	PPM16.....	I16	R38DR3X04.....	K4

PART NO.	PAGE NO.	PART NO.	PAGE NO.	PART NO.	PAGE NO.	PART NO.	PAGE NO.	PART NO.	PAGE NO.
R38DR3X06	K4	RS2W	H10	SG1501048	H8	SMR15SSF25	I10	SW3002003	I19
R38DR3X08	K4	RS2Y	H10	SG2228	E23	SMR15VESS	I11	SW700	D6
R38DR3X10	K4	RS3	H10	SG2229	E23	SMR25AF10	I8	SW710	D6, F7
R38DR3X12	K4	RS3SS	H10	SH2027	L4	SMR25AF25	I8	SW901	D6
R38DR3X15	K4	RS3Y	H10	SH35	H14	SMR25P	I8	SW911	D6
R38LL5X08	K3	RT1251206	B21	SH40	H14	SMR25S	I9	SW9111	D6
R38LL5X10	K3	RT1251206UP	B21	SH675	H42	SMR25SF10	I8	TAF001	I15
R38LL5X12	K3	RT255806	B21	SH675SS	H42	SMR25SF25	I8	TAF001A	I15
R38LL5X15	K3	RT255808	B21	SI1003	I19	SMR30S	I7	TB150BG	E5
R38LL5X20	K3	RT255812	B21	SI1253	I19	SMR30SS	I7	TC0015	I15
R38LLR3X08	K3	RT255818	B21	SI1503	I19	SMR30SS10	I7	TC1002	B38, F7
R38LLR3X10	K3	RT25806B	B21	SI2003	I19	SMR30SS25	I7	TC1004	B38
RAB038025	H45	RT25808	B21	SI2503	I19	SMR30VESS	I11	TC1006	B38
RAB050038	H45	RT25808B	B21	SK10	H45	SMR37S	I7	TC1007	B38
RAB125075	I41	RT25810	B21	SK11	H46	SMR50P	I6	TC1007B	B43
RAB125100	I41	RT25810B	B21	SK12	H45, I3	SMR7S	I10	TC1007P	B39
RAB150125	I41	RT25812	B21	SK14	H46	SMS005BK	I6	TC1007Z	B39
RAB200125	I41	RT25812B	B21	SK16	H46	SMS50S	I6	TC1012	B38, F7
RAB200150	I41	RT25814	B21	SL100	H29	SMS70S	I6	TC1046B	B43
RB102000	B2	RT25814B	B21	SL40AR	C37	SMWLK50ADMCCW	I12	TC1067P	B40
RB102516	B2	RT25818	B21	SL40CR	C37	SMWLK50DMCCW	I12	TC107	B42
RB1780	B2	RT25818B	B21	SL41AR	C37	SMWLK50PDMCCW	I12	TC1077P	B42
RB2000	B2	RT25824	B21	SL475A	C41	SMWLK50PDMCW	I12	TC1242	B43
RB2516	B2	RT25824B	B21	SL480A	C41	SMWLK70ADMCCW	I12	TC1244	B43
RB50MM	B2	RT25836	B21	SL500A	C43	SMWLK70ADMCW	I12	TC1456	B43
RC10L	E16	RT25836B	B21	SL501A	C42	SMWLK70DMCCW	I12	TC1474P	B40
RC10S	E16	RT25848	B21	SL502A	C40	SMWLK70DMCW	I12	TC1770B	B40
RC18PPB	E20	RT25848B	B21	SL550ALP	C39	SS	L9	TC1770P	B40
RC18PPW	E20	RTA252	B21	SL551ALP	C39	SS11	H21	TC1771P	B40
RC24PPB	E20	RTA302	B21	SL585ALP	C39	SS12	H21	TC1774P	B40
RC24PPW	E20	RTD12271F	G13	SL585BLP	C39	SS15	H21	TC1967P	B39
RC30PPB	E20	RTD12271J	G13	SL620ALP	C40	SS15N	H21	TC2002	B38, F7
RC30PPBLU	E20	RTD211218	G13	SL630A	C41	SS16	H21	TC2004	B38
RC30PPR	E20	RTD411218	G13	SL640ALP	C42	SS17	H21	TC2006	B38
RC30PPW	E20	RVA24	B22	SL645ALP	C41	SS18	H21	TC2007	B38
RC36PPB	E20	S41	H21	SL650A	C42	SS19	H21	TC2007P	B39
RC36PPW	E20	S42	H21	SL650A	C38	SS20	H21	TC2007Z	B39
RC40PPB	E20	S43	H21	SL65CO	C38	SS21	H21	TC2012	B38, F7
RC40PPW	E20	S47	H21	SL660A	C42	SS8	H21	TC2061	B38
RC8M	E16	S48	H21	SL665A	C41	SS9	H21	TC2064P	B41
RH4350	E15	S49	H21	SL66AC	C38	SSCH025	I48	TC2074P	B41
RL650A	C43	S50	H21	SL66AG	C38	SSCH038	I48	TC2074T	B41
RLB3812	G9	S5313	H21	SL66AO	C38	SSCH050	I48	TC2075P	B42
RLB5638	G9	S55	H21	SL66CA	C38	SSCH062	I48	TC2076P	B42
RM10	I42	S63	H21	SL66CG	C38	SSCH075	I48	TC2274P	B41
RM10H	B31	S64	H21	SL66GO	C38	SSCH100	I48	TC2967P	B39
RM1225E	B31	S65	H21	SL675ALP	C40	SSCP038	I49	TCH10H	E16
RM12H	B31	S67	H21	SL67AO	C38	SSCP050	I49	TCH10V	E16
RM5P	B3	S72	H21	SL685ALP	C40	SSCP075	I49	TCH12V	E16
RM62000	B2	S73	H21	SL68AC	C38	SSCP100	I49	TDH7512	F11
RM62516	B2	S75	H21	SL68AO	C38	SSCP125	I49	TDH7515	F11
RM650M	B2	SA1	L4	SL695A	C40	SSCT025	I49	TDH7518	F11
RO5B5X06	K5	SA1447WDNH	H4	SL696A	C40	SSCT038	I49	TFA005715	I15
RO5B5X10	K5	SA1454WDNH	H4	SL700A	C39	SSCT050	I49	TFA005715L	I15
RO5B5X15	K5	SA2	L4	SL800A	C39	SSCT062	I49	TFAN3	I2, I3, I15
RO9D3.5X06	K5	SA3	L4	SLH100	H29	SSCT075	I49	TFAN3C	I15
RO9D3.5X10	K5	SA4	L4	SMC35A	I4	SSCT100	I49	TGBE3125	H44
RO9D3.5X15	K5	SAC010B	K16	SMC50A	I4	SSCT125	I49	TGBE3138	H44
RO9D3.5X20	K5	SAC010M	J3	SMC50AR	I4	ST93	G14	TGBE6438	H44
RO9D3.5X25	K5	SBH2	B22	SMC70A	I4	STG1210	E23	TGC02TFK	H45
RO9D3.5X30	K5	SC38B	B29	SMR15S	I9	SW1000503	I19	TGC25006V	H39
RS1	H10	SC44B	B29	SMR15SF10	I9	SW1250753	I19	TGC25006VSPK	H39
RS132715F	G13	SC450C	B29, H44	SMR15SF25	I9	SW1501003	I19	TGC25008C	H39
RS2	H10	SC50B	B29	SMR15SS	I10	SW2001253	I19	TGC25008HMK	H39
RS2SS	H10	SC58B	B29	SMR15SSF10	I10	SW2002003	I3	TGC25008V	H39

Numerical Index

PART NO.	PAGE NO.	PART NO.	PAGE NO.	PART NO.	PAGE NO.
TGC25008VK.....	H39	TSCT038.....	I49	WC091061.....	E32
TGC25008VSPK.....	H39	TSCT062.....	I49	WC100609.....	E33
TGC32506V.....	H39	TSCT075.....	I49	WC1085H.....	E28
TGC32506VK.....	H39	TSCT087.....	I49	WC1086.....	E28
TGC32506VSPK.....	H39	TSCT100.....	I49	WC1086UWH.....	E29
TGC32508HM.....	H39	TSCT125.....	I49	WC1267.....	E32
TGC32508HMKSA.....	H39	U0L3FE.....	I43	WC1467A.....	E30
TGC32508V.....	H39	U1L3FE.....	I44, I45	WC1468A.....	E30
TGC32508VKSA.....	H39	U1L6FE.....	I44, I45	WC151013.....	E33
TGC32508VSPK.....	H39	U3L007.....	I44, I45, I46	WC1588.....	E32
TGCAM0001.....	H44	U3L3FE.....	I45, I46	WC181212.....	E33
TGCAM0002.....	H44	U3L6FE.....	I45, I46	WC24483.....	E30
TGCAM0003.....	H44	U3LWF.....	I42	WC2556A.....	E28
TGCAM0004.....	H44	U3LWF3.....	I42	WC35225.....	E31
TGL3410.....	H43	U3LWF4.....	I42	WC6096A.....	E32
TGL3410HDW.....	H43	U5L3FE.....	I47	WC6810L.....	E28
TGL3410SS.....	H43	U5L6FE.....	I47	WC7118A.....	E32
TGL3410ST.....	H43	U9L3FE.....	I47	WC765.....	E32
TGL34BKT.....	H43	U9L6FE.....	I47	WC786.....	E31
TGL34BKTF.....	H43	UB623512.....	H2	WC796R.....	E30
TGL34BKTS.....	H43	UB623514.....	H2	WC8118.....	E31
TGL34CL.....	H43	UB623516.....	H2	WC8127.....	E31
TGL34CLCS.....	H43	UB623518.....	H2	WC9642Y.....	E31
TGL34CLSS.....	H43	UB623520.....	H2	WCB186.....	E32
TGL34SB.....	H43	UB623522.....	H2	WJ195.....	H17
TGL34SBR.....	H43	UB623524.....	H2	WJ201A.....	H17
TH612714.....	E17	UR35A.....	I5	WJ201SS.....	H17
TH9934.....	E17	UR50A.....	I5	WJ201U.....	H17
TL257M.....	D4	UR50MK.....	I5	WJ202.....	H17
TL382.....	H16	UR50P.....	I4	WJ205.....	H17
TLP100.....	H30	UR50S.....	I5	WJ205RO.....	H17
TLP625.....	H30	UR70A.....	I5	WJ206.....	H17
TLP750.....	H30	UR70S.....	I5	WJ206RO.....	H17
TNP716625750.....	B13	UTVS16.....	E5	WJ208.....	H17
TNP716750100.....	B13	UWLK50ADMCCW.....	I13	WJ208RO.....	H17
TR6211512Z.....	H2	UWLK50ADMCCW.....	I13	WJ211.....	H18
TR6211514.....	H2	UWLK50DMCCW.....	I13	WJ212.....	H18
TR6211516.....	H2	UWLK50DMCW.....	I13	WJ213.....	H18
TR6211518.....	H2	UWLK50PDMCCW.....	I13	WJ215.....	H18
TR6211520.....	H2	UWLK50PDMCW.....	I13	WJ225.....	H19
TR6211522.....	H2	UWLK70ADMCCW.....	I13	WJ96WCB.....	H19
TR6211524.....	H2	UWLK70DMCCW.....	I13	WLH075600.....	I41
TR6211588.....	H2	UWLK70DMCW.....	I13	WLH100120.....	I41
TS15.....	F14	VCGT3100X06.....	K2	WLH100600.....	I41
TS20.....	F14	VCGT3100X10.....	K2	WLH10072.....	I41
TS31.....	F14	VCGT3100X15.....	K2	WLH10096.....	I41
TS41.....	F14	VCGT3100X20.....	K2	WLH125120.....	I41
TS9.....	F14	VCGT3100X25.....	K2	WLH125144.....	I41
TSA13.....	L8	VCGT3100X30.....	K2	WLH125600.....	I41
TSA1360.....	L8	VCGTHO.....	K2	WLH12572.....	I41
TSA1372.....	L8	VCGTX06.....	K2	WN5811Z.....	H29
TSA7.....	L3	VCGTX10.....	K2		
TSCH025.....	I48	VCGTX15.....	K2		
TSCH038.....	I48	VCGTX20.....	K2		
TSCH050.....	I48	VCGTX25.....	K2		
TSCH062.....	I48	VCGTX30.....	K2		
TSCH075.....	I48	VCGTX35.....	K2		
TSCH100.....	I48	VSC1.....	K16		
TSCP025.....	I48	VSC2.....	K16		
TSCP038.....	I48	VSC3.....	K16		
TSCP050.....	I48	VSC4.....	K16		
TSCP075.....	I48	VSK001.....	K17		
TSCP100.....	I48	VSK040.....	K17		
TSCP125.....	I48	WC0888.....	E29		
TSCT025.....	I49	WC091060.....	E32		



DUMP TARP SYSTEMS

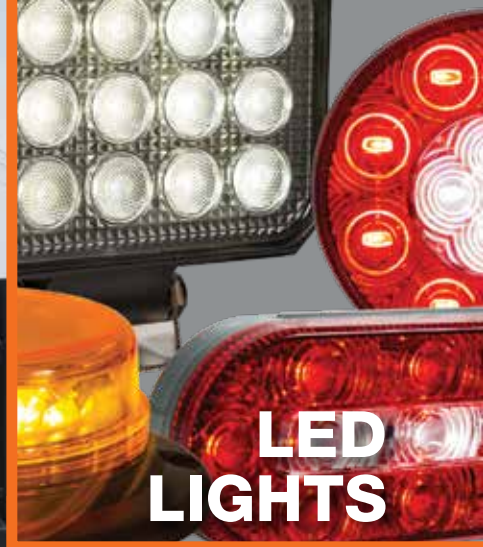

LED LIGHTS



TEXTURED MATTE BLACK BOXES



REAR CAMERA SYSTEMS

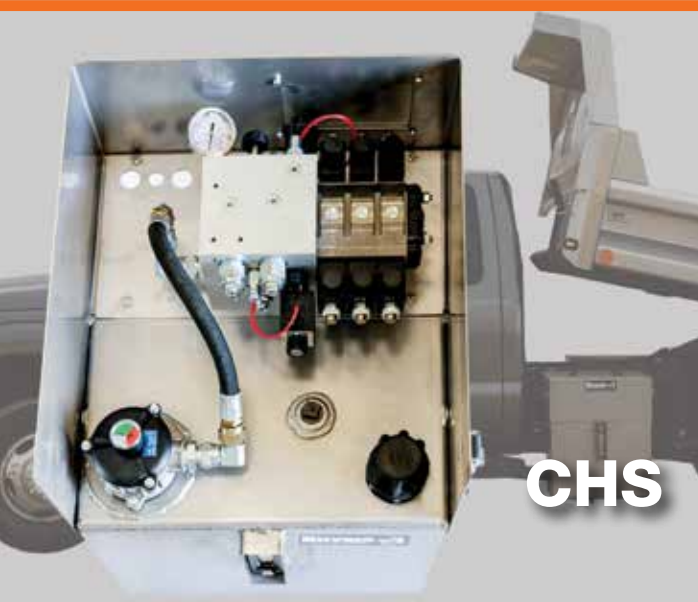

CHS



TOWING

The Buyers family of manufacturing companies

Tracom

 **Boomerang**
RUBBER, INC.

 **Romotech**
Rotational Molding Technologies, Inc.

 **PROGRESSIVE**
POWDER COATING, INC.

www.buyersproducts.com